

## Beosound Balance

Quick guide

Kort vejledning

Snabbguide

Kurzanleitung

Snelgids

Guide rapide

Guía rápida

Guida rapida

Guia de consulta rápida

Краткое Руководство

Stručný návod

Rövid útmutató

Ghid rapid

クイックガイド

간편 안내서

快速指南

快速操作指南

# BANG & OLUFSEN

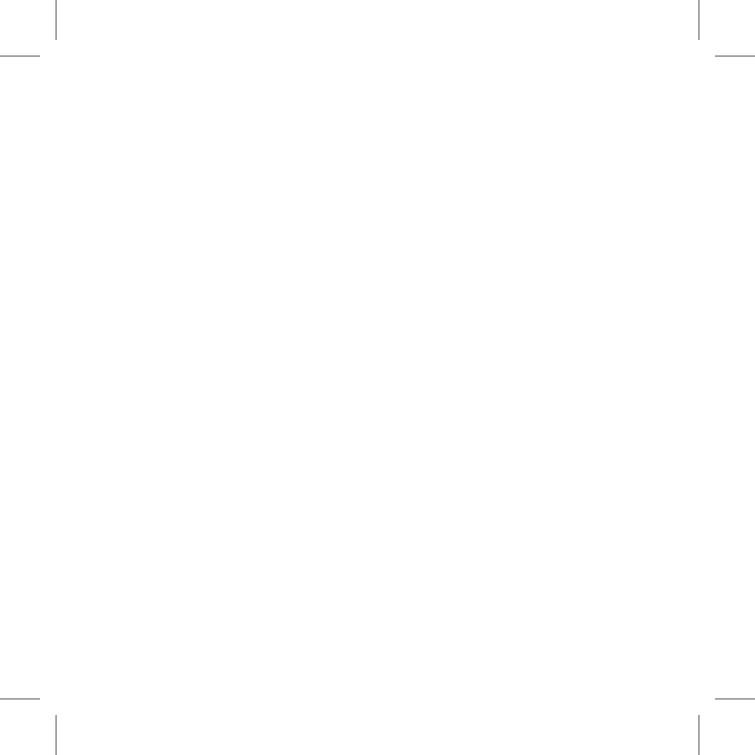

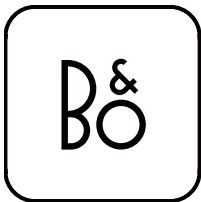

Bang & Olufsen



[Bang-Olufsen.com/APP](https://Bang-Olufsen.com/APP)

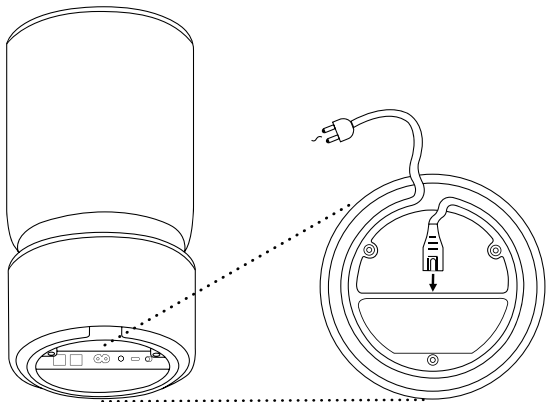



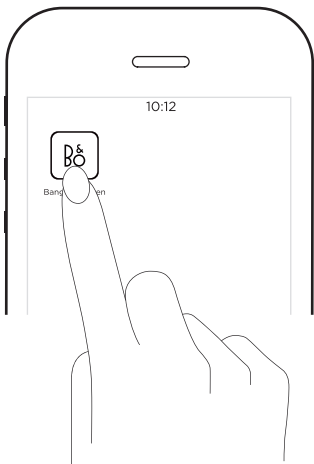

For user guide, see:

Se betjeningsvejledning på:

Användarhandledning finns här:

Die Bedienungsanleitung finden Sie unter:

Voor de gebruikershandleiding, zie:

Pour accéder au manuel de l'utilisateur,  
consultez le site:

Si desea descargar la guía de usuario, visite:

Per la guida utente, vedere:

Para aceder ao manual do utilizador, visite:

Руководство пользователя можно найти по  
ссылке:

Uživatelskou příručku naleznete zde:

A használati útmutatót itt találja:

Pentru ghidul de utilizare, consultați:

ユーザーガイドは次のリンク先をご覧ください。:

사용 설명서는 에서 찾아볼 수 있습니다 :

如要查看用户指南, 请访问:

如需使用指南, 請參閱:

**Bang & Olufsen App**

For AirPlay 2 only users, the speaker can be set up using the Apple Home App.

Kun brugere af AirPlay 2: Højtaleren kan konfigureres ved brug af Apple Home App.

För AirPlay 2 endast användare, kan högtalaren he speaker ställas in med hjälp av Apple Home App.

Nur für AirPlay 2 Benutzer - der Lautsprecher kann mit der Apple Home App eingerichtet werden.

Alleen voor gebruikers van AirPlay: de luidspreker kan worden ingesteld met de Apple Home-app.

Pour les utilisateurs d'AirPlay 2 uniquement, le haut-parleur peut être configuré à l'aide de l'Apple Home App.

Únicamente para los usuarios de AirPlay 2, el altavoz puede configurarse usando Apple Home App.

Solamente per gli utenti AirPlay 2: è possibile configurare il diffusore mediante Apple Home App.

Para utilizadores de apenas AirPlay 2, é possível configurar a coluna utilizando a Apple Home App.

Динамик можно настроить с помощью Apple Home App (только для пользователей AirPlay 2).

Pro uživatele používající pouze AirPlay 2: reproduktor lze nastavit pomocí aplikace Apple Home App.

A csak Airplay 2-es felhasználók az Apple Home App segítségével állíthatják be a hangszórókat.

Doar pentru utilizatorii care folosesc AirPlay 2, difuzorul poate fi configurat folosind Apple Home App.

AirPlay 2 のみのユーザーはスピーカーを Apple Home APP を使って設定できます。

AirPlay 2 전용 사용자의 경우 , Apple Home App 을 사용하여 스피커를 설정할 수 있습니다 .

对于仅使用 AirPlay 2 的用户，可通过 Apple Home App 设置扬声器。

僅針對 AirPlay 2 使用者，可以使用 Apple Home App 進行喇叭設定。

## English

### *Automatic system software update*

In order to ensure that your products have the latest features and improvements, automatic system software updates are enabled by default, and this is the recommended setting.

You may change this at any time in the UPDATE PRODUCT SOFTWARE menu using the Bang & Olufsen App.

### *Log information*

To help us improve our range of available products and services offered to you, we may request certain information from your product about its performance and usage patterns. The information will at all times be provided on an anonymous basis only. You can at any time easily disable this function in the STATUS menu using the Bang & Olufsen App.

## Dansk

### *Automatisk softwareopdatering*

Da vi gerne vil sikre, at du har de seneste funktioner og forbedringer, er automatisk softwareopdatering slået til som standard, og dette er den anbefalede indstilling. Du kan til enhver tid ændre dette i menuen OPDATER PRODUKTSOFTWARE ved hjælp af Bang & Olufsen App.

### *Logoplysninger*

For at forbedre vores udbud af produkter og tjenester kan du blive bedt om bestemte oplysninger vedr. dit produkts ydeevne og din brug af produktet. Disse oplysninger videregives altid kun anonymt. Det er til enhver tid muligt at deaktivere denne funktion i menuen STATUS i Bang & Olufsen App.

## **Svenska**

### *Automatisk systemprogramuppdatering*

För att säkerställa att dina produkter alltid har de senaste funktionerna och förbättringarna är automatiska systemprogramuppdateringar aktiverade som standard och den inställning som rekommenderas. Du kan när som helst ändra inställningen på menyn UPPDATERA PRODUKTENS PROGRAMVARA med hjälp av Bang & Olufsen App.

### *Logga information*

Vi kan begära viss information från din produkt om dess prestanda och användningsmönster för att hjälpa oss att förbättra vårt sortiment av tillgängliga produkter och tjänster som erbjuds. Informationen ska alltid lämnas anonymt. Du kan när som helst enkelt avaktivera denna funktion i menyn STATUS med hjälp av Bang & Olufsen App.

## **Deutsch**

### *Automatische Systemsoftware-Aktualisierung*

Um sicherzustellen, dass Ihre Geräte über die neuesten Funktionen und Verbesserungen verfügen, sind die automatischen Aktualisierungen der Systemsoftware standardmäßig aktiviert. Diese Einstellung wird empfohlen. Sie können diese Einstellung jederzeit über die Bang & Olufsen App im Menü PRODUKTSOFTWARE AKTUALISIEREN ändern.

### *Log-Information*

Um die von uns angebotenen Produkte und Services zu verbessern, werden wir ggf. Informationen zur Leistung Ihres Geräts und des Nutzungsverhaltens abrufen. Die Bereitstellung der entsprechenden Informationen erfolgt vollständig anonym. Sie haben jederzeit die Möglichkeit, diese Funktion über die Bang & Olufsen App im STATUS-Menü zu deaktivieren.



## **Nederlands**

### *Automatische software-update*

Om ervoor te zorgen dat uw producten van de laatste kenmerken en verbeteringen genieten, zijn automatische systeemsoftware-updates standaard ingeschakeld en dit is de aanbevolen instelling. U kunt dit op elk gewenst moment wijzigen in het menu PRODUCTSOFTWARE UPDATEN met behulp van de Bang & Olufsen App

### *Loginformatie*

Om ons te helpen ons assortiment beschikbare producten en diensten te verbeteren, kan het zijn dat we bepaalde informatie over de prestaties en de gebruikspatronen van uw product vragen. De informatie zal altijd uitsluitend anoniem worden gegeven, U kan deze functie te allen tijde uitschakelen in het menu STATUS via de Bang & Olufsen App.

## **Français**

### *Mise à jour automatique du logiciel système*

Afin de garantir que vos produits disposent des dernières fonctionnalités et améliorations, les mises à jour automatiques du logiciel système sont activées par défaut. Il s'agit d'un paramètre recommandé. Vous pouvez modifier ce paramètre à tout moment dans le menu METTRE À JOUR LE LOGICIEL DU PRODUIT à l'aide de l'app Bang & Olufsen.

### *Informations du journal*

Pour nous aider à améliorer notre gamme de produits et services mis à votre disposition, nous sommes susceptibles de vous demander certaines informations sur les performances et l'utilisation de votre produit. Les informations seront fournies à tout moment de manière anonyme uniquement. Vous pouvez à tout moment désactiver facilement cette fonction dans le menu ÉTAT à l'aide de l'app Bang & Olufsen.

## **Español**

### *Actualización automática del software del sistema*

Para garantizar que sus equipos cuenten siempre con las funciones y mejoras más recientes, las actualizaciones automáticas del software del sistema se encuentran habilitadas de forma predeterminada (esta es la configuración recomendada). Puede deshabilitarlas en cualquier momento a través del menú ACTUALIZACIÓN DE SOFTWARE DEL EQUIPO, empleando la aplicación Bang & Olufsen.

### *Información de registro*

Con el fin de mejorar la gama de productos y servicios que ponemos a su disposición, puede que solicitemos al equipo cierta información acerca de su rendimiento y sus patrones de uso. Tal información será recopilada en todo momento con carácter anónimo. Puede deshabilitar esta función cuando lo desee en el menú ESTADO, empleando la aplicación Bang & Olufsen.

## **Italiano**

### *Aggiornamento software di sistema automatico*

Per assicurare che i prodotti siano dotati delle ultime funzioni e miglioramenti, gli aggiornamenti software automatici sono abilitati per impostazione predefinita e questa è l'impostazione consigliata. È possibile modificare questa impostazione in qualsiasi momento nel menu AGGIORNA SOFTWARE PRODOTTO utilizzando l'app Bang & Olufsen.

### *Informazioni registrate*

Per aiutarci a migliorare la nostra gamma di prodotti e servizi offerti, potremmo richiedere determinate informazioni sul prodotto, le sue prestazioni e l'utilizzo. Le informazioni saranno sempre fornite su base anonima. È possibile disattivare questa funzione in qualsiasi momento nel menu STATO utilizzando l'app Bang & Olufsen.

## **Português**

### *Actualização automática do software do sistema*

Para assegurar que os seus produtos possuem as mais recentes funcionalidades e melhorias, as actualizações automáticas de software do sistema estão activadas por defeito e esta é a definição recomendada. Poderá alterar isto em qualquer momento no menu ACTUALIZAÇÃO DE SOFTWARE DO PRODUTO da aplicação Bang & Olufsen.

### *Informações de registo*

Para nos ajudar a melhorar a gama de produtos e serviços que colocamos à sua disposição, poderemos pedir ao seu produto determinadas informações relativas ao respectivo desempenho e padrões de utilização. Estas informações serão sempre fornecidas em modo anónimo. Poderá desactivar esta função em qualquer momento através do menu ESTADO da aplicação Bang & Olufsen.

## Русский

### *Автоматическое обновление системного ПО*

Чтобы обеспечить ваши устройства самыми новыми функциями и улучшениями, автоматическое обновление системного

ПО включено по умолчанию и является рекомендованной настройкой. Вы можете изменить эту настройку в любое время в меню ОБНОВЛЕНИЕ ПРОГРАММНОГО ОБЕСПЕЧЕНИЯ с помощью приложения Bang & Olufsen.

### *Запись информации*

Чтобы помочь нам в улучшении нашей линейки доступных устройств и услуг, предлагаемых вам, мы можем запрашивать из вашего устройства некоторые сведения о его работе и паттернах использования. При этом вся информация всегда будет передаваться только на анонимной основе. Вы можете в любое время легко выключить эту функцию в меню СТАТУС с помощью приложения Bang & Olufsen.

## Čeština

### *Automatické aktualizace systémového softwaru*

Aby bylo zajištěno, že mají vaše výrobky nejnovější funkce a vylepšení, jsou ve výchozím nastavení povoleny automatické aktualizace systémového softwaru, což je i doporučené nastavení.

Toto nastavení můžete kdykoli změnit pomocí aplikace Bang & Olufsen v menu UPDATE PRODUCT SOFTWARE (aktualizace software výrobku).

### *Záznam informací*

Abyste nám pomohli vylepšit rozsah nabízených výrobků a služeb, můžeme vás požádat o určité informace z vašeho výrobku týkající se jeho výkonnosti a způsobů používání. Informace budou vždy poskytovány pouze anonymně. Tuto funkci můžete kdykoli snadno vypnout pomocí aplikace Bang & Olufsen v menu STATUS (stav).

## **Magyar**

### *Automatikus rendszerszoftver frissítések*

Annak érdekében, hogy a termékek a legújabb funkciókkal és innovációkkal rendelkezzenek, a rendszerszoftver frissítések alapértelmezett állapotban engedélyezve vannak, ami egyben ajánlott beállítás is.

Ez a beállítás az UPDATE PRODUCT SOFTWARE (termékszoftver frissítés) menüben bármikor módosítható.

### *Információk rögzítése*

Az általunk kínált termékek és szolgáltatások körének továbbfejlesztése érdekében az Ön által használt termék teljesítményével és használati módjával kapcsolatos információkat kérhetünk Öntől. Az információk átadásra minden esetben kizárólag névtelenül kerül sor. A szóban forgó funkció bármikor könnyen kikapcsolható a Bang & Olufsen alkalmazás STATUS (állapot) menüjében.



## **Română**

### *Actualizarea automată a software-ului sistemului*

Pentru a vă asigura că produsul dvs. are ultimele caracteristici și actualizări, actualizările software automate ale sistemului sunt activate automat, iar aceasta este setarea recomandată. Puteți modifica acest lucru oricând în meniul UPDATE PRODUCT SOFTWARE (ACTUALIZARE SOFTWARE PRODUS) folosind aplicația Bang & Olufsen.

### *Informații jurnal*

Pentru a ne ajuta să îmbunătățim produsele și serviciile disponibile pe care le oferim, este posibil să vă solicităm anumite informații despre performanța și utilizarea produsului. Informațiile vor fi furnizate întotdeauna anonim. Puteți dezactiva cu ușurință această funcție din meniul STATUS (STARE) folosind aplicația Bang & Olufsen.

日本語

### システムソフトウェアの自動更新

最新の機能と改善点がご使用中の製品に確実に反映されるように、推奨設定であるシステムソフトウェアの自動更新機能がデフォルトで有効になっています。この設定は、Bang & Olufsen App を通じて、[製品ソフトウェア更新]メニューからいつでも変更できます。

### ログ情報

当社は提供する製品とサービスをの質を改善するために、その性能と使用形態に関する特定の情報を当社製品から収集することがあります。こうした情報は常に匿名ベースでのみ収集されます。この機能は、Bang & Olufsen App を通じて、ステータスメニューから簡単に無効にできます。

## 한국어

### 자동 시스템 소프트웨어 업데이트

제품에 최신 기능을 설치하고 최적 상태로 유지하기 위해, 자동 시스템 소프트웨어 업데이트는 기본값이 사용함으로 설정되며, 이는 권장 사항입니다. Bang & Olufsen App을 사용하여 제품 소프트웨어 업데이트 메뉴에서 언제든지 설정을 바꿀 수 있습니다.

### 로그인 정보

B&O는 제공해 드린 제품이나 서비스의 품질과 종류를 개선하기 위하여 고객 여러분께 제품의 성능과 사용 패턴에 관한 특정 정보를 요청할 수 있습니다. 제공해주신 정보는 언제나 익명으로 처리됩니다. 이 기능은 Bang & Olufsen App의 상태 메뉴에서 언제든지 취소할 수 있습니다.

## 简体中文

### 系统软件自动更新

为确保您的产品获得最新的功能和更新，默认会启用系统软件自动更新功能，建议保留此设置。您可以随时使用 Bang & Olufsen App 在“更新产品软件”菜单中更改此设置。

### 记录信息

为帮助我们改进产品和服务，我们可能会请求从您的产品获取有关其性能和使用情况的信息。这些信息将始终以匿名方式传输。您可以随时使用 Bang & Olufsen App 在“状态”菜单中禁用此功能。

## 繁體中文

### 系統軟體自動更新

為確保您的產品享有最新功能和改良功能，系統軟體自動更新預設為啟用，且為建議設定。您可在 [更新產品軟體] 選單中使用 Bang & Olufsen App，隨時變更此設定。

### 登入資訊

如要協助我們改善給您的產品與服務，請您提供有關產品性能和使用型態等特定資訊。您的資訊僅會匿名提供。您可隨時在 [狀態] 選單中使用 Bang & Olufsen App，輕鬆停用此功能。

The Wi-Fi CERTIFIED™ Logo is a certification mark of Wi-Fi Alliance®.



The Bluetooth® word mark and logos are registered trade-marks owned by Bluetooth SIG, Inc. and any use of such marks by Bang & Olufsen group is under license. Other trade-marks and trade names are those of their respective owners.



Tilmeld Dig Online  
Registrieren Sie Sich Online  
Register Online  
Registro En Línea  
Inscription En Ligne  
Registrazione On-line  
オンライン登録  
온라인 등록  
Online Registreren  
Registo Online  
Онлайн Регистрация  
Online-registrering  
在线注册  
線上註冊

**DA** Tilmeld dig online på [www.bang-olufsen.com/register-product](http://www.bang-olufsen.com/register-product) for at modtage vigtige oplysninger om produkt- og softwareopdateringer fra BANG & OLUFSEN Group. Hvis du har købt dit produkt i en BANG & OLUFSEN-butik eller på [www.bang-olufsen.com](http://www.bang-olufsen.com), er du automatisk blevet tilmeldt.

**DE** Registrieren Sie sich online unter [www.bang-olufsen.com/register-product](http://www.bang-olufsen.com/register-product), um wichtige Informationen zu Produkt- und Software-Aktualisierungen sowie interessante Neuigkeiten und Angebote von der BANG & OLUFSEN Gruppe zu erhalten. Wenn Sie ein Produkt in einem BANG & OLUFSEN Fachgeschäft oder auf [www.bang-olufsen.com](http://www.bang-olufsen.com) gekauft haben, sind Sie bereits registriert.

**EN** Register online at [www.bang-olufsen.com/register-product](http://www.bang-olufsen.com/register-product) to receive important information about product and software updates – and to get exciting news and offers from the BANG & OLUFSEN Group. If you have purchased your product at a BANG & OLUFSEN store or at [www.bang-olufsen.com](http://www.bang-olufsen.com), you have automatically been registered.

**ES** Regístrate online en la página web [www.bang-olufsen.com/register-product](http://www.bang-olufsen.com/register-product) para recibir información importante acerca del productos y de actualizaciones de software – y para conseguir fantásticas noticias y ofertas del Grupo BANG & OLUFSEN. Si ha adquirido el equipo en una tienda BANG & OLUFSEN o en [www.bang-olufsen.com](http://www.bang-olufsen.com), se habrá registrado automáticamente.



Inscrivez-vous en ligne sur [www.bang-olufsen.com/register-product](http://www.bang-olufsen.com/register-product) pour recevoir des informations importantes sur les mises à jour de produits et de logiciels - et pour obtenir des nouvelles et des offres intéressantes du Groupe BANG & OLUFSEN. Si vous avez acheté votre produit dans un magasin BANG & OLUFSEN ou sur [www.bang-olufsen.com](http://www.bang-olufsen.com), vous avez été inscrit automatiquement.

FR

Registrarsi online su [www.bang-olufsen.com/register-product](http://www.bang-olufsen.com/register-product) per ricevere importanti informazioni su prodotti e aggiornamenti software, notizie e le fantastiche offerte del Gruppo BANG & OLUFSEN. Se hai acquistato il tuo prodotto in un punto vendita BANG & OLUFSEN o su [www.bang-olufsen.com](http://www.bang-olufsen.com), la registrazione è automatica.

IT

[www.bang-olufsen.com/register-product](http://www.bang-olufsen.com/register-product) にご登録されれば、製品とソフトウェアの更新に関する重要な情報についてお知らせいたします。さらには BANG & OLUFSEN Group からのホットなニュースやオファーもご利用になれます。BANG & OLUFSEN ストアまたは [www.bang-olufsen.com](http://www.bang-olufsen.com) にて商品をご購入されたお客様はすでに登録済です。

JA

제품 및 소프트웨어에 관한 중요 정보를 수신하고 BANG & OLUFSEN 그룹으로 뉴스와 특별 혜택 소식을 받아보려면 [www.bang-olufsen.com/register-product](http://www.bang-olufsen.com/register-product)에서 온라인으로 등록하십시오. BANG & OLUFSEN 대리점 또는 [www.bang-olufsen.com](http://www.bang-olufsen.com)에서 제품을 구입하신 고객은 자동으로 등록됩니다.

KO

**NL** Registreer online op [www.bang-olufsen.com/register-product](http://www.bang-olufsen.com/register-product) om belangrijke informatie te ontvangen over product- en software-updates - en om de laatste nieuwtjes en aanbiedingen van de BANG & OLUFSEN Group te ontvangen. Als u uw product in een BANG & OLUFSEN-winkel of op [www.bang-olufsen.com](http://www.bang-olufsen.com) hebt gekocht, bent u automatisch geregistreerd.

**PT** Registe-se online em [www.bang-olufsen.com/register-product](http://www.bang-olufsen.com/register-product) para receber informações importantes sobre atualizações de produtos e software, e para receber notícias e ofertas entusiasmantes do Grupo BANG & OLUFSEN. Se adquiriu o seu produto numa loja BANG & OLUFSEN ou em [www.bang-olufsen.com](http://www.bang-olufsen.com), foi automaticamente registado.

**RU** Зарегистрируйтесь на сайте [www.bang-olufsen.com/register-product](http://www.bang-olufsen.com/register-product) для получения важной информации о продукции и доступных обновлениях программного обеспечения, новостей и выгодных предложений группы BANG & OLUFSEN. Если вы приобрели свой продукт в магазине BANG & OLUFSEN или на сайте [www.bang-olufsen.com](http://www.bang-olufsen.com), то вы были зарегистрированы автоматически.

**SV** Registrera dig online på [www.bang-olufsen.com/register-product](http://www.bang-olufsen.com/register-product) för att få viktig information om produkter och programuppdateringar samt för att få spännande nyheter och erbjudanden från BANG & OLUFSEN Group. Om du har köpt din produkt i en BANG & OLUFSEN-affär eller hos [www.bang-olufsen.com](http://www.bang-olufsen.com) behöver du inte registrera dig, eftersom registreringerna redan har utförts automatiskt.

在线注册[www.bang-olufsen.com/register-product](http://www.bang-olufsen.com/register-product)，以接收有关产品和软件更新的重要信息，以及获得BANG & OLUFSEN Group令人兴奋的新闻与优惠。如果您从 BANG & OLUFSEN 商店或 [www.bang-olufsen.com](http://www.bang-olufsen.com) 购入产品，即已自动注册。

ZH

請上 [www.bang-olufsen.com/register-product](http://www.bang-olufsen.com/register-product) 註冊，以取得有關產品與軟體更新的重要資訊 — 以及獲得來自 BANG & OLUFSEN 集團的重要新聞與優惠。如果您的產品是在 BANG & OLUFSEN 店面或 [www.bang-olufsen.com](http://www.bang-olufsen.com) 購買，即已自動獲得註冊。

ZHTW

[www.bang-olufsen.com/support/beosound-balance](http://www.bang-olufsen.com/support/beosound-balance)

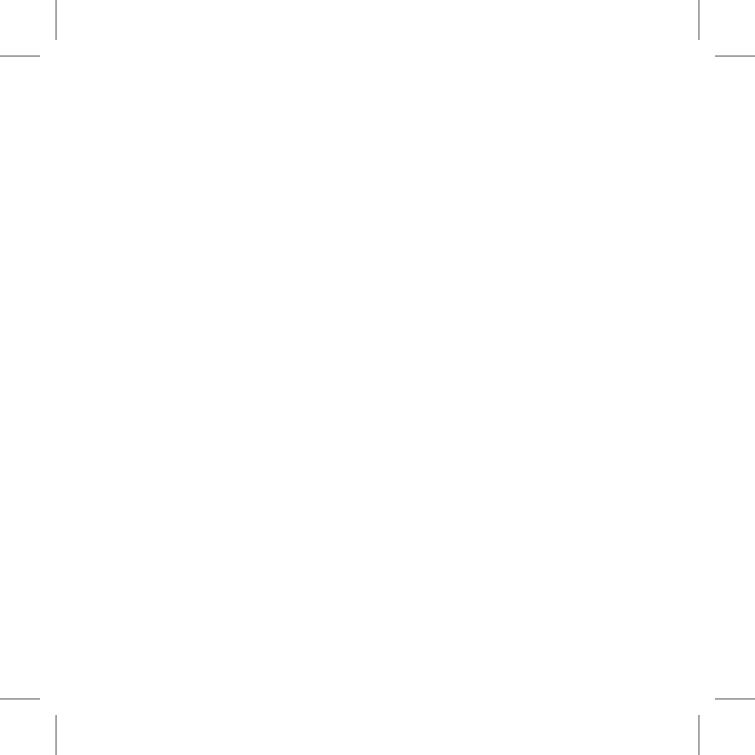

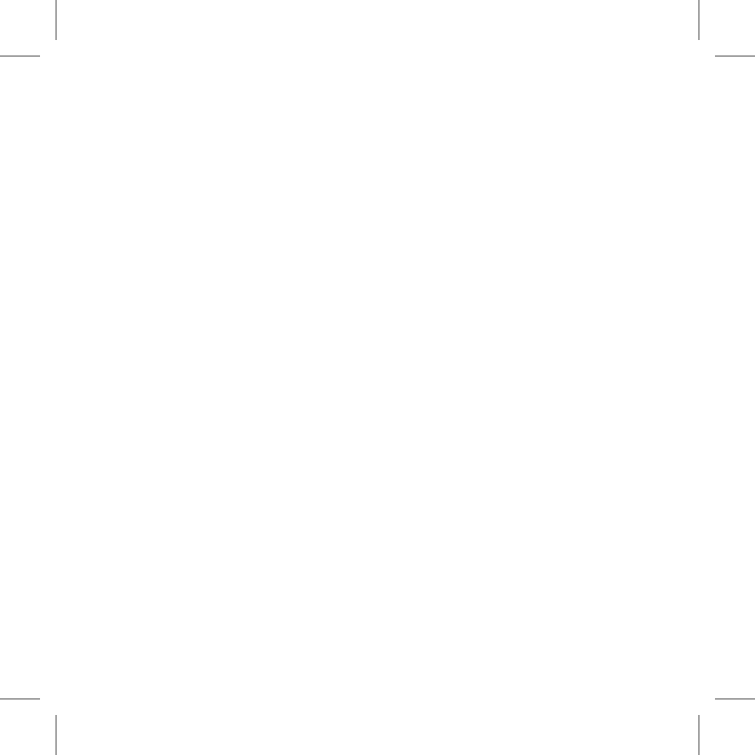

**For the People's Republic of China market only:** The Warranty only applies to Bang & Olufsen Products imported by Bang & Olufsen Enterprise Management (Shanghai) Co. Ltd. and purchased from Authorised Resellers selling from physical stores located or authorized online stores hosted in the People's Republic of China or legally imported in connection with an end-user's properly documented relocation to the People's Republic of China. Bang & Olufsen Products purchased in Hong Kong, Macau or Taiwan or elsewhere outside the People's Republic of China are excluded from the Warranty but subject to the applicable legislation in the relevant market of purchase. Import, sale and use of specific Bang & Olufsen Products in the People's Republic of China is subject to China Compulsory Certification (CCC), obtained from the above mentioned authorized stores located or hosted in the People's Republic of China at the time of purchase or upon appropriate documentation of relocation to the People's Republic of China for Bang & Olufsen Products purchased abroad.

**For Hong Kong and Macau markets only:** The Warranty only applies to Bang & Olufsen Products imported by Bang & Olufsen Limited and purchased from authorized physical stores located or authorized online stores hosted in Hong Kong or Macau, or legally imported in connection with an end-user's properly documented relocation to Hong Kong or Macau. Bang & Olufsen Products purchased outside Hong Kong or Macau are excluded from the Warranty but subject to the applicable legislation in the relevant market of purchase.

to create an express warranty of any kind with respect to the Bang & Olufsen Product. No agent, employee, dealer, representative or reseller is authorized to modify or extend this Warranty or to make binding representations or claims, whether in advertising, presentations or otherwise, on behalf of Bang & Olufsen regarding the Bang & Olufsen Products or this Warranty.

**Severability**  
If any portion of this Warranty is held to be illegal or unenforceable, such partial illegality or unenforceability shall not affect the enforceability of the remainder of the Warranty.

**Consumer's legal rights**  
This Warranty is provided in addition to the rights and remedies granted by the seller of the Bang & Olufsen Product or granted under applicable legislation. Any and all remedies (e.g. rectification, claim for damages, and/or right to terminate the contract) granted by the seller of the Bang & Olufsen Product or available by law remain unaffected by this Warranty.

**For the Australian market only:** Bang & Olufsen Products are subject to the guarantees provided under the Australian Consumer Law. You are entitled to a replacement or refund for a 'major problem' and for compensation for any other reasonably foreseeable loss or damage. You are also entitled to have the Bang & Olufsen Product repaired or replaced if the Bang & Olufsen Product fails to be of acceptable quality and the problem does not amount to a 'major problem';

**For the US market only:** Some states do not allow the exclusion or limitation of incidental or consequential damages. Thus, the above limitations or exclusions may not apply to you. This Warranty gives you specific legal rights, and you may also have other rights which vary from state to state.

in countries with governmental requirements on specifically developed versions of Bang & Olufsen products, e.g. due to varying transmission systems and approval demands, and the defect or malfunction is caused by the usage of other versions than required in the specific country, this Warranty does not apply. To obtain information about usage of the Bang & Olufsen Product in several countries, please contact the legal entity stated on the original invoice for the Bang & Olufsen Product.

All implied warranties, including without limitation, implied warranties of merchantability and fitness for a particular purpose, are limited to the duration of this Warranty. In no event shall Bang & Olufsen be liable for damages in excess of the purchase price of the Bang & Olufsen Product or for, without limitation, commercial loss or any sort; loss of use, time, data, reputation, opportunity, goodwill, profits or savings; inconvenience; incidental, special, consequential or punitive damages; or damages arising from the use or inability to use the Bang & Olufsen Product.

Bang & Olufsen makes no warranties or representations, express or implied, statutory or otherwise, as to the quality, capabilities, operations, performance or suitability of any third-party software or equipment used in conjunction with the Bang & Olufsen Product, or the ability to integrate any such software or equipment with the Bang & Olufsen Product, whether such third-party software or equipment is included with the Bang & Olufsen Product distributed by Bang & Olufsen or otherwise. Responsibility for the quality, capabilities, operations, performance and suitability of any such third-party software or equipment rests solely with the user and the direct vendor, owner or supplier of such third-party software or equipment. Nothing contained in the user manual or any other document shall be construed



- Defects in consumables (i.e. components that are expected to require regular replacement such as but not limited to batteries) as well as defects caused by overcharging;
  - Unreasonable costs or expenses related to modifications or demonstrations of the space in which the Bang & Olufsen Product is placed during the process of repair; and/or
  - Costs for cleaning the screen due to external influences.
- Defects claimed under the Warranty are rectified at Bang & Olufsen's discretion within the rules of the marketing and consumer law.
- Rectification is ensured by way of (i) repairing the defective Bang & Olufsen Product, (ii) inserting remanufactured parts into the Bang & Olufsen Product, and/or (iii) replacing the Bang & Olufsen Product with a new product equivalent in performance and reliability to the Bang & Olufsen Product. Replacement of limited or special edition Bang & Olufsen Products depends on the availability of the Bang & Olufsen Products in question. Where the Bang & Olufsen Product cannot be repaired (damage is considered as total loss) and where exchange is not feasible, compensation is offered on a pro-rata basis of the purchase price.
- All exchange modules become property of Bang & Olufsen.
- Exclusions and limitations**
- Bang & Olufsen is not liable for the damage or loss of any programs, data and/or media content during the repair process. Bang & Olufsen strongly recommends customers to ensure that, if possible, all data is backed up prior to requesting repair services from Bang & Olufsen. The Warranty will not operate if the serial number has been defaced or altered or if non-authorized modifications in the software have been made.

This Warranty is conditioned upon proper use of the Bang & Olufsen Product within the Warranty Period. The Warranty does not cover:

- Defects which have been caused by wrongful use, incorrect and/or unauthorized installation, incorrect repairs/modifications, or maladjustment of the Bang & Olufsen Product, or neglect, including but not limited to "burn in" of plasma or OLED displays, overdriving of speakers and similar wrongful use;
- Defects resulting from usage of the Bang & Olufsen Product in conjunction with accessories that are not approved by Bang & Olufsen;
- Defects which have been caused by lightning, fire, water, voltage fluctuations, improper ventilation or other events of force majeure beyond the control of Bang & Olufsen;
- Consequential damage, indirect or direct loss or any related expenses claimed under the Warranty, such as but not limited to loss from inability to operate the Bang & Olufsen Product or costs connected with rent of substitution products;
- Software and content provided by third parties or problems occurring due to modifications made by the software provider;
- Field assistance for problems that can be solved with online software updates. It is the customer's responsibility to provide network connection for these updates;
- Problems occurring with network/wireless connection caused by external effects present locally only and not impacting functionality in other locations not experiencing such external effects. To obtain information about the functionality of specific purposes, please contact Bang & Olufsen;

## **General Conditions**

Genuine Bang & Olufsen products ("Bang & Olufsen Products") are covered by this limited warranty (the "Warranty"). The terms of this Warranty apply to Bang & Olufsen Products purchased in or after November 2019. To claim any rights under this Warranty, the original invoice received at the time of purchase of the Bang & Olufsen Product must be presented to Bang & Olufsen.

This Warranty covers all defects (relevant to the specification of the Bang & Olufsen Product in question) that may arise in the Bang & Olufsen Product within the warranty period. The warranty period commences upon the date of purchase by the first consumer purchaser and continues for the following 36 months after that date (the "Warranty Period").

If a defect covered by the Warranty arises within the Warranty Period and your Bang & Olufsen Product is applicable for online return, please make your claim at: <https://www.bang-olufsen.com/support>

If the online return tool is not available in your country or if the Bang & Olufsen Product is not applicable for the tool, please contact the legal entity stated on the original invoice for the Bang & Olufsen Product.

## **Coverage**

Bang & Olufsen warrants that the Bang & Olufsen Product is free from defects in material and workmanship under normal use and service for the Warranty Period.

Bang & Olufsen Products are products of superior design and craftsmanship and should be treated with care. Procedures and suggestions on proper use and maintenance of Bang & Olufsen Products and its internal components should always be followed.

B&O-produkter som marknadsförs av B&O PLAY A/S och som köps i detaljerad återförsäljare omfattas av en begränsad garanti. B&O-producter som marknadsförs av B&O PLAY A/S och som köps i detaljerad information om den här begränsade garantins omfattning och dess begränsade giltighetstid finns på [www.bang-olufsen.com/limited-warranty](http://www.bang-olufsen.com/limited-warranty).

გადასაყენებლად B&O PLAY A/S-ის პროდუქტები, რომლებიც გადამყიდველს შეიძლება მიუწოდოს, უნდა იყოს დაფარული B&O PLAY A/S-ის ვებ-გვერდზე [www.bang-olufsen.com/limited-warranty](http://www.bang-olufsen.com/limited-warranty).

B&O PLAY A/S tarafından satılan ve yetkili satıcıdan alınan olan B&O ürünleri sınırlı garanti kapsamındadır. Bu sınırlı garanti'nin kapsamı ve sınırlı süresi hakkında ayrıntılı bilgi için [www.bang-olufsen.com/limited-warranty](http://www.bang-olufsen.com/limited-warranty) adresini ziyaret edebilirsiniz.

由 B&O PLAY A/S 销售并从授权零售商处购买的 B & O 产品享有有限保修。如需详细了解此有限保修政策的保修范围及其保修时限、请访问 [www.bang-olufsen.com/limited-warranty](http://www.bang-olufsen.com/limited-warranty)。

由 B&O PLAY A/S 行銷，以及購買自授權零售商的 B&O 產品享有有限保固。如需此有限保固涵蓋範圍的詳細資訊、以及保固的期間、請至 [www.bang-olufsen.com/limited-warranty](http://www.bang-olufsen.com/limited-warranty)。

**PL**

Produkcje B&O wprowadzane do obrotu przez B&O PLAY A/S i zakupione od upoważnionego sprzedawcy są objęte ograniczoną gwarancją. Szczegółowe informacje dotyczącej zakresu oraz czasu trwania ograniczonej gwarancji znajdziesz się na stronie [www.bang-olufsen.com/limited-warranty](http://www.bang-olufsen.com/limited-warranty).

**PT**

Os produtos B&O comercializados pela B&O PLAY A/S e comprados a um revendedor autorizado estão abrangidos por uma garantia limitada. Para obter informações detalhadas sobre a cobertura desta garantia limitada e a sua duração visite [www.bang-olufsen.com/limited-warranty](http://www.bang-olufsen.com/limited-warranty).

**PT-BR**

Os produtos da B&O são comercializados pela B&O PLAY A/S e podem ser comprados de um revendedor autorizado e são cobertos por garantia limitada. Para obter informações detalhadas sobre a cobertura desta garantia limitada e sua duração limitada, visite [www.bang-olufsen.com/limited-warranty](http://www.bang-olufsen.com/limited-warranty).

**RU**

На продукцию B&O, включая акустические системы B&O PLAY A/S, предоставляется авторизованного предприятия розничной торговли, распространяется действие ограниченной гарантии. Для получения более подробной информации относительно покрытия данной ограниченной гарантии и ее ограничениях посетите на [www.bang-olufsen.com/limited-warranty](http://www.bang-olufsen.com/limited-warranty).

**IT** I prodotti B&O commercializzati da B&O PLAY A/S e acquistati da un rivenditore autorizzato sono coperti da garanzia limitata. Per informazioni più dettagliate relative alla copertura di questa garanzia limitata e alla sua durata, visitare il sito [www.bang-olufsen.com/limited-warranty](http://www.bang-olufsen.com/limited-warranty).

**JA** B&O PLAY A/Sが市販しているB&O製品を認定販売店から購入された場合、製品は限定保証の対象となります。製品保証（制限つき）の保証対象および保証期間についての詳細はこちらからご覧ください [www.bang-olufsen.com/limited-warranty](http://www.bang-olufsen.com/limited-warranty)。

**KO** B&O PLAY A/S가 표기되어 있고 음인 판매점에서 구매한 B&O 제품은 제한된 보증이 적용됩니다. 제품 보증 범위와 보증 기간에 대한 자세한 내용은 [www.bang-olufsen.com/limited-warranty](http://www.bang-olufsen.com/limited-warranty)를 참조하십시오.

**MA** Produk B&O yang dipasarkan oleh B&O PLAY A/S dan dibeli daripada peruncit sah adalah dilindungi oleh waranti yang terhad. Untuk butiran lanjut tentang perlindungan jaminan terhad ini dan tempoh terhadnya sila layari [www.bang-olufsen.com/limited-warranty](http://www.bang-olufsen.com/limited-warranty).

**NL** B&O-producten die op de markt worden gebracht door B&O PLAY A/S en worden gekocht bij een erkende verkoper, vallen onder de beperkte garantie. Voor meer informatie over deze beperkte garantie en de beperkte duur ervan, kunt u terecht op [www.bang-olufsen.com/limited-warranty](http://www.bang-olufsen.com/limited-warranty).

**ES**

Los productos B&O lanzados al mercados por B&O PLAY A/S como tales y adquiridos de un distribuidor autorizado están cubiertos por una garantía limitada. Si desea obtener información detallada acerca de la cobertura que proporciona esta garantía limitada y su duración, también limitada, visite [www.bang-olufsen.com/limited-warranty](http://www.bang-olufsen.com/limited-warranty).

**FI**

B&O PLAY A/S -yhtiön markkinoimat ja valtuutetulta jälleenmyyjältä ostetut tuotteet ovat rajoitetun takuun kattamia. Lisätietoja rajoitetun takuun soveltamisalasta ja rajoitetusta kestoista on osoitteessa [www.bang-olufsen.com/limited-warranty](http://www.bang-olufsen.com/limited-warranty).

**FR**

Les produits B&O commercialisés par B&O PLAY A/S et achetés auprès d'un revendeur agréé sont couverts par une garantie limitée. Pour de plus amples informations sur la couverture qu'apporte cette garantie limitée et sur sa durée, rendez-vous à l'adresse [www.bang-olufsen.com/limited-warranty](http://www.bang-olufsen.com/limited-warranty).

**HE**

המוצרים B&O המיוצרים על ידי חברת B&O PLAY נמכרים בארץ ישראל על ידי סוכני מכירה מורשים. המוצרים מוגנים על ידי אחריות מוגבלת. לפרטים נוספים על אחריות זו, אנא פנו אל [www.bang-olufsen.com/limited-warranty](http://www.bang-olufsen.com/limited-warranty).

**HU**

A B&O PLAY A/S által hirdetett és hivatalos viszonteladótól megvásárolt B&O termékekre korlátozott garancia érvényes. Ezen korlátozott jótállás részleteit és időtartamát lásd a következő weboldalon: [www.bang-olufsen.com/limited-warranty](http://www.bang-olufsen.com/limited-warranty).

المنتجات B&O التي تم إنتاجها في جمهورية الصين الشعبية، يرجى الرجوع إلى دليل  
منتجات B&O على الإنترنت [www.bang-olufsen.com/limited-warranty](http://www.bang-olufsen.com/limited-warranty) للحصول على المزيد من المعلومات. يرجى الرجوع إلى دليل  
منتجات B&O على الإنترنت [www.bang-olufsen.com/limited-warranty](http://www.bang-olufsen.com/limited-warranty) للحصول على المزيد من المعلومات.

B&O-produkter, der markedsføres af B&O PLAY A/S og købes hos en  
autoriseret forhandler, er dækket af en begrænset garanti. Detaljerede  
oplysninger om denne begrænsede garanti og garantiens varighed findes  
på [www.bang-olufsen.com/limited-warranty](http://www.bang-olufsen.com/limited-warranty).

Für B&O Produkte, die von B&O PLAY A/S vertrieben und von einem  
autorisierten Händler erworben wurden, gilt die beschränkte Garantie.  
Weitere Informationen zu den Garantiebestimmungen finden Sie unter  
[www.bang-olufsen.com/limited-warranty](http://www.bang-olufsen.com/limited-warranty).

τα προϊόντα B&O που πωλούνται από την B&O PLAY A/S και τα οποία  
έχουν αγοράστεί από εξουσιοδοτημένο κατάστημα λιανικής καλύπτονται από  
περιορισμένη εγγύηση. Για λεπτομέρειες πληροφοριών και την περιορισμένη διάρκεια  
της εμπορεύσιμης εγγύησης [www.bang-olufsen.com/limited-warranty](http://www.bang-olufsen.com/limited-warranty).

B&O products marketed by B&O PLAY A/S and purchased from an  
authorised retailer are covered by limited warranty. For detailed  
information on the coverage of this limited warranty and its limited  
duration go to [www.bang-olufsen.com/limited-warranty](http://www.bang-olufsen.com/limited-warranty).



ضمان محدود

Begrænset Garanti

Beschränkte Garantie

Limited Warranty

Περιορισμένη Εγγύηση

Garantia Limitada

Rajoitettu Takuu

Garantie Limitée

гарантия ограни-  
ченна

Korhätösoitt Jotállás

Garanzia Limitata

製品保証 (制限つき)

제한 보증

Jamian Terhad

Bepaalde Garantie

Ograniczona Gwarancja

Garantia Limitada

Garantia Limitada

Ограниченна Гарантия

Begränset Garanti

гарантия ограни-  
ченна

Sınırlı Garanti

有限保修

有限保固

**Mexico**  
La operación de este equipo está sujeta a las siguientes dos condiciones: (1) es posible que este equipo o dispositivo no cause interferencia perjudicial y (2) este equipo o dispositivo debe aceptar cualquier interferencia, incluyendo la que pueda causar su operación no deseada.

限用物質含有情況標示聲明書  
Declaration of the Presence Condition of the Restricted  
Substances Marking

設備名稱：無線音箱  
Equipment name  
型號 (型式)：Beosound Balance  
Type designation (Type)

單元 Unit	Restricted substances and its chemical symbols					
	鉛 Lead (Pb)	汞 Mercury (Hg)	鎘 Cadmium (Cd)	六價鉻 Hexavalent chromium (Cr <sup>6+</sup> )	多溴聯苯 Polybrominated biphenyls (PBB)	多溴二苯醚 Polybrominated diphenyl ethers (PBDE)

電路板	—	○	○	○	○	○
內線材	○	○	○	○	○	○
附件	○	○	○	○	○	○
喇叭	○	○	○	○	○	○
上框體	—	○	○	○	○	○
木底框	○	○	○	○	○	○
橡膠腳墊	○	○	○	○	○	○

備考1: "超出0.1 wt %"及"超出0.01 wt %"係指限用物質之百分比含量超出百分比含量基準值。  
Note 1: "Exceeding 0.1 wt %" and "exceeding 0.01 wt %" indicate that the percentage content of the restricted substance exceeds the reference percentage value of presence condition.

備考2: "○"係指該項限用物質之百分比含量未超出百分比含量基準值。  
Note 2: "○" indicates that the percentage content of the restricted substance does not exceed the percentage of reference value of presence.

備考3: "—"係指該項限用物質為排除項目。  
Note 3: The "—" indicates that the restricted substance corresponds to the exemption.

以下規範供臺灣市場使用...

額定值	100-240VAC 50/60Hz 100W
區域網路	10/100 Mbps
無線技術	WLAN IEEE 802.11 a/b/g/n/ac, 2.4GHz and 5GHz Bluetooth, BT LE, BT classic

低功率副波輻射性電機管理辦法

#### 第十二條

經型式認證合格之低功率射頻電機，非經許可，公司、商號或使用者均不得擅自變更頻率、加大功率或變更原設計之特性及功能。

#### 第十四條

低功率射頻電機之使用不得影響飛航安全及干擾合法通信；經發現有干擾現象時，應立即停用，並改善至無干擾時方得繼續使用。

前項合法通信，指依電信規定作業之無線電通信。低功率射頻電機須認領合法通信或工業、科學及醫療用電波輻射性電機設備之干擾。

在5.25-5.35赫茲頻帶內操作之無線資訊傳輸設備，限於室內使用。

## 重要安全说明

- 请阅读这些说明。
- 请保留这些说明。
- 请注意所有警告。
- 请遵守所有说明。
- 请勿在近水处使用该设备。
- 只能使用干布清洁。
- 请勿堵塞任何通风孔。请根据制造商的说明进行安装。
- 请勿安装在散热器、热风调节器、火炉或其他发热设备（包括放大器）等热源附近。
- 保护电源线不被踩踏或挤压，特别是在插头、电源插座和电源线从设备延伸出来的位置。
- 仅使用制造商指定的配件。
- 仅使用制造商指定的或随设备销售的推车、支架、三脚架、托架或合架。如果使用制推车，请在移动推车/设备组合时务必小心，以免由于翻倒而造成伤害。
- 在雷天气或长时间不使用时，应拔出此设备的插头。
- 有关维修事宜应委托给有资质的维修服务人员。当设备遭到损坏（如电源线或插头损坏、液体进入或物体掉入设备、设备被雨淋湿或受潮、无法正常操作或者跌落）时，必须进行维修。
- 最大环境温度不应超过40°C。
- 警告：电源插头或设备组合器作为断接装置，应保持随时可用。
- 应注意不要让异物或液体进入设备内部。
- 本设备上不得放置诸如花瓶一类装有液体的物品。



产品中有毒物质的名称及含量

有毒物质		铅 (Pb)	汞 (Hg)	镉 (Cd)	六价铬 (Cr(VI))	多溴联苯 (PBB)	多溴二苯醚 (PBDE)
部件名称	X	o	o	o	o	o	o
电路板	X	o	o	o	o	o	o
内线材	o	o	o	o	o	o	o
附件	o	o	o	o	o	o	o
喇叭	o	o	o	o	o	o	o
上箱体	X	o	o	o	o	o	o
木底座	o	o	o	o	o	o	o
橡胶脚垫	o	o	o	o	o	o	o

本表格依据SJ/T 11364 的规定编制。

- o 表示该有毒物质在该部件所有均质材料中的含量均在 GB/T 26572 规定的限量要求以下。
- X 表示该有毒物质至少在该部件的某一均质材料中的含量超出 GB/T 26572 规定的限量要求。

Para evitar ferimentos, o equipamento deve ser fixado com firmeza no chão/parede de acordo com as instruções de instalação.

#### **Aviso**

- O produto destina-se apenas para uso em espaços interiores, ambientes residenciais. Utilize num intervalo de temperatura entre 10 e 40°C (50-105°F).
- Deixe espaço suficiente em torno do produto para possibilitar uma ventilação adequada.
- Não ligue qualquer um dos produtos incluídos no seu sistema à tomada elétrica antes de ligar todos os cabos.
- Não tente abrir o produto. Essas operações devem ser efetuadas por pessoal de assistência técnica qualificado.
- O produto só pode ser desligado completamente retirando a ficha da tomada de parede.
- A ficha e o cabo de alimentação fornecidos foram concebidos especificamente para o produto. Não substitua a ficha e, se o cabo de alimentação ficar danificado, deve comprar um novo através do seu revendedor da Bang & Olufsen.
- AVISO: Para reduzir o risco de incêndio ou choque elétrico, não exponha o aparelho a chuva ou humidade. Não exponha o produto a pingos ou salpicos e não coloque objetos com líquidos (por exemplo, jarras) sobre o equipamento. Para desligar completamente o equipamento de CA, desligue a ficha da tomada de parede. A tomada de parede deve estar sempre facilmente acessível.

- Evite colocar o produto sob luz solar direta ou luz artificial direta (por exemplo, um holofote).
  - Certifique-se de que o produto seja instalado, posicionado e ligado em conformidade com as instruções.
  - Coloque o produto numa superfície estável ou numa base na qual pretenda colocar o produto de forma permanente. Utilize apenas bases e suportes de parede aprovados pela Bang & Olufsen! Não coloque quaisquer objetos sobre o produto.
  - Não sujeite o produto a humidade elevada, chuva ou fontes de calor.
- Importante!**

A banda 5.15 - 5.35 GHz está restrita para utilização em espaços interiores apenas nos seguintes países: AT, BE, BG, CZ, DK, EE, FR, DE, FI, SE, CH, UK, HR.

Equipamentos eletrónicos e eletrónicos, peças e pilhas/baterias assinalados com este símbolo não devem ser eliminados juntamente com resíduos domésticos normais, mas sim recolhidos e eliminados separadamente para proteger o meio ambiente.

O revendedor da Bang & Olufsen fornecer-lhe-á informações sobre a forma correta de eliminar esses resíduos no seu país.







Pelo presente, a Bang & Olufsen A/S declara que o tipo equipamento de rádio Beosound Balance está em conformidade com a Diretiva 2014/53/UE. A Declaração de Conformidade total pode ser encontrada no site Web seguinte: <https://www.bang-olufsen.com/support/beosound-balance>

Em conformidade com 2014/53/UE, Diretiva relativa aos equipamentos de rádio (RED)  
De acordo com o Artigo 10.8(a) e 10.8(b) da RED, a tabela seguinte fornece informações sobre bandas de frequência utilizadas e a potência de transmissão RF máxima do produto para venda na UE:

Intervalo de frequência (MHz)	Potência máx. de transmissão (dBm)
5150-5725 MHz	≤20 dBm
2412-2472 MHz	≤20 dBm
2402-2480MHz	≤20 dBm

O firmware do produto está disponível para transferir a partir da Bang & Olufsen App.  
O produto vai ser vendido em todos os membros da União Europeia e países EFTA.

**AVVERTENZA**

Per prevenire lesioni personali, il presente apparato deve essere fissato in sicurezza sul pavimento o sulla parete osservando le istruzioni di installazione.

- Il prodotto è inteso solo per un uso in ambienti domestici e privi di umidità. Utilizzare a temperature comprese tra 10° e 40° C.
- Lasciare spazio sufficiente intorno al prodotto per consentire una ventilazione adeguata.
- Non collegare nessuno dei singoli dispositivi dell'impianto alla rete di alimentazione prima di aver collegato tutti i cavi.
- Non tentare di aprire il prodotto. Queste operazioni sono esclusivamente di competenza del personale tecnico qualificato.
- Il prodotto può essere spento completamente solo scollegandolo dalla presa a muro.
- Il cavo dell'alimentazione e la relativa spina in dotazione sono stati progettati specificamente per il prodotto. Non sostituire la spina e, se il cavo dovesse subire danni, è necessario acquistarne uno nuovo da un rivenditore Bang & Olufsen.
- **ATTENZIONE:** per evitare il rischio di incendi o scariche elettriche, non esporre questo apparecchio a pioggia o umidità. Non esporre l'apparecchio a gocciolii o spruzzi e non collocare oggetti contenenti liquidi, ad esempio vasi, sopra di esso. Per scollegare il completamente l'apparecchio dall'alimentazione CA, scollegare il cavo dell'alimentazione dalla presa a muro. Il dispositivo scollegato rimarrà pronto per l'uso.

La banda 5,15-5,35 GHz è limitata all'utilizzo esclusivo in interni nei seguenti Paesi: AT, BE, BG, CZ, DK, EE, FR, DE, IS, IE, IT, EL, ES, CY, LV, LI, LT, LU, HU, MT, NL, NO, PL, PT, RO, SI, SK, TR, FI, SE, CH, UK, HR.

Apparecchiature elettriche ed elettroniche, parti e batterie, contrassegnate con questo simbolo non devono essere smaltite con i normali rifiuti domestici, ma devono essere raccolte e smaltite separatamente per proteggere l'ambiente.

Per informazioni sulla procedura di smaltimento corretta per il proprio Paese, rivolgersi a un rivenditore Bang & Olufsen.



### **Importante!**

- Non esporre il prodotto alla luce del sole o artificiale (ad esempio un farfetto) diretta.
- Verificare che il prodotto sia stato installato, posizionato e collegato in conformità con le istruzioni fornite.
- Posizionare il prodotto su una superficie stabile o altra collocazione permanente. Utilizzare solo stand e staffe da parete approvati da Bang & Olufsen.
- Non posare oggetti sopra il prodotto.
- Non esporre il prodotto a valori elevati di umidità, a pioggia o a fonti di calore.



Con la presente Bang & Olufsen A/S dichiara che l'apparecchiatura radio di tipo Beosound Balance è conforme alla Direttiva 2014/53/UE. Il testo completo della Dichiarazione di conformità è reperibile al seguente sito web: <https://www.bang-olufsen.com/support/beosound-balance>

Conformità con la Direttiva 2014/53/UE (RED)  
Ai sensi degli articoli 10.8(a) e 10.8(b) della Direttiva RED, la seguente tabella fornisce informazioni sulle bande di frequenza utilizzate e sulla potenza massima di trasmissione in radiofrequenza dei prodotti in vendita nell'UE:

Gamma di frequenza (MHz)	Potenza massima di trasmissione (dBm)
2402-2480MHz	≤20 dBm
2412-2472 MHz	≤20 dBm
5150-5725 MHz	≤20 dBm

Il firmware del prodotto è scaricabile dall'app Bang & Olufsen.  
Il presente prodotto viene venduto in tutti i Paesi membri dell'Unione Europea e AELS.

Para evitar lesiones, este aparato debe estar firmemente sujeto al suelo o a la pared de acuerdo con las instrucciones de instalación.

### **ADVERTENCIA**

- Mantenga el espacio necesario alrededor del equipo para favorecer su correcta ventilación.
- No conecte ninguno de los equipos del sistema a la red eléctrica hasta que haya conectado todos los cables.
- No intente abrir el equipo. Este tipo de operaciones debe ser realizado por personal técnico cualificado.
- El equipo sólo se puede apagar totalmente desconectando el enchufe de la toma de suministro eléctrico.
- El enchufe y el cable de alimentación suministrados han sido diseñados especialmente para este equipo. No cambie el enchufe; si el cable de alimentación resulta dañado, deberá adquirir otro a través de su distribuidor de Bang & Olufsen.
- **ADVERTENCIA:** A fin de reducir el riesgo de incendio o descarga eléctrica, no exponga este aparato a la lluvia ni a la humedad. No exponga este equipo a goteos o salpicaduras ni coloque ningún objeto que contenga líquido, como un jarrón, sobre el mismo. Para desconectar completamente este equipo de la red eléctrica de corriente alterna, desconecte el enchufe de alimentación de la toma de suministro eléctrico. El dispositivo de desconexión debe encontrarse en un lugar fácilmente accesible.

La banda de 5,15-5,35 GHz está restringida solo al uso en interiores en los países siguientes: AT, BE, BG, CZ, DK, EE, FR, DE, IS, IE, IT, EL, ES, CY, LV, LI, LT, LU, HU, MT, NL, NO, PL, PT, RO, SI, SK, TR, FI, SE, CH, UK, HR.



Los equipos, piezas y baterías de tipo eléctrico y electrónico marcados con este símbolo no deben eliminarse junto con los residuos domésticos habituales; en su lugar, deben ser recogidos y eliminados de forma independiente para proteger el medioambiente.

Su distribuidor de Bang & Olufsen le asesorará acerca de los pasos a seguir en su país para realizar la eliminación de forma correcta.

### **Importante**

- Evite colocar el equipo en un lugar expuesto a la luz solar directa o a luz artificial directa, como la generada por un foco halógeno.
- Asegúrese de que el equipo permanezca instalado, situado y conectado de acuerdo con las instrucciones.
- Coloque el equipo sobre una superficie firme o en un soporte apto para su instalación permanente. Use exclusivamente soportes de pie y de pared homologados por Bang & Olufsen.
- No coloque ningún objeto sobre el equipo.
- No someta el equipo a niveles elevados de humedad, a la lluvia o a fuentes de calor.
- Este equipo ha sido diseñado exclusivamente para el uso interior en entornos domésticos secos. El uso debe tener lugar a una temperatura comprendida entre 10 y 40 °C (50 y 105 °F).



Por la presente, Bang & Olufsen A/S declara que el tipo de equipo de radio Beosound Balance cumple la directiva 2014/53/EU. Se puede consultar la declaración de conformidad completa en el sitio web siguiente: <https://www.bang-olufsen.com/support/beosound-balance>

Conformidad con la directiva 2014/53/EU sobre la comercialización de equipos radioeléctricos (RED)  
Conforme a los artículos 10.8(a) y 10.8(b) de la RED, la tabla siguiente proporciona información sobre las bandas de frecuencias utilizadas y la potencia de RF transmitida máxima del producto a la venta en la UE.

Intervalo de frecuencias (MHz)	Potencia transmitida máxima (dBm)
2402-2480MHz	≤20 dBm
2412-2472 MHz	≤20 dBm
5150-5725 MHz	≤20 dBm

El firmware del producto está disponible para descargar desde la Bang & Olufsen App.  
El producto a la venta en todos los países miembros de la Unión Europea y de la EFTA.

Pour éviter toute blessure, cet appareil doit être soigneusement fixé au sol/mur conformément aux instructions d'installation.

### **AVERTISSEMENT**

- Cet appareil est uniquement conçu pour être utilisé à l'intérieur, dans un lieu sec. Plage de températures acceptable : 10 à 40 °C. Laisser suffisamment d'espace autour de l'appareil pour une ventilation appropriée.
- Ne relier aucun élément de l'installation au secteur avant d'avoir branché tous les câbles.
- Ne pas tenter d'ouvrir le boîtier de l'appareil. Les opérations de ce type doivent être confiées à du personnel de maintenance qualifié.
- Pour éteindre complètement l'appareil, la seule possibilité est de débrancher la prise murale.
- Le câble secteur et la fiche fournis sont spécialement conçus pour cet appareil. Ne pas changer la fiche. Si le câble secteur est endommagé, en acheter un autre auprès de votre revendeur Bang & Olufsen.
- **AVERTISSEMENT** : afin de réduire le risque d'incendie ou d'électrocution, ne pas exposer cet appareil à la pluie ou à l'humidité. Ne pas exposer l'appareil à l'écoulement de liquides et aux éclaboussures et s'assurer qu'aucun objet rempli de liquide, par exemple un vase, n'est placé sur l'appareil. Pour déconnecter complètement l'appareil du secteur, débrancher le cordon d'alimentation de la prise secteur. L'appareil débranché reste prêt à l'emploi.



La bande 5,15-5,35 GHz est limitée aux opérations intérieures dans les pays suivants seulement : AT, BE, BG, CZ, DK, EE, FR, DE, IS, IE, IT, EL, ES, CY, LV, LI, LT, LU, HU, MT, NL, NO, PL, PT, RO, SI, SK, TR, FI, SE, CH, UK, HR.

*Français*



Il n'est pas permis de jeter les équipements, les pièces électriques et électroniques et les batteries portant ce symbole avec les ordures ménagères ; ces équipements doivent être collectés et mis au rebut séparément afin de préserver l'environnement.

Votre revendeur Bang & Olufsen se fera un plaisir de vous conseiller sur la procédure correcte de mise au rebut dans votre pays.

### **Important !**

- Éviter d'exposer directement l'appareil au soleil ou à la lumière artificielle (spots, etc.).
- Vérifier que l'appareil est installé, positionné et connecté conformément aux instructions.
- Poser l'appareil sur une surface ferme, de préférence sur une table, un buffet ou un pied, où il restera en permanence.
- N'utiliser que les pieds et les supports muraux agréés par Bang & Olufsen !
- Ne poser aucun objet sur l'appareil.
- Ne pas exposer l'appareil à un taux d'humidité élevé, à la pluie ou à une source de chaleur.



Par la présente, Bang & Olufsen A/S déclare que l'équipement radio de type Beosound Balance est conforme à la directive 2014/53/EU. La Déclaration de conformité complète se trouve sur le site Web suivant : <https://www.bang-olufsen.com/support/beosound-balance>

Conformité à la directive sur les équipements radio 2014/53/EU (RED) conformément à l'article 10.8(a) et 10.8(b) de RED, le tableau suivant fournit des informations sur les bandes de fréquences utilisées et la puissance de transmission RF maximale du produit à vendre dans l'UE :

Gamme de fréquences (MHz)	Puissance de transmission max. (dBm)
2402-2480MHz	≤20 dBm
2412-2472 MHz	≤20 dBm
5150-5725 MHz	≤20 dBm

Le firmware du produit est disponible pour téléchargement à partir de Bang & Olufsen App.  
Le produit à vendre dans tous les pays membres de l'Union européenne et de l'AELE.

Um Verletzungen zu vermeiden, muss dieses Gerät gemäß den Installationsanweisungen sicher am Boden / an der Wand befestigt werden.

### **WARNUNG**

- Das Gerät ist ausschließlich für den Gebrauch in trockenen Wohnräumen vorgesehen. Die zulässige Umgebungstemperatur im Betrieb beträgt zwischen 10 und 40 °C.
- Lassen Sie um das Gerät stets genug Platz für ausreichende Lüftung.
- Schließen Sie keines der Geräte in Ihrem System an das Netz an, bevor Sie alle anderen Kabel angeschlossen haben.
- Versuchen Sie nicht, das Gerät zu öffnen. Überlassen Sie dies qualifiziertem Servicepersonal.
- Das Gerät kann nur durch Netztrennung vollständig ausgeschaltet werden.
- Das mitgelieferte Netzkabel samt Stecker wurde speziell für dieses Produkt entwickelt. Tauschen Sie den Stecker nicht aus. Wenn das Netzkabel beschädigt wird, müssen Sie bei Ihrem Bang & Olufsen Fachhändler ein neues anfordern.
- ACHTUNG: Um Feuer oder elektrische Schläge zu vermeiden, darf dieses Gerät weder Regen noch Feuchtigkeit ausgesetzt werden. Setzen Sie dieses Gerät keinem Tropf- bzw. Spritzwasser aus und stellen Sie keine mit Flüssigkeiten gefüllten Objekte wie z. B. Vasen darauf ab. Um das Gerät vollständig vom Netz zu trennen, ziehen Sie den Netzstecker aus der Steckdose. Die Steckdose sollte frei zugänglich bleiben.

Das Frequenzband von 5,15-5,35 GHz ist in den folgenden Ländern auf  
Innenräume beschränkt: AT, BE, BG, CZ, DK, EE, FR, DE, IS, IE, IT, EL,  
ES, CY, LV, LI, LT, LU, HU, MT, NL, NO, PL, PT, RO, SI, SK, TR, FI, SE, CH, UK,  
HR.

*Deutsch (German)* Mit diesem Symbol gekennzeichnete elektrische und  
elektronische Geräte, Bauteile und Batterien dürfen  
nicht in den normalen Haushaltsmüll gegeben, sondern  
müssen zum Schutz der Umwelt sämtlich getrennt  
eingesammelt und entsorgt werden.

Ihr Bang & Olufsen Fachhändler berät Sie bei der  
sachgerechten Entsorgung in Ihrem Land.



### **Wichtiger Hinweis:**

- Stellen Sie das Gerät nicht in direktem Sonnenlicht oder nahe an direkten künstlichen Lichtquellen wie Spots auf.
- Achten Sie darauf, dass das Gerät entsprechend diesen Hinweisen platziert, angeschlossen und eingestellt wird.
- Stellen Sie das Gerät auf einer festen Oberfläche oder einem soliden Standfuß an dem Ort auf, wo es auf Dauer verbleiben soll. Benutzen Sie nur von Bang & Olufsen zugelassene Standfüße und Wandhalterungen!
- Stellen Sie keine Gegenstände auf das Gerät.
- Setzen Sie das Gerät nicht hoher Feuchtigkeit, Regen und Wärmequellen aus.



Hiermit erklärt Bang & Olufsen A/S, dass das Radiogerät vom Typ Beosound Balance die Richtlinie 2014/53/EU erfüllt. Die vollständige Konformitätserklärung ist auf der folgenden Website erhältlich: <https://www.bang-olufsen.com/support/beosound-balance>

Erfüllt die Funkgeräte-Richtlinie 2014/53/EU (RED) in Übereinstimmung mit Artikel 10.8(a) und 10.8(b) der RED bietet die folgende Tabelle Informationen zu den verwendeten Frequenzbändern und zur maximalen Funkfrequenz-Sendeleistung des Produkts, das in der EU vertrieben wird:

Frequenzbereich (MHz)	Max. Sendeleistung (dBm)
2402-2480MHz	≤20 dBm
2412-2472 MHz	≤20 dBm
5150-5725 MHz	≤20 dBm

Die Produkt-Firmware steht über die Bang & Olufsen App zum Download bereit.

Das Produkt wird in allen Mitgliedsstaaten der Europäischen Union und in den EFTA-Staaten vertrieben.

For at forhindre personskade skal dette apparat fastgøres sikkert til gulvet/væggen i overensstemmelse med installationsvejledningen.

### ADVARSEL

- Produktet kan kun slukkes helt ved at tage stikket ud af stikkontakten. Den medfølgende netledning og stikket på den er specielt designet til dette produkt. Stikket må ikke ændres, og hvis netledningen bliver beskadiget, skal du købe en ny hos din Bang & Olufsen forhandler.
- ADVARSEL: For at reducere risikoen for brand og elektrisk stød må dette produkt ikke udsættes for regn eller fugt. Produktet må heller ikke udsættes for dryp eller stænk, og der må ikke placeres genstande fyldt med væske, f.eks. vaser, på udstyret. Tag stikket ud af stikkontakten for helt vaser, på udstyret. Tag stikket ud af stikkontakten for helt være nemt at komme til.

Dansk (Danish)



Elektrisk og elektronisk udstyr, reservedele og batterier, der er mærket med dette symbol, må ikke bortskaffes sammen med almindeligt husholdningsaffald. Det skal indsamles og bortskaffes separat for at beskytte miljøet. Din Bang & Olufsen forhandler kan rådgive dig om den korrekte bortskaffelsesmetode i dit land.

## Vigtigt!

- Anbring ikke produktet i direkte sollys eller direkte under kunstig belysning, f.eks. en spot.
- Sørg for, at produktet sættes op, placeres og tilsluttes i overensstemmelse med instruktionerne.
- Placer produktet på en solid overflade eller stand, hvor du ønsker, det skal blive stående. Brug kun stånde og vægbeslag, der er godkendt af Bang & Olufsen.
- Anbring ikke genstande oven på produktet.
- Udsæt ikke produktet for høj luftfugtighed, regn eller varme. Produktet er udelukkende beregnet til indendørsanvendelse under tørre forhold inden for et temperaturremåde på 10-40 °C.
- Sørg for, at der er plads nok omkring produktet til at sikre tilstrækkelig ventilation.
- Slut ikke nogen af produkterne i dit system til lysnettet, før du har tilslutet alle kablerne.
- Forsøg aldrig at åbne produktet. Produktet må kun åbnes af uddannede serviceteknikere.



Bang & Olufsen A/S erklærer herved, at radioudstyret  
type Beosound Balance er i overensstemmelse med  
direktiv 2014/53/EU. Den fuldstændige  
overensstemmelseserklæring fremgår af følgende side:  
[https://www.bang-olufsen.com/support/beosound-  
balance](https://www.bang-olufsen.com/support/beosound-<br/>balance)

I overensstemmelse med radioudstyrsdirektivet 2014/53/EU (RED)  
- I overensstemmelse med paragraf 10.8(a) og 10.8(b) tilhørende RED -  
følgende tabel indeholder oplysninger om de benyttede frekvensområder  
og den maksimale RF-sendeeffekt for produktet, når det sælges i EU:

Frekvensområde (MHz)	Maks. sendeeffekt (dBm)
2.402-2.480MHz	≤20 dBm
2.412-2.472 MHz	≤20 dBm
5.150-5.725 MHz	≤20 dBm

Produktets firmware er tilgængeligt til download fra appen Bang & Olufsen.  
Produktet markedsføres til salg i alle EU-medlemsstater og EFTA-lande.

Båndet 5,15-5,35 GHz er begrænset til indendørsbrug i følgende lande:  
AT, BE, BG, CZ, DK, EE, FR, DE, IS, IE, IT, EL, ES, CY, LV, LI, LT, LU, HU, MT,  
NL, NO, PL, PT, RO, SI, SK, TR, FI, SE, CH, UK, HR.





## **RSS-102 statement**

- English:  
This equipment complies with Industry Canada radiation exposure limits set forth for an uncontrolled environment.
- French:  
Cet équipement est conforme à l'exposition aux rayonnements Industry Canada établis pour un environnement non contrôlé.

Model: Beosound Balance

Product Name: Wireless Speaker

Bang & Olufsen A/S

Phone number: +45 96841122

[www.bang-olufsen.com](http://www.bang-olufsen.com)

Japan

この製品は屋内におくのみ使用可能です

North America

5.15~5.25 GHz band

operations in the 5.15~5.25 GHz band are restricted to indoor uses only.



This equipment is a Class II or double insulated electrical appliance. It has been designed in such a way that it does not require a safety connection to electrical earth.

## **WARNING**

To prevent injury, this apparatus must be securely attached to the floor/wall in accordance with the installation instructions.

- Increase the separation between the equipment and receiver.
  - Connect the equipment into an outlet on a circuit different from that to which the receiver is connected.
  - Consult the dealer or an experienced radio/TV technician for help.
- FCC RADIATION EXPOSURE STATEMENT**
- This device complies with FCC radiation exposure limits set forth for an uncontrolled environment. This device should be installed and operated with minimum distance 20cm between the radiator & your body.
- CAN ICES-3 (B)/NMB-3(B)**  
**IC warning**
- English:  
This device contains licence-exempt transmitter(s)/receiver(s) that comply with Innovation, Science and Economic Development Canada's licence-exempt RSS(s). Operation is subject to the following two conditions:  
a) this device may not cause interference, and  
b) this device must accept any interference, including interference that may cause undesired operation of the device.
  - French:  
Cet appareil contient des émetteurs / récepteurs exempts de licence conformes aux RSS (RSS) d'Innovation, Sciences et Développement économique Canada. L'exploitation est autorisée aux deux conditions suivantes :  
a) l'appareil ne doit pas produire de brouillage, et  
b) l'utilisateur de l'appareil doit accepter tout brouillage radioélectrique subi, même si le brouillage est susceptible d'en compromettre le fonctionnement."

completely disconnect this equipment from the AC Mains.  
disconnect the mains plug from the wall socket. The wall socket must always be easily accessible.

### **Fcc statement**

- This device complies with Part 15 of the FCC Rules. Operation is subject to the following two conditions:
  - a) This device may not cause harmful interference, and
  - b) This device must accept any interference received, including interference that may cause undesired operation.
- Changes or modifications not expressly approved by the party responsible for compliance could void the user's authority to operate the equipment.

NOTE: This equipment has been tested and found to comply with the limits for a Class B digital device, pursuant to Part 15 of the FCC Rules. These limits are designed to provide reasonable protection against harmful interference in a residential installation.

This equipment generates uses and can radiate radio frequency energy and, if not installed and used in accordance with the instructions, may cause harmful interference to radio communications. However, there is no guarantee that interference will not occur in a particular installation. If this equipment does cause harmful interference to radio or television reception, which can be determined by turning the equipment off and on, the user is encouraged to try to correct the interference by one or more of the following measures:

- Reorient or relocate the receiving antenna.

## **Important!**

- Avoid placing the product in direct sunlight or direct artificial light, such as a spotlight.
- Make sure that the product is set up, placed and connected in accordance with the instructions.
- Place your product on a firm surface or stand where you want it placed permanently. Use Bang & Olufsen approved stands and wall brackets only!
- Do not place any items on top of your product.
- Do not subject the product to high humidity, rain or sources of heat. The product is intended for indoor use in dry, domestic environments only. Use within a temperature range of 10 – 40°C (50-105°F).
- Leave enough space around the product for adequate ventilation. Do not connect any of the products in your system to the mains until you have connected all the cables.
- Do not attempt to open the product. Leave such operations to qualified service personnel.
- The product can only be switched off completely by disconnecting it from the wall socket.
- The supplied plug and mains cord are specially designed for the product. Do not change the plug and if the mains cord is damaged, you must buy a new one from your Bang & Olufsen retailer.
- Using a very noisy AC supply may trigger false touch operation in very rare situations.
- **WARNING:** To reduce the risk of fire or electric shock, do not expose this appliance to rain or moisture. Do not expose this product to dripping or splashing and ensure that no objects filled with liquids, such as vases, are placed on the equipment. To

The product firmware is available for download from the Bang & Olufsen App.

The product to be sold in all European Union member and EFTA countries.

5.15-5.35 GHz band is restricted to indoor operations only in the following countries: AT, BE, BG, CZ, DK, EE, FR, DE, IS, IE, IT, EL, ES, CY, LV, LI, LT, LU, HU, MT, NL, NO, PL, PT, RO, SI, SK, TR, FI, SE, CH, UK, HR.

Electrical and electronic equipment, parts and batteries marked with this symbol must not be disposed of with normal household waste, it must be collected and disposed of separately to protect the environment.

Your Bang & Olufsen retailer will advise you of the correct way of disposal in your country.



Frequency range (MHz)	Max. Transmit Power (dbm)
2402-2480MHz	≤20 dbm
2412-2472 MHz	≤20 dbm
5150-5725 MHz	≤20 dbm

No naked flame sources, such as lighted candles should be placed on the product.

Follow instructions to ensure correct and safe installation and interconnection of equipment in multimedia systems.

Make sure the cable connection between the product and the router does not exit the building to avoid contact with high voltage.

To prevent electric shock hazard, do not connect to mains power supply while grille is removed.

Hereby, Bang & Olufsen A/S declares that the radio equipment type Beosound Balance is in compliance with Directive 2014/53/EU. The full Declaration of Conformity can be found at the following web site: <https://www.bang-olufsen.com/support/beosound-balance>

Compliance with 2014/53/EU Radio Equipment Directive (RED) in accordance with Article 10.8(a) and 10.8(b) of the RED, the following table provides information on the frequency bands used and the maximum RF transmit power of the product for sale in the EU:



- Unplug this apparatus during lightning storms or when unused for long periods of time.
  - Refer all servicing to qualified service personnel. Servicing is required when the apparatus has been damaged in any way, such as power-supply cord or plug is damaged, liquid has been spilled on or objects have fallen into the apparatus, the apparatus has been exposed to rain or moisture, does not operate normally, or has been dropped.
  - **WARNING:** To reduce the risk of fire or electric shock, do not expose this appliance to rain or moisture. Do not expose this equipment to dripping or splashing and ensure that no objects filled with liquids, such as vases, are placed on the equipment.
- The lightning flash with arrowhead symbol within an equilateral triangle, is intended to alert the user to the presence of uninsulated "dangerous voltage" within the product's enclosure that may be of sufficient magnitude to constitute a risk of electric shock to persons.
- The exclamation point within an equilateral triangle is intended to alert the user to the presence of important operating and maintenance (servicing) instructions in the literature accompanying the product.
- The product can only be switched off completely by disconnecting it from the mains socket. The mains socket must always be accessible.





## **Important safety instructions**

- Read these instructions.
- Keep these instructions.
- Head all warnings.
- Follow all instructions.
- Do not use this apparatus near water.
- Clean only with dry cloth.
- Do not block any ventilation openings. Install in accordance with the manufacturer's instructions.
- Do not install near any heat sources such as radiators, heat registers, stoves, or other apparatus (including amplifiers) that produce heat.
- Do not defeat the safety purpose of the polarized or grounding-type plug. A polarized plug has two blades with one wider than the other. A grounding type plug has two blades and a third grounding prong. The wide blade or the third prong are provided for your safety. If the provided plug does not fit into your outlet, consult an electrician for replacement of the obsolete outlet.
- Protect the power cord from being walked on or pinched particularly at plugs, convenience receptacles, and the point where they exit from the apparatus.
- Only use attachments/accessories specified by the manufacturer.
- Use only with the cart, stand, tripod, bracket, or table specified by the manufacturer, or sold with the apparatus. When a cart is used, use caution when moving the cart/apparatus combination to avoid injury from tip-over.



Use of the Works with Apple badge means that an accessory has been designed to work specifically with the technology identified in the badge and has been certified by the developer to meet Apple performance standards.

AirPlay works with iPhone, iPad, and iPod touch, or Mac and PC with iTunes.  
AirPlay, iPad, iPhone, iPod touch, iTunes and Mac are trademarks of Apple Inc., registered in U.S. and other countries. The trademark "iPhone" is used in Japan with a license from Airphone K.K.  
This wireless speaker supports AirPlay 2 and requires iOS 11.4 or later.

Se yderligere oplysninger på:  
Für weitere Informationen, siehe:  
Για περισσότερες πληροφορίες, δείτε:  
For additional information, see (link provides content with regulatory  
conformance guidelines):  
Si desea obtener más información, visite el sitio web:  
Lisätietoja saat seuraavista osoitteista:  
Pour plus d'informations, visitez (lien fournit du contenu aux directives  
de conformité réglementaires):  
Per ulteriori informazioni, vedere:  
詳細については、次を参照ください:  
저세한 내용은 다음을 참조하십시오.  
Voor meer informatie, zie:  
Para obter mais informações, consulte:  
Дополнительную информацию см. по адресу:  
Mer information finns på:

如需了解更多詳情,請參見:  
詳細資訊,請參閱:

<https://www.bang-olufsen.com/support>

Beosound Balance

Vigtigt

Wichtiger Hinweis

Σημαντικό

Important

Importante

Tärkeää

Important

Importante

重要

중요

Belangrijk

Importante

Внимание!

Viktigt

注意

重要事項

3511528

Version 1.1

2001