



## Product documentation

Binary input 6-gang  
Art. No. 2116REG



**ALBRECHT JUNG GMBH & CO. KG**  
Volmestraße 1  
58579 Schalksmühle  
GERMANY

Telefon: +49 2355 806-0  
Telefax: +49 2355 806-204  
kundencenter@jung.de  
www.jung.de

Issue: 18.05.2017  
TD 64451320 V02

## Table of Contents

<b>1</b>	<b>Product definition</b>	<b>3</b>
1.1	Product catalogue	3
1.2	Function	3
<b>2</b>	<b>Mounting, electrical connection and operation</b>	<b>4</b>
2.1	Safety instructions	4
2.2	Device components	5
2.3	Fitting and electrical connection	6
2.4	Commissioning	10
<b>3</b>	<b>Technical data</b>	<b>11</b>
<b>4</b>	<b>Software description</b>	<b>12</b>
4.1	Software specification	12
4.2	Software "Binary input 706611"	13
4.2.1	Scope of functions	13
4.2.2	Notes on software	15
4.2.3	Object table	16
4.2.4	Functional description	37
4.2.4.1	Application basics	37
4.2.4.2	Description of channel-independent functions	40
4.2.4.3	Channel-oriented functional description	41
4.2.4.3.1	"Switching" function	41
4.2.4.3.2	"Dimming" function	42
4.2.4.3.3	"Venetian blind" function	43
4.2.4.3.4	"Value transmitter" function	45
4.2.4.3.5	"Pulse counter" function	48
4.2.4.3.6	Disabling functions of the inputs	57
4.2.4.4	Delivery state	58
4.2.5	Parameters	59
4.2.5.1	General parameters	59
4.2.5.2	Parameter for the binary inputs	61
4.2.5.2.1	Parameters for "Switching" function	61
4.2.5.2.2	Parameters for the "Dimming" function	63
4.2.5.2.3	Parameters for the "Venetian blind" function	65
4.2.5.2.4	Parameters for the "Value transmitter" function	67
4.2.5.2.5	Parameters for the "Pulse counter" function	71
4.2.5.2.6	Parameter "Cyclical transmission"	85
4.2.5.2.7	"Disable" parameters	87
<b>5</b>	<b>Appendix</b>	<b>92</b>
5.1	Index	92

## 1 Product definition

### 1.1 Product catalogue

Product name: Binary input 6-gang  
Use: Sensor  
Design: RMD (rail-mounted device)  
Art. No. 2116REG

### 1.2 Function

The device has 6 independent inputs that electrical signals in the voltage range 10...230V can be connected to. In this way, it is possible to read states from suitable switches, push-buttons or comparable contacts and to supply them to the KNX as sensor commands.

The device also evaluates direct voltage signals (DC) as well as alternating voltage signals (AC) from external voltage sources.

Inputs 1-3 and inputs 4-6 each have a common reference potential.

The device evaluates the recorded switching edges of the voltage signals and thereby determines the states of the contacts connected. Depending on the KNX function configured in the ETS, the device converts the determined contact states into KNX telegrams. These can be, for instance, telegrams for switching, for dimming (also for one push-button dimming) or for shutter control. It is also possible to program value transmitter functions such as dimming value transmitters, light-scene extensions, temperature value transmitters or brightness value transmitters. Each device input can also function as a pulse counter. The device counts the transmitted pulses up or down.

The device is supplied solely from the bus voltage. An additional mains voltage supply is not required.

The device is designed for mounting on DIN-rails in closed compact boxes or in installation distributors. Installation only in fixed installations in dry rooms.

## 2 Mounting, electrical connection and operation

### 2.1 Safety instructions



Electrical devices may only be mounted and connected by electrically skilled persons.

Failure to observe the instructions may cause damage to the device and result in fire and other hazards.

**Danger of electric shock. When connecting SELV/PELV systems, ensure safe isolation from other voltages.**

The device may not be opened or operated outside the technical specifications.

## 2.2 Device components

The 6-way binary input is a rail-mounted device. The device is suitable for installation in a small distribution board. 2 free distribution units are needed for the installation.

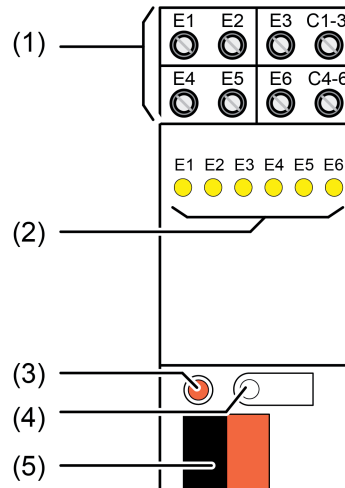

Figure 1: Device components binary input 6-gang 10...230 V

(1) Connection for inputs

E1...E6: signal inputs

**C1-3:** Common reference potential for inputs **E1...E3**

**C4-6:** Common reference potential for inputs **E4...E6**

(2) Status LED inputs, yellow

On: voltage for signal level "1" present.

Off: voltage for signal level "0" present.

(3) Programming LED, red

(4) Programming button

(5) KNX connection

## 2.3 Fitting and electrical connection

### Fitting the device



**DANGER!**

**Electrical shock when live parts are touched.**

**Electrical shocks can be fatal.**

**Before working on the device, disconnect the power supply and cover up live parts in the working environment.**

- Fit the device by snapping it onto a DIN-rail in acc. with EN 60715. The screw terminals for the inputs should be at the top.
- i** A KNX data rail is not required.
- i** Observe the temperature range and ensure sufficient cooling, if necessary.

### Connecting mains supply circuits

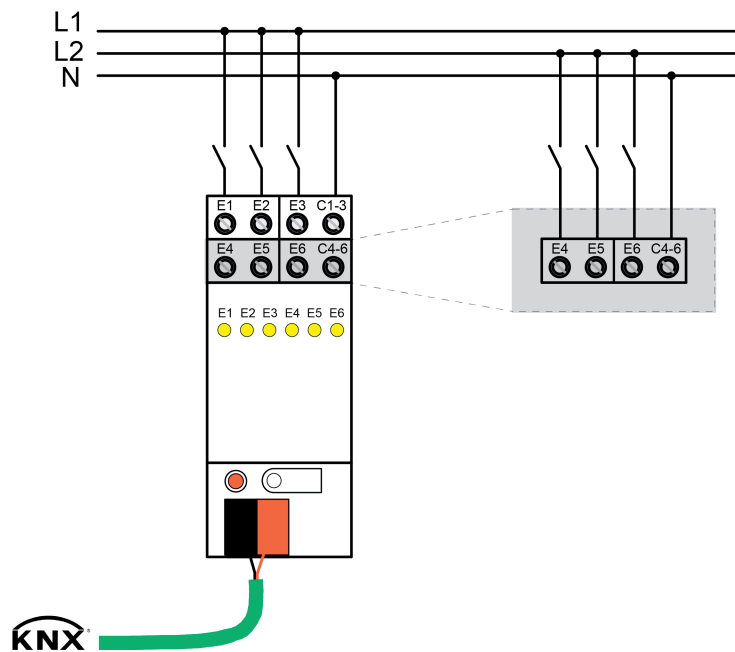

Figure 2: Connection mains supply circuits

Precondition: Mains-powered circuits are connected to the inputs.

- Connect the common reference potential **N** to the terminals **C1-3** and **C4-6**.
- i** For DC operation: observe polarity of the input voltage.
- i** Do not connect different phase conductor to each input group **E1...E3** or **E4...E6**.
- i** The input groups **E1...E3** and **E4...E6** can be connected to different RCD protection switches.

## Connecting SELV/PELV circuits

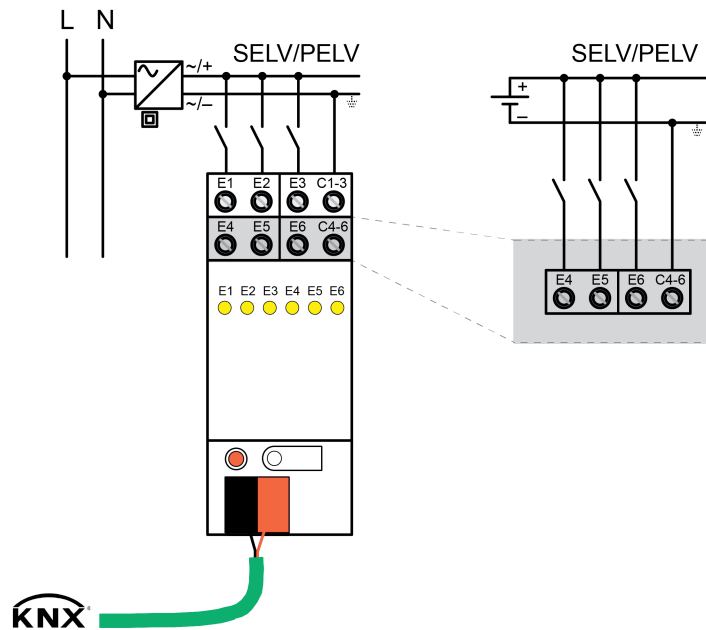

Figure 3: Connecting SELV/PELV circuits

- i** Circuits with a low-voltage supply at the inputs must possess the same protection measure. Do not connect SELV/PELV and FELV systems together to the inputs.

Precondition: Low-voltage-powered circuits (SELV/PELV) are connected to the inputs.

- Connect SELV/PELV-supplied circuits as shown in the connection example (figure 3)Connecting . Comply with the polarity.

- i** Label SELV/PELV-supplied circuits.

## Connecting FELV circuits

Precondition: Low-voltage-powered circuits (FELV) are connected to the inputs.

- Connect FELV-supplied circuits as mains-supplied circuits according to the connection example (figure 2)Connecting .

## Connecting mains and low-voltage-supplied circuits jointly

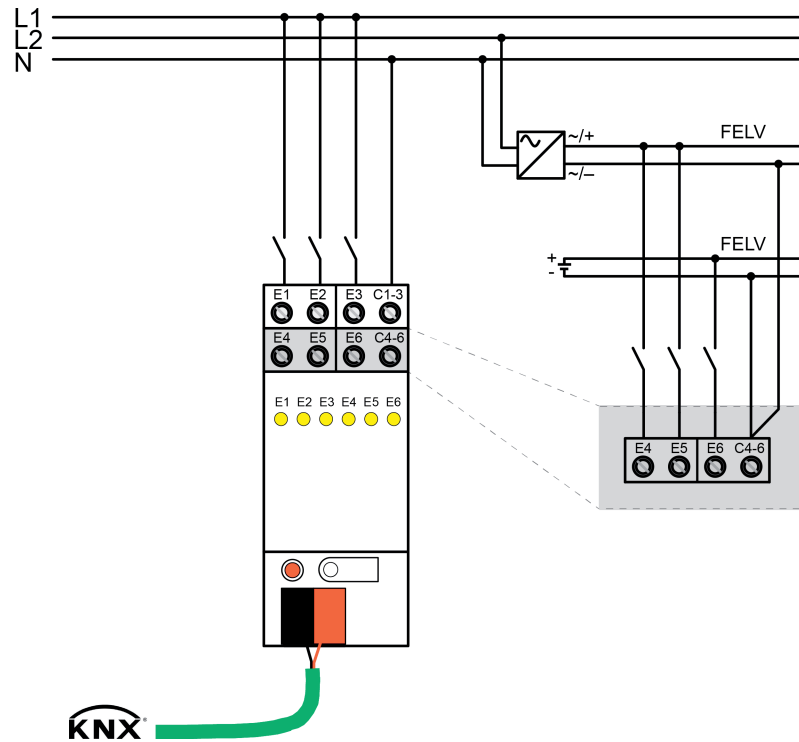

Figure 4: Joint connection of mains and low-voltage circuits

Precondition: Mains or low-voltage-powered circuits are connected to the inputs.

- Connect circuits as shown in the connection example (figure 4)Connecting .

**i** For combined operation: Observe the current values of the input voltages. Do not exceed the nominal voltage.

### Installing / removing the protective cap

To protect the bus lines against hazardous voltages in the area of the connecting terminals, a protective cap can be installed.

The cap is installed with the bus terminal in place and the connected bus line led out at the rear.

- To install the cap: slide the cap over the bus terminal until you feel it engage (figure 5).
- To remove the cap: Remove the cap by pressing the sides slightly and by pulling it out to the front (figure 5).



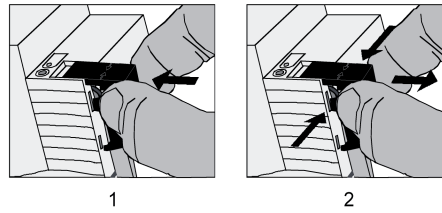

Figure 5: Installing / removing the protective cap for the bus connection

## 2.4 Commissioning

The commissioning is basically restricted to programming the physical address and the application program by using the ETS.

### Commissioning with the ETS

Project design and commissioning of the device using the ETS4.2, ETS5 or newer versions.

Precondition: The device is connected and ready for operation.

- Switch on the bus voltage.  
Check: When the programming button is pressed, the red programming LED must light up. Switching on the bus voltage causes the device carry out the "Behaviour after bus voltage return" configured in the ETS. In the state as supplied, this behaviour is set as "no reaction".
  
- Programming the physical address and the application data with the ETS.

## 3 Technical data

### General

Test mark	KNX/EIB
Ambient temperature	-5 ... +45 °C
Storage/transport temperature	-25 ... +75 °C
Relative humidity	max. 93 % (No moisture condensation)
Fitting width	36 mm / 2 modules
Fixing type	Snapping onto top hat rails in closed housing (e.g. small distribution board, etc.)
Minimum distances	none
Installation position	as desired (preferably top output terminals)

### Connection

Connection mode	Screw terminal
single stranded	0.5 ... 4 mm <sup>2</sup>
Finely stranded without conductor sleeve	0.5 ... 4 mm <sup>2</sup>
Finely stranded with conductor sleeve	0.5 ... 2.5 mm <sup>2</sup>
Connection torque	max. 0.8 Nm

### KNX supply

KNX medium	TP
Commissioning mode	S-mode
Rated voltage KNX	DC 21 ... 32 V SELV
Power consumption KNX	max. 150 mW
Current consumption KNX	max. 7.5 mA
Connection mode KNX	Standard device connection terminal

### Inputs

Rated voltage	AC/DC 10 ... 230 V
Signal level "0" signal	0 ... 2 V
Signal level "1" signal	7 ... 230 V
Input current at nominal voltage	approx. 0.7 mA
Power loss	max. 1 W
Cable length	max. 100 m
Rated frequency AC signal	30 ... 60 Hz
Signal length, pulse counter	min. 100 ms

### Number of contacts per input

NO contacts	max. 50
NC contacts	max. 50

## 4 Software description

### 4.1 Software specification

ETS search paths:                   Input / Binary Input, 6-gang / Binary input 6-gang  
Configuration:                        S-mode standard

#### Application program available:

No.	Short description	Name	Version	from mask version
1	Multifunction application for binary inputs.	Input 706611	1.1 for ETS4.2 or ETS5	705

## 4.2 Software "Binary input 706611"

### 4.2.1 Scope of functions

#### General

- 6 potential-free binary inputs to trigger telegrams for switching or dimming, Venetian blind control, transmitter application (dimmer value transmitter, light scene extension, temperature or brightness value transmitter) or pulse counting (0...255, -128...127, 0...65.535, -32.768...32.767, 0...4.294.967.295, -2.147.483.648...2.147.483.647) as up- or down-counters.
- Each input offers the full scope of functions without any restrictions. All channel-orientated functions can be configured separately for each input. This feature permits independent evaluation of the inputs.
- Actively transmitting telegrams of the inputs can be delayed globally after bus voltage return or after an ETS programming operation.
- Reaction after bus voltage return can be set for all inputs.
- Debounce time and telegram rate limit can be configured.

#### Binary inputs

- Free allocation of the functions switching, dimming, blind, value transmitter and pulse counter to the inputs.
- Disabling object for disabling individual inputs (polarity of the disabling object is adjustable) for the functions switching, dimming, Venetian blinds and value transmitter.
- Behaviour on bus voltage return can be configured separately for each input.
- Scope of detail for the "Switching" function:

Two independent switching objects available for each input (switching commands can be configured individually).  
Command can be set independently for rising and falling edge (ON, OFF, TOGGLE, no reaction).  
Independent cyclical transmission of the switching objects can be selected depending on the edge or depending on the object value.
- Scope of detail for the "Dimming" function:

Single-area and dual-area operation possible.  
Time between dimming and switching and dimming step width is adjustable.  
Telegram repetition and stop telegram transmission possible.
- Scope of detail for the "Venetian blind" function:

Command can be set independently for rising edge (no function, UP, DOWN, TOGGLE).  
Operation concept configurable (short – long – short or long – short).  
Time adjustable between short-time and long-time operation (only for short – long – short)  
Adjustable slat adjustment time (time during which a MOVE command can be terminated by releasing a push-button on the input).

- Scope of detail for the "Value transmitter" function:

Edge (push-button as NO contact, push-button as NC contact, switch) and value for edge can be configured.

Value adjustment for push-button long key-press possible for value transmitter.

For light scene extension with memory function, the scene can also be saved without prior recall.

- Scope of detail for the "Pulse counter" function:

Adjustable counting interval (0...255, -128...127, 0...65.535, -32.768...32.767, 0...4.294.967.295, 2.147.483.648...2.147.483.647).

Edge (counting at rising edge, counting at falling edge, counting at rising and falling edges) can be configured.

Number of pulses required at input per reported counting pulse can be configured on the KNX.

Number of counting pulses required to change the counter status can be configured.

Each input has a main counter and an intermediate counter.

The main and intermediate counters can be separately set as up- or down-counters.

The meter start and end values can be specified via parameter or communication object.

The meter reading can be polled or transmitted automatically via the KNX.

The behaviour after the counter has elapsed can be configured.

The pulse counter can be reset via the KNX (meter reset).

## 4.2.2 Notes on software

### ETS project design and commissioning

For project design and commissioning of the device, ETS4.2 or ETS5 is required. The necessary product database is offered in the \*.knxprod format. The corresponding application program has the version number "1.1".

### Unloading the application program

The application program can be unloaded with the ETS. The device does not then function.

- i If an application program has been unloaded, the status LEDs are switched off continuously so that they can no longer display the signal status of the inputs.

## 4.2.3 Object table

Number of communication objects:	96 (max. object number 126)
Number of addresses (max.):	254
Number of assignments (max.):	255
Dynamic table management	no

### Objects for the "Switching" function

---

Function:	Switching				
Object	Function	Name	Type	DPT	Flag
 0, 1, 2, ..., 5	Switching object X.1	Input 1...6	1-bit	1,001	C, W, T <sup>1</sup>
Description	1-bit object for transmission of switching telegrams (ON, OFF). (first switching object)				

---

Function:	Switching				
Object	Function	Name	Type	DPT	Flag
 8, 9, 10, ..., 13	Switching object X.2	Input 1...6	1-bit	1,001	C, W, T <sup>1</sup>
Description	1-bit object for transmission of switching telegrams (ON, OFF). (second switching object)				

### Objects for the "Dimming" function

---

Function:	Dimming				
Object	Function	Name	Type	DPT	Flag
 0, 1, 2, ..., 5	Switching	Input 1...6	1-bit	1,001	C, W, T <sup>1</sup>
Description	1-bit object for the transmission of switching telegrams (ON, OFF) for the dimming function.				

---

Function:	Dimming				
Object	Function	Name	Type	DPT	Flag
 8, 9, 10, ..., 13	Dimming	Input 1...6	4-bit	3,007	C, W, T <sup>1</sup>
Description	4-bit object for change of relative brightness between 0 and 100 %.				

1: For reading, the R-flag must be set. The last value written to the object via the bus or by the device will be read.



## Objects for the "Venetian blind" function

Function: Venetian blind

Object	Function	Name	Type	DPT	Flag
 0, 1, 2, ..., 5	Short time operation	Input 1...6	1-bit	1,008	C, -, T <sup>1</sup>

Description 1-bit object for short-time operation of a blind.

Function: Venetian blind

Object	Function	Name	Type	DPT	Flag
 8, 9, 10, ..., 13	Long-time operation	Input 1...6	1-bit	1,007	C, W, T <sup>1</sup>

Description 1-bit object for long-time operation of a blind.

## Objects for the "Value transmitter" function

Function: Value transmitter (dimming value transmitter)

Object	Function	Name	Type	DPT	Flag
 0, 1, 2, ..., 5	Value	Input 1...6	1 byte	5,001	C, -, T <sup>1</sup>

Description 1 byte object to transmit value telegrams (0 ... 255).

Function: Value transmitter (temperature value transmitter)

Object	Function	Name	Type	DPT	Flag
 0, 1, 2, ..., 5	Temperature value	Input 1...6	2 byte	9,001	C, -, T <sup>1</sup>

Description 2-byte object for transmission of temperature value telegrams (0 °C ... 40 °C).

Function: Value transmitter (brightness value transmitter)

Object	Function	Name	Type	DPT	Flag
 0, 1, 2, ..., 5	Brightness value	Input 1...6	2 byte	9,004	C, -, T <sup>1</sup>

Description 2-byte object for transmission of brightness value telegrams (0 Lux ... 1,500 Lux).

1: For reading, the R-flag must be set. The last value written to the object via the bus or by the device will be read.

Function: Value transmitter (light scene extension)

Object	Function	Name	Type	DPT	Flag
☐← 0, 1, 2, ..., 5	Light scene extension	Input 1...6	1 byte	18,001	C, -, T <sup>1</sup>

Description 1-byte object for opening or saving light scenes (1 ... 64).

## Objects for the "Pulse counter" function

Function: Pulse counter

Object	Function	Name	Type	DPT	Flag
☐← 0, 1, 2, ..., 5	Main counter message: counter has elapsed	Input 1...6	1-bit	1,002	C, -, T <sup>1</sup>

Description This 1-bit object reports that the main counter has elapsed to the KNX. Only visible when parameter "Report elapsed counter to KNX?" is set to "Yes".

Function: Pulse counter

Object	Function	Name	Type	DPT	Flag
☐← 8, 9, 10, ..., ..., 13	Main counter message, interval limit fault	Input 1...6	1-bit	1,002	C, -, T <sup>1</sup>

Description This 1-bit object reports a main counter interval limit fault to the KNX. An interval limit fault is transmitted when:  
 - Up-counter: Start value >= End value  
 Down-counter: Start value <= End value  
 The interval limit fault is also read out if the communication objects "start value" and "end value" have not yet received a valid value telegram via the KNX.

Function: Pulse counter

Object	Function	Name	Type	DPT	Flag
☐← 16, 17, 18, ..., 21	Main counter, polling counter status	Input 1...6	1-bit	1,017	C, W <sup>1</sup>

Description 1-bit object for polling the current main counter status. If this object is defined with a "1" telegram, the device transmits the current meter reading to the KNX. This communication object is only visible when parameter "Permit counter status polling via KNX?" is set to "Yes".

1: For reading, the R-flag must be set. The last value written to the object via the bus or by the device will be read.

Function: Pulse counter

Object	Function	Name	Type	DPT	Flag
 24, 25, 26, ..., 29	Main counter, reset meter reading	Input 1...6	1-bit	1,015	C, W <sup>1</sup>

Description: 1-bit object for resetting the current main counter status. If this object is defined with a "1" telegram, the meter reading is reset to the start value that was configured or specified via an object. This communication object is only visible when parameter "Permit counter reset via KNX?" is set to "Yes".

Function: Pulse counter

Object	Function	Name	Type	DPT	Flag
 33, 34, 35, ..., 38	Main meter reading	Input 1...6	1 byte	5,010	C, -, T <sup>1</sup>

Description: This 1-bit object automatically transmits the current main meter reading to the KNX (after changes or cyclically) when parameter "Permit automatic transmission of meter reading?" is set to "Yes". The meter reading can be read out via the KNX if the R-flag is set. The data format and data point type are set corresponding to the configured function of the pulse counter (here, pulse counter 0...255).

Function: Pulse counter

Object	Function	Name	Type	DPT	Flag
 33, 34, 35, ..., 38	Main meter reading	Input 1...6	1 byte	6,010	C, -, T <sup>1</sup>

Description: This 1-bit object automatically transmits the current main meter reading to the KNX (after changes or cyclically) when parameter "Permit automatic transmission of meter reading?" is set to "Yes". The meter reading can be read out via the KNX if the R-flag is set. The data format and data point type are set corresponding to the configured function of the pulse counter (here, pulse counter -128...127).

Function: Pulse counter

Object	Function	Name	Type	DPT	Flag
 33, 34, 35, ..., 38	Main meter reading	Input 1...6	2 byte	7,001	C, -, T <sup>1</sup>

Description: This 2-bit object automatically transmits the current main meter reading to the KNX (after changes or cyclically) when parameter "Permit automatic transmission of meter reading?" is set to "Yes". The meter reading can be read out via the KNX if the R-flag is set. The data format and data point type are set corresponding to the configured function of the pulse counter (here, pulse counter 0...65.535).

1: For reading, the R-flag must be set. The last value written to the object via the bus or by the device will be read.

Function: Pulse counter

Object	Function	Name	Type	DPT	Flag
<input type="checkbox"/> ← 33, 34, 35, ..., 38	Main meter reading	Input 1...6	2 byte	8,001	C, -, T <sup>1</sup>

Description This 1-bit object automatically transmits the current main meter reading to the KNX (after changes or cyclically) when parameter "Permit automatic transmission of meter reading?" is set to "Yes". The meter reading can be read out via the KNX if the R-flag is set. The data format and data point type are set corresponding to the configured function of the pulse counter (here, pulse counter -32.768...32.767).

Function: Pulse counter

Object	Function	Name	Type	DPT	Flag
<input type="checkbox"/> ← 33, 34, 35, ..., 38	Main meter reading	Input 1...6	4 byte	12,001	C, -, T <sup>1</sup>

Description This 1-bit object automatically transmits the current main meter reading to the KNX (after changes or cyclically) when parameter "Permit automatic transmission of meter reading?" is set to "Yes". The meter reading can be read out via the KNX if the R-flag is set. The data format and data point type are set corresponding to the configured function of the pulse counter (here, pulse counter 0...4.294.967.295).

Function: Pulse counter

Object	Function	Name	Type	DPT	Flag
<input type="checkbox"/> ← 33, 34, 35, ..., 38	Main meter reading	Input 1...6	4 byte	13,001	C, -, T <sup>1</sup>

Description This 1-bit object automatically transmits the current main meter reading to the KNX (after changes or cyclically) when parameter "Permit automatic transmission of meter reading?" is set to "Yes". The meter reading can be read out via the KNX if the R-flag is set. The data format and data point type are set corresponding to the configured function of the pulse counter (here, pulse counter -2.147.483.648...2.147.483.647).

Function: Pulse counter

Object	Function	Name	Type	DPT	Flag
<input type="checkbox"/> ← 41, 42, 43, ..., 46	Main counter start value	Input 1...6	1 byte	5,010	C, W <sup>1</sup>

Description If the main counter is working as an up-counter, the input receives the start value of the main counter via this communication object. This object is visible when parameter "Specification of start value" is set to "Via communication object". As long as no correct value telegram is received, the input transmits an interval limit fault. The data format and data point type are set corresponding to the configured function of the pulse counter (here, pulse counter 0...255).

1: For reading, the R-flag must be set. The last value written to the object via the bus or by the device will be read.

---

Function:	Pulse counter				
Object	Function	Name	Type	DPT	Flag
 41, 42, 43, ..., 46	Main counter start value	Input 1...6	1 byte	6,010	C, W <sup>1</sup>
Description	If the main counter is working as an up-counter, the input receives the start value of the main counter via this communication object. This object is visible when parameter "Specification of start value" is set to "Via communication object". As long as no correct value telegram is received, the input transmits an interval limit fault. The data format and data point type are set corresponding to the configured function of the pulse counter (here, pulse counter -128...127).				

---

Function:	Pulse counter				
Object	Function	Name	Type	DPT	Flag
 41, 42, 43, ..., 46	Main counter start value	Input 1...6	2 byte	7,001	C, W <sup>1</sup>
Description	If the main counter is working as an up-counter, the input receives the start value of the main counter via this communication object. This object is visible when parameter "Specification of start value" is set to "Via communication object". As long as no correct value telegram is received, the input transmits an interval limit fault. The data format and data point type are set corresponding to the configured function of the pulse counter (here, pulse counter 0...65.535).				

---

Function:	Pulse counter				
Object	Function	Name	Type	DPT	Flag
 41, 42, 43, ..., 46	Main counter start value	Input 1...6	2 byte	8,001	C, W <sup>1</sup>
Description	If the main counter is working as an up-counter, the input receives the start value of the main counter via this communication object. This object is visible when parameter "Specification of start value" is set to "Via communication object". As long as no correct value telegram is received, the input transmits an interval limit fault. The data format and data point type are set corresponding to the configured function of the pulse counter (here, pulse counter -32.768...32.767).				

---

Function:	Pulse counter				
Object	Function	Name	Type	DPT	Flag
 41, 42, 43, ..., 46	Main counter start value	Input 1...6	4 byte	12,001	C, W <sup>1</sup>
Description	If the main counter is working as an up-counter, the input receives the start value of the main counter via this communication object. This object is visible when parameter "Specification of start value" is set to "Via communication object". As long as no correct value telegram is received, the input transmits an interval limit fault. The data format and data point type are set corresponding to the configured function of the pulse counter (here, pulse counter 0...4.294.967.295).				

1: For reading, the R-flag must be set. The last value written to the object via the bus or by the device will be read.

---

Function:	Pulse counter				
Object	Function	Name	Type	DPT	Flag
 41, 42, 43, ..., 46	Main counter start value	Input 1...6	4 byte	13,001	C, W <sup>1</sup>
Description	If the main counter is working as an up-counter, the input receives the start value of the main counter via this communication object. This object is visible when parameter "Specification of start value" is set to "Via communication object". As long as no correct value telegram is received, the input transmits an interval limit fault. The data format and data point type are set corresponding to the configured function of the pulse counter (here, pulse counter -2.147.483.648...2.147.483.647).				

---

Function:	Pulse counter				
Object	Function	Name	Type	DPT	Flag
 49, 50, 51, ..., 54	Main counter end value	Input 1...6	1 byte	5,010	C, W <sup>1</sup>
Description	If the main counter is working as an up-counter, the input receives the end value of the main counter via this communication object. This object is visible when parameter "Specification of end value" is set to "Via communication object". As long as no correct value telegram is received, the input transmits an interval limit fault. The data format and data point type are set corresponding to the configured function of the pulse counter (here, pulse counter 0...255).				

---

Function:	Pulse counter				
Object	Function	Name	Type	DPT	Flag
 49, 50, 51, ..., 54	Main counter end value	Input 1...6	1 byte	6,010	C, W <sup>1</sup>
Description	If the main counter is working as an up-counter, the input receives the end value of the main counter via this communication object. This object is visible when parameter "Specification of end value" is set to "Via communication object". As long as no correct value telegram is received, the input transmits an interval limit fault. The data format and data point type are set corresponding to the configured function of the pulse counter (here, pulse counter -128...127).				

---

Function:	Pulse counter				
Object	Function	Name	Type	DPT	Flag
 49, 50, 51, ..., 54	Main counter end value	Input 1...6	2 byte	7,001	C, W <sup>1</sup>
Description	If the main counter is working as an up-counter, the input receives the end value of the main counter via this communication object. This object is visible when parameter "Specification of end value" is set to "Via communication object". As long as no correct value telegram is received, the input transmits an interval limit fault. The data format and data point type are set corresponding to the configured function of the pulse counter (here, pulse counter 0...65.535).				

1: For reading, the R-flag must be set. The last value written to the object via the bus or by the device will be read.

---

Function:	Pulse counter				
Object	Function	Name	Type	DPT	Flag
 49, 50, 51, ..., 54	Main counter end value	Input 1...6	2 byte	8,001	C, W <sup>1</sup>
Description	If the main counter is working as an up-counter, the input receives the end value of the main counter via this communication object. This object is visible when parameter "Specification of end value" is set to "Via communication object". As long as no correct value telegram is received, the input transmits an interval limit fault. The data format and data point type are set corresponding to the configured function of the pulse counter (here, pulse counter -32.768...32.767).				

---

Function:	Pulse counter				
Object	Function	Name	Type	DPT	Flag
 49, 50, 51, ..., 54	Main counter end value	Input 1...6	4 byte	12,001	C, W <sup>1</sup>
Description	If the main counter is working as an up-counter, the input receives the end value of the main counter via this communication object. This object is visible when parameter "Specification of end value" is set to "Via communication object". As long as no correct value telegram is received, the input transmits an interval limit fault. The data format and data point type are set corresponding to the configured function of the pulse counter (here, pulse counter 0...4.294.967.295).				

---

Function:	Pulse counter				
Object	Function	Name	Type	DPT	Flag
 49, 50, 51, ..., 54	Main counter end value	Input 1...6	4 byte	13,001	C, W <sup>1</sup>
Description	If the main counter is working as an up-counter, the input receives the end value of the main counter via this communication object. This object is visible when parameter "Specification of end value" is set to "Via communication object". As long as no correct value telegram is received, the input transmits an interval limit fault. The data format and data point type are set corresponding to the configured function of the pulse counter (here, pulse counter -2.147.483.648...2.147.483.647).				

---

Function:	Pulse counter				
Object	Function	Name	Type	DPT	Flag
 49, 50, 51, ..., 54	Main counter start value	Input 1...6	1 byte	5,010	C, W <sup>1</sup>
Description	If the main counter is working as a down-counter, the input receives the start value of the main counter via this communication object. This object is visible when parameter "Specification of start value" is set to "Via communication object". As long as no correct value telegram is received, the input transmits an interval limit fault. The data format and data point type are set corresponding to the configured function of the pulse counter (here, pulse counter 0...255).				

1: For reading, the R-flag must be set. The last value written to the object via the bus or by the device will be read.

---

Function:	Pulse counter				
Object	Function	Name	Type	DPT	Flag
 49, 50, 51, ..., 54	Main counter start value	Input 1...6	1 byte	6,010	C, W <sup>1</sup>
Description	<p>If the main counter is working as a down-counter, the input receives the start value of the main counter via this communication object. This object is visible when parameter "Specification of start value" is set to "Via communication object". As long as no correct value telegram is received, the input transmits an interval limit fault. The data format and data point type are set corresponding to the configured function of the pulse counter (here, pulse counter -128...127).</p>				

---

Function:	Pulse counter				
Object	Function	Name	Type	DPT	Flag
 49, 50, 51, ..., 54	Main counter start value	Input 1...6	2 byte	7,001	C, W <sup>1</sup>
Description	<p>If the main counter is working as a down-counter, the input receives the start value of the main counter via this communication object. This object is visible when parameter "Specification of start value" is set to "Via communication object". As long as no correct value telegram is received, the input transmits an interval limit fault. The data format and data point type are set corresponding to the configured function of the pulse counter (here, pulse counter 0...65.535).</p>				

---

Function:	Pulse counter				
Object	Function	Name	Type	DPT	Flag
 49, 50, 51, ..., 54	Main counter start value	Input 1...6	2 byte	8,001	C, W <sup>1</sup>
Description	<p>If the main counter is working as a down-counter, the input receives the start value of the main counter via this communication object. This object is visible when parameter "Specification of start value" is set to "Via communication object". As long as no correct value telegram is received, the input transmits an interval limit fault. The data format and data point type are set corresponding to the configured function of the pulse counter (here, pulse counter -32.768...32.767).</p>				

---

Function:	Pulse counter				
Object	Function	Name	Type	DPT	Flag
 49, 50, 51, ..., 54	Main counter start value	Input 1...6	4 byte	12,001	C, W <sup>1</sup>
Description	<p>If the main counter is working as a down-counter, the input receives the start value of the main counter via this communication object. This object is visible when parameter "Specification of start value" is set to "Via communication object". As long as no correct value telegram is received, the input transmits an interval limit fault. The data format and data point type are set corresponding to the configured function of the pulse counter (here, pulse counter 0...4.294.967.295).</p>				

1: For reading, the R-flag must be set. The last value written to the object via the bus or by the device will be read.



---

Function:	Pulse counter				
Object	Function	Name	Type	DPT	Flag
 49, 50, 51, ..., 54	Main counter start value	Input 1...6	4 byte	13,001	C, W <sup>1</sup>
Description	If the main counter is working as a down-counter, the input receives the start value of the main counter via this communication object. This object is visible when parameter "Specification of start value" is set to "Via communication object". As long as no correct value telegram is received, the input transmits an interval limit fault. The data format and data point type are set corresponding to the configured function of the pulse counter (here, pulse counter -2.147.483.648...2.147.483.647).				

---

Function:	Pulse counter				
Object	Function	Name	Type	DPT	Flag
 41, 42, 43, ..., 46	Main counter end value	Input 1...6	1 byte	5,010	C, W <sup>1</sup>
Description	If the main counter is working as a down-counter, the input receives the end value of the main counter via this communication object. This object is visible when parameter "Specification of end value" is set to "Via communication object". As long as no correct value telegram is received, the input transmits an interval limit fault. The data format and data point type are set corresponding to the configured function of the pulse counter (here, pulse counter 0...255).				

---

Function:	Pulse counter				
Object	Function	Name	Type	DPT	Flag
 41, 42, 43, ..., 46	Main counter end value	Input 1...6	1 byte	6,010	C, W <sup>1</sup>
Description	If the main counter is working as a down-counter, the input receives the end value of the main counter via this communication object. This object is visible when parameter "Specification of end value" is set to "Via communication object". As long as no correct value telegram is received, the input transmits an interval limit fault. The data format and data point type are set corresponding to the configured function of the pulse counter (here, pulse counter -128...127).				

---

Function:	Pulse counter				
Object	Function	Name	Type	DPT	Flag
 41, 42, 43, ..., 46	Main counter end value	Input 1...6	2 byte	7,001	C, W <sup>1</sup>
Description	If the main counter is working as a down-counter, the input receives the end value of the main counter via this communication object. This object is visible when parameter "Specification of end value" is set to "Via communication object". As long as no correct value telegram is received, the input transmits an interval limit fault. The data format and data point type are set corresponding to the configured function of the pulse counter (here, pulse counter 0...65.535).				

1: For reading, the R-flag must be set. The last value written to the object via the bus or by the device will be read.

---

Function:	Pulse counter				
Object	Function	Name	Type	DPT	Flag
 41, 42, 43, ..., 46	Main counter end value	Input 1...6	2 byte	8,001	C, W <sup>1</sup>
Description	If the main counter is working as a down-counter, the input receives the end value of the main counter via this communication object. This object is visible when parameter "Specification of end value" is set to "Via communication object". As long as no correct value telegram is received, the input transmits an interval limit fault. The data format and data point type are set corresponding to the configured function of the pulse counter (here, pulse counter -32.768...32.767).				

---

Function:	Pulse counter				
Object	Function	Name	Type	DPT	Flag
 41, 42, 43, ..., 46	Main counter end value	Input 1...6	4 byte	12,001	C, W <sup>1</sup>
Description	If the main counter is working as a down-counter, the input receives the end value of the main counter via this communication object. This object is visible when parameter "Specification of end value" is set to "Via communication object". As long as no correct value telegram is received, the input transmits an interval limit fault. The data format and data point type are set corresponding to the configured function of the pulse counter (here, pulse counter 0...4.294.967.295).				

---

Function:	Pulse counter				
Object	Function	Name	Type	DPT	Flag
 41, 42, 43, ..., 46	Main counter end value	Input 1...6	4 byte	13,001	C, W <sup>1</sup>
Description	If the main counter is working as a down-counter, the input receives the end value of the main counter via this communication object. This object is visible when parameter "Specification of end value" is set to "Via communication object". As long as no correct value telegram is received, the input transmits an interval limit fault. The data format and data point type are set corresponding to the configured function of the pulse counter (here, pulse counter -2.147.483.648...2.147.483.647).				

---

Function:	Pulse counter				
Object	Function	Name	Type	DPT	Flag
 57, 58, 59, ..., 62	Disable main counter reset	Input 1...6	1-bit	1,003	C, W <sup>1</sup>
Description	Reset of the current main counter status can be disabled via this object. When parameter "Disable counter reset via KNX?" is set to "Yes", the counter reset function can be disabled via this object even if the reset is enabled in the parameters. During the time it is disabled, the meter cannot be reset. In the process, the polarity of the object is defined by parameter "Polarity of the disabling object".				

1: For reading, the R-flag must be set. The last value written to the object via the bus or by the device will be read.

---

Function:	Pulse counter				
Object	Function	Name	Type	DPT	Flag
<input type="checkbox"/> ← 65, 66, 67, ..., 70	Intermediate meter reading	Input 1...6	1 byte	5,010	C, -, T <sup>1</sup>
Description	This 1-bit object automatically transmits the current intermediate meter reading to the KNX (after changes or cyclically) when parameter "Permit automatic transmission of meter reading?" is set to "Yes". The meter reading can be read out via the KNX if the R-flag is set. The data format and data point type are set corresponding to the configured function of the pulse counter (here, pulse counter 0...255).				

---

Function:	Pulse counter				
Object	Function	Name	Type	DPT	Flag
<input type="checkbox"/> ← 65, 66, 67, ..., 70	Intermediate meter reading	Input 1...6	1 byte	6,010	C, -, T <sup>1</sup>
Description	This 1-bit object automatically transmits the current intermediate meter reading to the KNX (after changes or cyclically) when parameter "Permit automatic transmission of meter reading?" is set to "Yes". The meter reading can be read out via the KNX if the R-flag is set. The data format and data point type are set corresponding to the configured function of the pulse counter (here, pulse counter -128...127).				

---

Function:	Pulse counter				
Object	Function	Name	Type	DPT	Flag
<input type="checkbox"/> ← 65, 66, 67, ..., 70	Intermediate meter reading	Input 1...6	2 byte	7,001	C, -, T <sup>1</sup>
Description	This 2-bit object automatically transmits the current intermediate meter reading to the KNX (after changes or cyclically) when parameter "Permit automatic transmission of meter reading?" is set to "Yes". The meter reading can be read out via the KNX if the R-flag is set. The data format and data point type are set corresponding to the configured function of the pulse counter (here, pulse counter 0...65.535).				

---

Function:	Pulse counter				
Object	Function	Name	Type	DPT	Flag
<input type="checkbox"/> ← 65, 66, 67, ..., 70	Intermediate meter reading	Input 1...6	2 byte	8,001	C, -, T <sup>1</sup>
Description	This 1-bit object automatically transmits the current intermediate meter reading to the KNX (after changes or cyclically) when parameter "Permit automatic transmission of meter reading?" is set to "Yes". The meter reading can be read out via the KNX if the R-flag is set. The data format and data point type are set corresponding to the configured function of the pulse counter (here, pulse counter -32.768...32.767).				

1: For reading, the R-flag must be set. The last value written to the object via the bus or by the device will be read.

Function: Pulse counter

Object	Function	Name	Type	DPT	Flag
 65, 66, 67, ..., 70	Intermediate meter reading	Input 1...6	4 byte	12,001	C, -, T <sup>1</sup>

Description This 1-bit object automatically transmits the current intermediate meter reading to the KNX (after changes or cyclically) when parameter "Permit automatic transmission of meter reading?" is set to "Yes". The meter reading can be read out via the KNX if the R-flag is set. The data format and data point type are set corresponding to the configured function of the pulse counter (here, pulse counter 0...4.294.967.295).

Function: Pulse counter

Object	Function	Name	Type	DPT	Flag
 65, 66, 67, ..., 70	Intermediate meter reading	Input 1...6	4 byte	13,001	C, -, T <sup>1</sup>

Description This 1-bit object automatically transmits the current intermediate meter reading to the KNX (after changes or cyclically) when parameter "Permit automatic transmission of meter reading?" is set to "Yes". The meter reading can be read out via the KNX if the R-flag is set. The data format and data point type are set corresponding to the configured function of the pulse counter (here, pulse counter -2.147.483.648...2.147.483.647).

Function: Pulse counter

Object	Function	Name	Type	DPT	Flag
 73, 74, 75, ..., 78	Intermediate counter start value	Input 1...6	1 byte	5,010	C, W <sup>1</sup>

Description If the intermediate counter is working as an up-counter, the input receives the start value of the intermediate counter via this communication object. This object is visible when parameter "Specification of start value" is set to "Via communication object". As long as no correct value telegram is received, the input transmits an interval limit fault. The data format and data point type are set corresponding to the configured function of the pulse counter (here, pulse counter 0...255).

Function: Pulse counter

Object	Function	Name	Type	DPT	Flag
 73, 74, 75, ..., 78	Intermediate counter start value	Input 1...6	1 byte	6,010	C, W <sup>1</sup>

Description If the intermediate counter is working as an up-counter, the input receives the start value of the intermediate counter via this communication object. This object is visible when parameter "Specification of start value" is set to "Via communication object". As long as no correct value telegram is received, the input transmits an interval limit fault. The data format and data point type are set corresponding to the configured function of the pulse counter (here, pulse counter -128...127).

1: For reading, the R-flag must be set. The last value written to the object via the bus or by the device will be read.

---

Function:	Pulse counter				
Object	Function	Name	Type	DPT	Flag
 73, 74, 75, ..., 78	Intermediate counter start value	Input 1...6	2 byte	7,001	C, W <sup>1</sup>
Description	If the intermediate counter is working as an up-counter, the input receives the start value of the intermediate counter via this communication object. This object is visible when parameter "Specification of start value" is set to "Via communication object". As long as no correct value telegram is received, the input transmits an interval limit fault. The data format and data point type are set corresponding to the configured function of the pulse counter (here, pulse counter 0...65.535).				

---

Function:	Pulse counter				
Object	Function	Name	Type	DPT	Flag
 73, 74, 75, ..., 78	Intermediate counter start value	Input 1...6	2 byte	8,001	C, W <sup>1</sup>
Description	If the intermediate counter is working as an up-counter, the input receives the start value of the intermediate counter via this communication object. This object is visible when parameter "Specification of start value" is set to "Via communication object". As long as no correct value telegram is received, the input transmits an interval limit fault. The data format and data point type are set corresponding to the configured function of the pulse counter (here, pulse counter -32.768...32.767).				

---

Function:	Pulse counter				
Object	Function	Name	Type	DPT	Flag
 73, 74, 75, ..., 78	Intermediate counter start value	Input 1...6	4 byte	12,001	C, W <sup>1</sup>
Description	If the intermediate counter is working as an up-counter, the input receives the start value of the intermediate counter via this communication object. This object is visible when parameter "Specification of start value" is set to "Via communication object". As long as no correct value telegram is received, the input transmits an interval limit fault. The data format and data point type are set corresponding to the configured function of the pulse counter (here, pulse counter 0...4.294.967.295).				

---

Function:	Pulse counter				
Object	Function	Name	Type	DPT	Flag
 73, 74, 75, ..., 78	Intermediate counter start value	Input 1...6	2 byte	13,001	C, W <sup>1</sup>
Description	If the intermediate counter is working as an up-counter, the input receives the start value of the intermediate counter via this communication object. This object is visible when parameter "Specification of start value" is set to "Via communication object". As long as no correct value telegram is received, the input transmits an interval limit fault. The data format and data point type are set corresponding to the configured function of the pulse counter (here, pulse counter -2.147.483.648...2.147.483.647).				

1: For reading, the R-flag must be set. The last value written to the object via the bus or by the device will be read.

---

Function:	Pulse counter				
Object	Function	Name	Type	DPT	Flag
 81, 82, 83, ..., 86	Intermediate counter end value	Input 1...6	1 byte	5,010	C, W <sup>1</sup>
Description	If the intermediate counter is working as an up-counter, the input receives the end value of the intermediate counter via this communication object. This object is visible when parameter "Specification of end value" is set to "Via communication object". As long as no correct value telegram is received, the input transmits an interval limit fault. The data format and data point type are set corresponding to the configured function of the pulse counter (here, pulse counter 0...255).				

---

Function:	Pulse counter				
Object	Function	Name	Type	DPT	Flag
 81, 82, 83, ..., 86	Intermediate counter end value	Input 1...6	1 byte	6,010	C, W <sup>1</sup>
Description	If the intermediate counter is working as an up-counter, the input receives the end value of the intermediate counter via this communication object. This object is visible when parameter "Specification of end value" is set to "Via communication object". As long as no correct value telegram is received, the input transmits an interval limit fault. The data format and data point type are set corresponding to the configured function of the pulse counter (here, pulse counter -128...127).				

---

Function:	Pulse counter				
Object	Function	Name	Type	DPT	Flag
 81, 82, 83, ..., 86	Intermediate counter end value	Input 1...6	2 byte	7,001	C, W <sup>1</sup>
Description	If the intermediate counter is working as an up-counter, the input receives the end value of the intermediate counter via this communication object. This object is visible when parameter "Specification of end value" is set to "Via communication object". As long as no correct value telegram is received, the input transmits an interval limit fault. The data format and data point type are set corresponding to the configured function of the pulse counter (here, pulse counter 0...65.535).				

---

Function:	Pulse counter				
Object	Function	Name	Type	DPT	Flag
 81, 82, 83, ..., 86	Intermediate counter end value	Input 1...6	2 byte	8,001	C, W <sup>1</sup>
Description	If the intermediate counter is working as an up-counter, the input receives the end value of the intermediate counter via this communication object. This object is visible when parameter "Specification of end value" is set to "Via communication object". As long as no correct value telegram is received, the input transmits an interval limit fault. The data format and data point type are set corresponding to the configured function of the pulse counter (here, pulse counter -32.768...32.767).				

1: For reading, the R-flag must be set. The last value written to the object via the bus or by the device will be read.

---

Function:	Pulse counter				
Object	Function	Name	Type	DPT	Flag
 81, 82, 83, ..., 86	Intermediate counter end value	Input 1...6	4 byte	12,001	C, W <sup>1</sup>
Description	If the intermediate counter is working as an up-counter, the input receives the end value of the intermediate counter via this communication object. This object is visible when parameter "Specification of end value" is set to "Via communication object". As long as no correct value telegram is received, the input transmits an interval limit fault. The data format and data point type are set corresponding to the configured function of the pulse counter (here, pulse counter 0...4.294.967.295).				

---

Function:	Pulse counter				
Object	Function	Name	Type	DPT	Flag
 81, 82, 83, ..., 86	Intermediate counter end value	Input 1...6	4 byte	13,001	C, W <sup>1</sup>
Description	If the intermediate counter is working as an up-counter, the input receives the end value of the intermediate counter via this communication object. This object is visible when parameter "Specification of end value" is set to "Via communication object". As long as no correct value telegram is received, the input transmits an interval limit fault. The data format and data point type are set corresponding to the configured function of the pulse counter (here, pulse counter -2.147.483.648...2.147.483.647).				

---

Function:	Pulse counter				
Object	Function	Name	Type	DPT	Flag
 81, 82, 83, ..., 86	Intermediate counter start value	Input 1...6	1 byte	5,010	C, W <sup>1</sup>
Description	If the intermediate counter is working as a down-counter, the input receives the start value of the intermediate counter via this communication object. This object is visible when parameter "Specification of start value" is set to "Via communication object". As long as no correct value telegram is received, the input transmits an interval limit fault. The data format and data point type are set corresponding to the configured function of the pulse counter (here, pulse counter 0...255).				

---

Function:	Pulse counter				
Object	Function	Name	Type	DPT	Flag
 81, 82, 83, ..., 86	Intermediate counter start value	Input 1...6	1 byte	6,010	C, W <sup>1</sup>
Description	If the intermediate counter is working as a down-counter, the input receives the start value of the intermediate counter via this communication object. This object is visible when parameter "Specification of start value" is set to "Via communication object". As long as no correct value telegram is received, the input transmits an interval limit fault. The data format and data point type are set corresponding to the configured function of the pulse counter (here, pulse counter -128...127).				

1: For reading, the R-flag must be set. The last value written to the object via the bus or by the device will be read.

---

Function:	Pulse counter				
Object	Function	Name	Type	DPT	Flag
 81, 82, 83, ..., 86	Intermediate counter start value	Input 1...6	2 byte	7,001	C, W <sup>1</sup>
Description	If the intermediate counter is working as a down-counter, the input receives the start value of the intermediate counter via this communication object. This object is visible when parameter "Specification of start value" is set to "Via communication object". As long as no correct value telegram is received, the input transmits an interval limit fault. The data format and data point type are set corresponding to the configured function of the pulse counter (here, pulse counter 0...65.535).				

---

Function:	Pulse counter				
Object	Function	Name	Type	DPT	Flag
 81, 82, 83, ..., 86	Intermediate counter start value	Input 1...6	2 byte	8,001	C, W <sup>1</sup>
Description	If the intermediate counter is working as a down-counter, the input receives the start value of the intermediate counter via this communication object. This object is visible when parameter "Specification of start value" is set to "Via communication object". As long as no correct value telegram is received, the input transmits an interval limit fault. The data format and data point type are set corresponding to the configured function of the pulse counter (here, pulse counter -32.768...32.767).				

---

Function:	Pulse counter				
Object	Function	Name	Type	DPT	Flag
 81, 82, 83, ..., 86	Intermediate counter start value	Input 1...6	4 byte	12,001	C, W <sup>1</sup>
Description	If the intermediate counter is working as a down-counter, the input receives the start value of the intermediate counter via this communication object. This object is visible when parameter "Specification of start value" is set to "Via communication object". As long as no correct value telegram is received, the input transmits an interval limit fault. The data format and data point type are set corresponding to the configured function of the pulse counter (here, pulse counter 0...4.294.967.295).				

---

Function:	Pulse counter				
Object	Function	Name	Type	DPT	Flag
 81, 82, 83, ..., 86	Intermediate counter start value	Input 1...6	2 byte	13,001	C, W <sup>1</sup>
Description	If the intermediate counter is working as a down-counter, the input receives the start value of the intermediate counter via this communication object. This object is visible when parameter "Specification of start value" is set to "Via communication object". As long as no correct value telegram is received, the input transmits an interval limit fault. The data format and data point type are set corresponding to the configured function of the pulse counter (here, pulse counter -2.147.483.648...2.147.483.647).				

1: For reading, the R-flag must be set. The last value written to the object via the bus or by the device will be read.



---

Function:	Pulse counter				
Object	Function	Name	Type	DPT	Flag
 73, 74, 75, ..., 78	Intermediate counter end value	Input 1...6	1 byte	5,010	C, W <sup>1</sup>
Description	If the intermediate counter is working as a down-counter, the input receives the end value of the intermediate counter via this communication object. This object is visible when parameter "Specification of end value" is set to "Via communication object". As long as no correct value telegram is received, the input transmits an interval limit fault. The data format and data point type are set corresponding to the configured function of the pulse counter (here, pulse counter 0...255).				

---

Function:	Pulse counter				
Object	Function	Name	Type	DPT	Flag
 73, 74, 75, ..., 78	Intermediate counter end value	Input 1...6	1 byte	6,010	C, W <sup>1</sup>
Description	If the intermediate counter is working as a down-counter, the input receives the end value of the intermediate counter via this communication object. This object is visible when parameter "Specification of end value" is set to "Via communication object". As long as no correct value telegram is received, the input transmits an interval limit fault. The data format and data point type are set corresponding to the configured function of the pulse counter (here, pulse counter -128...127).				

---

Function:	Pulse counter				
Object	Function	Name	Type	DPT	Flag
 73, 74, 75, ..., 78	Intermediate counter end value	Input 1...6	2 byte	7,001	C, W <sup>1</sup>
Description	If the intermediate counter is working as a down-counter, the input receives the end value of the intermediate counter via this communication object. This object is visible when parameter "Specification of end value" is set to "Via communication object". As long as no correct value telegram is received, the input transmits an interval limit fault. The data format and data point type are set corresponding to the configured function of the pulse counter (here, pulse counter 0...65.535).				

---

Function:	Pulse counter				
Object	Function	Name	Type	DPT	Flag
 73, 74, 75, ..., 78	Intermediate counter end value	Input 1...6	2 byte	8,001	C, W <sup>1</sup>
Description	If the intermediate counter is working as a down-counter, the input receives the end value of the intermediate counter via this communication object. This object is visible when parameter "Specification of end value" is set to "Via communication object". As long as no correct value telegram is received, the input transmits an interval limit fault. The data format and data point type are set corresponding to the configured function of the pulse counter (here, pulse counter -32.768...32.767).				

1: For reading, the R-flag must be set. The last value written to the object via the bus or by the device will be read.

Function: Pulse counter

Object	Function	Name	Type	DPT	Flag
 73, 74, 75, ..., 78	Intermediate counter end value	Input 1...6	4 byte	12,001	C, W <sup>1</sup>

Description If the intermediate counter is working as a down-counter, the input receives the end value of the intermediate counter via this communication object. This object is visible when parameter "Specification of end value" is set to "Via communication object". As long as no correct value telegram is received, the input transmits an interval limit fault. The data format and data point type are set corresponding to the configured function of the pulse counter (here, pulse counter 0...4.294.967.295).

Function: Pulse counter

Object	Function	Name	Type	DPT	Flag
 73, 74, 75, ..., 78	Intermediate counter end value	Input 1...6	4 byte	13,001	C, W <sup>1</sup>

Description If the intermediate counter is working as a down-counter, the input receives the end value of the intermediate counter via this communication object. This object is visible when parameter "Specification of end value" is set to "Via communication object". As long as no correct value telegram is received, the input transmits an interval limit fault. The data format and data point type are set corresponding to the configured function of the pulse counter (here, pulse counter -2.147.483.648...2.147.483.647).

Function: Pulse counter

Object	Function	Name	Type	DPT	Flag
 89, 90, 91, ..., 94	Intermediate counter message: counter has elapsed	Input 1...6	1-bit	1,002	C, -, T <sup>1</sup>

Description This 1-bit object reports that the intermediate counter has elapsed to the KNX. Only visible when parameter "Report elapsed counter to KNX?" is set to "Yes".

Function: Pulse counter

Object	Function	Name	Type	DPT	Flag
 97, 98, 99, ..., 102	Intermediate counter message, interval limit fault	Input 1...6	1-bit	1,002	C, -, T <sup>1</sup>

Description This 1-bit object reports an intermediate counter interval limit fault to the KNX. An interval limit fault is transmitted when:  
 - Up-counter: Start value >= End value  
 Down-counter: Start value <= End value  
 The interval limit fault is also read out if the communication objects "start value" and "end value" have not yet received a valid value telegram via the KNX.

1: For reading, the R-flag must be set. The last value written to the object via the bus or by the device will be read.

Function: Pulse counter

Object	Function	Name	Type	DPT	Flag
 105, 106, 107, ... 110	Intermediate counter, polling counter status	Input 1...6	1-bit	1,017	C, W <sup>1</sup>

Description: 1-bit object for polling the current intermediate counter status. If this object is defined with a "1" telegram, the device transmits the current meter reading to the KNX. This communication object is only visible when parameter "Permit counter status polling via KNX?" is set to "Yes".

Function: Pulse counter

Object	Function	Name	Type	DPT	Flag
 113, 114, 115, ... 118	Reset intermediate meter reading	Input 1...6	1-bit	1,015	C, W <sup>1</sup>

Description: 1-bit object for resetting the intermediate counter. If this object is defined with a "1" telegram, the meter reading is reset to the start value that was configured or specified via an object. This communication object is only visible when parameter "Permit counter reset via KNX?" is set to "Yes".

Function: Pulse counter

Object	Function	Name	Type	DPT	Flag
 121, 122, 123, ... 126	Disable intermediate counter reset	Input 1...6	1-bit	1,003	C, W <sup>1</sup>

Description: Reset of the current intermediate counter status can be disabled via this object. When parameter "Disable counter reset via KNX?" is set to "Yes", the counter reset function can be disabled via this object even if the reset is enabled in the parameters. During the time it is disabled, the meter cannot be reset. In the process, the polarity of the object is defined by parameter "Polarity of the disabling object".

## Objects for the disabling function

Function: Disabling function

Object	Function	Name	Type	DPT	Flag
 16, 17, 18, ... 21	Disabling switching object X.1	Input 1...6	1-bit	1,003	C, W, - <sup>1</sup>

Description: 1-bit object for disabling the first switching object of an input (polarity configurable). Only for the "Switching" function!

1: For reading, the R-flag must be set. The last value written to the object via the bus or by the device will be read.

Function: Disabling function

Object	Function	Name	Type	DPT	Flag
 24, 25, 26, ..., 29	Disabling switching object X.2	Input 1...6	1-bit	1,003	C, W, - 1

Description 1-bit object for disabling the second switching object of an input (polarity configurable).  
Only for the "Switching" function!

Function: Disabling function

Object	Function	Name	Type	DPT	Flag
 16, 17, 18, ..., 21	Disabling	Input 1...6	1-bit	1,003	C, W, - 1

Description 1-bit object for disabling an input (polarity configurable).  
Only for the "Dimming", "Venetian blind" and "Value transmitter" functions.

1: For reading, the R-flag must be set. The last value written to the object via the bus or by the device will be read.

## 4.2.4 Functional description

### 4.2.4.1 Application basics

#### Signal types and signal evaluation

The device has 6 independent inputs that electrical signals in the voltage range 10...230V can be connected to. In this way, it is possible to read states from suitable switches, push-buttons or comparable contacts and to supply them to the KNX as sensor commands. The device also evaluates direct voltage signals (DC) as well as alternating voltage signals (AC). The device records switching edges of the voltage signals and thereby determines the states of the contacts connected.

#### Direct voltage signals (DC):

The device scans the signal voltage cyclically and separately detects switching DC voltage signals both statically and cyclically (switch position change at a switching frequency of up to a max. of 30 Hz) for up to 6 inputs. The debounce time (8...255 ms), generally configured for all outputs in the ETS, defines for which duration a signal that was not previously present, must be present interruption-free on an input in order to be detected reliably as "1" signal (rising edge / switched-on state). A signal that was detected previously as switched on must be switched off interruption-free for the same amount of time so that the device identifies a "0" signal (falling edge / switched-off state). In the case of DC signals switching cyclically in a fast sequence, care must be taken to ensure that the selected debounce time is not too long so that all switching edges can be reacted to.

The device detects signal voltages within the range 0...2 V reliably as "low" (voltage not present). Voltages within the range 7...230 V are detected reliably as "high" (voltage present).

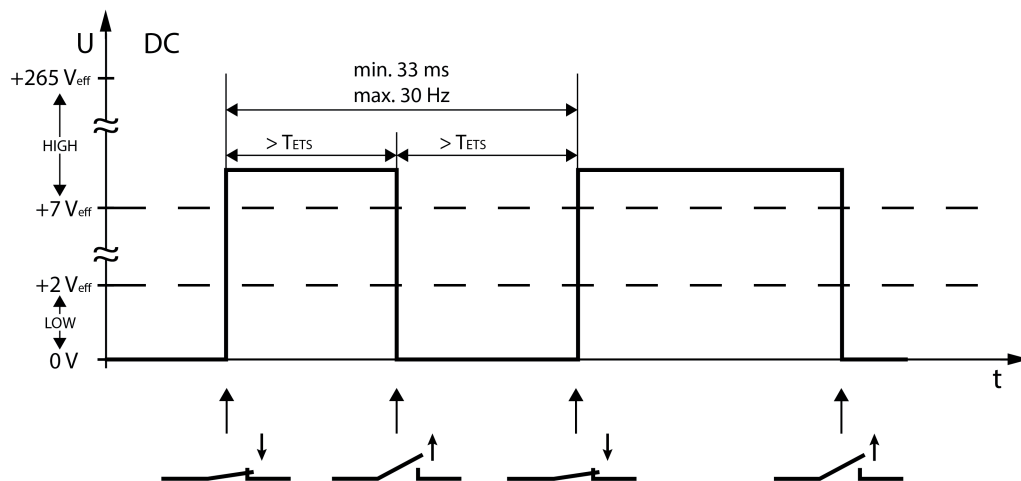

Figure 6: Example for a signal sequence of a direct voltage signal (DC)

$T_{ETS}$  = ETS debounce time

#### Alternating voltage signals (AC):

The device scans the alternating signal voltage in the polarity and reliably detects separate alternating voltage signals with a frequency of 30...60 Hz for up to 6 inputs. The device detects a "1" signal (rising edge / switched-on state) if a certain number of positive scan impulses were detected (high, voltage present) within the debounce time. The necessary number of positive scanning impulses is attuned to the specified signal frequency and stored permanently in the

device. If no further positive scanning impulse could be determined for the duration of the debounce time after a signal was detected as switched on previously, the device identifies a "0" signal (falling edge / switched-off state).

If the case of alternating voltage signals, the debounce time is defined from two values. A fixed value of 20 ms assures successful signal evaluation of all possible signal frequencies. The debounce time (8...255 ms) configured in the ETS is added to this fixed value. The debounce time for the described signal evaluation of the device is defined by the sum of these two values. The device detects signal voltages within the range 0...2 V reliably as "low" (voltage not present). Voltages within the range 7...230 V are detected reliably as "high" (voltage present).

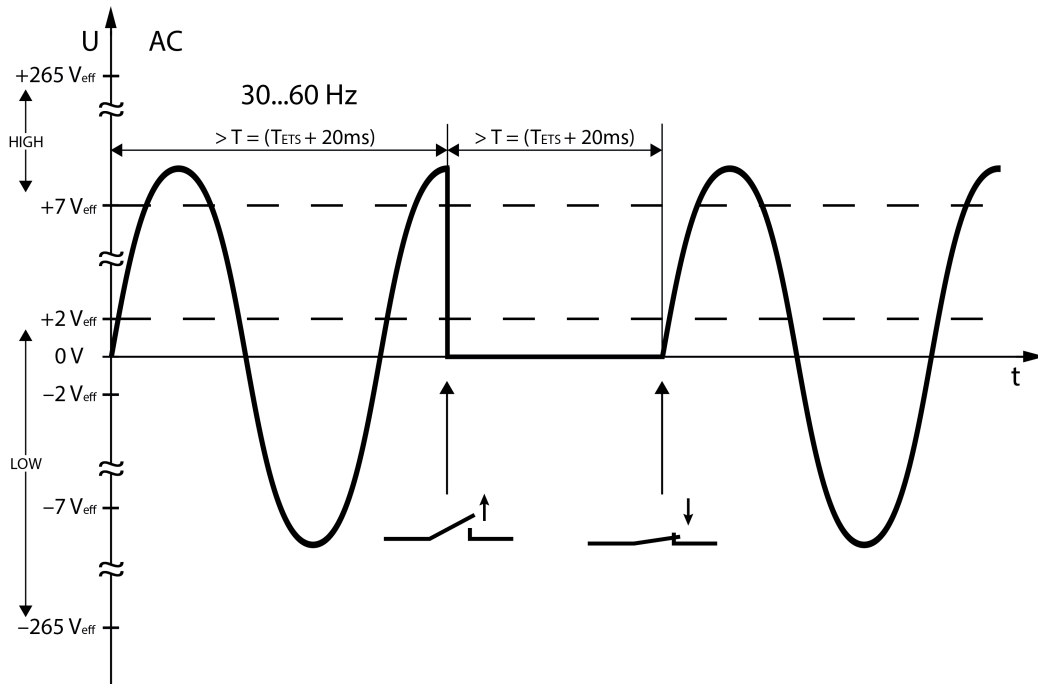

Figure 7: Example for a signal sequence of an alternating voltage signal (AC)

T = Total debounce time

T<sub>ETS</sub> = ETS debounce time

Since, as described, the signal types must be scanned and interpreted differently, the device needs the information as to which voltage type is present (AC or DC) for each input in the switched on state. The parameter "voltage type" specifies signal type and defines the scanning behaviour of the corresponding input.

- i The debounce time is used to prevent the device from mistakenly identifying short conduction faults as a signal.

- i** The telegram output is normally influenced by the switching edges of the signals. Each switching edge can also request a bus telegram depending on the KNX function configured. It is important to note that the speed at which the device sends the telegrams to the bus depends on the bus load! In the case of a high bus load and fast switching signals (10...30 Hz), individual switching frequencies can no longer be transmitted reliably by the telegram output. In such cases, the switching frequency of the signals at the input must be reduced or the bus load must be reduced!

## 4.2.4.2 Description of channel-independent functions

### Delay after bus voltage return

It is possible to specify separately for each input whether a reaction should take place after a device reset (bus voltage return or ETS programming operation). This means that a defined telegram can be transmitted to the KNX according to the input signal or with forced control. The configured "Delay after bus voltage return" for the inputs on the "General" parameter page must have elapsed fully by the time the set reaction is executed. Within the delay, any pending edges or signals at the inputs are not evaluated and are ignored. The delay time is configured generally for all the inputs.

- i Inputs configured to the "Switching" function can send the object value cyclically. The cyclical transmission can start automatically after bus voltage return or after an ETS programming operation. In this case, the "Delay after bus voltage return" prevents the cyclical transmission. A cyclical transmission is first performed after the delay time has elapsed.
- i Inputs configured to the "Pulse counting" function can transmit counter statuses cyclically. The cyclical transmission can start automatically after bus voltage return or after an ETS programming operation. In this case, the "Delay after bus voltage return" prevents the cyclical transmission. A cyclical transmission is first performed after the delay time has elapsed.

### Debounce time

On the parameter page "General", the debounce time of the signal is defined by the device software via the parameter "debounce time". The debounce time enables you to jointly define for all binary inputs after which activation period the binary inputs identify a valid actuation of the connected contacts. In this way, it is possible to prevent the device from mistakenly identifying short conduction faults as a signal. The debounce time makes it possible to adapt the signal evaluation to the contact quality of the connected switches or push-buttons as well. The debounce time must be increased in the ETS if undesirable signal evaluations with very fast edge changes occur regularly or sporadically resulting in rapidly changing states of the bus telegrams.

### Telegram rate limit

It is possible to configure a general telegram rate limit using the parameter of the same name on the "General" parameter page. If the telegram rate limit is enabled, no more telegrams are transmitted to the KNX in 17 seconds (permanently defined, cyclical time interval) than is specified in the ETS. This avoids fast edge changes at the inputs causing an impermissibly high bus load.

- i A telegram rate limit does not influence a configured delay after a bus voltage return. These two functions can be combined in any way.



### 4.2.4.3 Channel-oriented functional description

The following section contains descriptions of the various functions that can be configured in the ETS independently for each input. The functions "Switching", "Dimming", "Venetian blind", "Value transmitter" or "Pulse counter" can be set.

#### 4.2.4.3.1 "Switching" function

##### "Switching" function

For each input whose function is set to "Switching", the ETS displays two 1-bit communication objects (switching object X.1 and X.2). It is possible to use these two objects to transmit different switching telegrams to the bus depending on the signal edge at the input. The input parameter on the parameter page "Input x" (x = 1...6) can be used to define which object value is transmitted to the bus when there is a rising or falling edge at the input (no reaction, ON, OFF, TOGGLE - switchover of the object value). No distinction is made between a brief or long signal edge/actuation in the "Switching" function.

##### Response to bus voltage return

After a device reset (bus voltage return or ETS programming operation), the communication objects of the input can be initialised. For this, the "Behaviour on bus voltage return" parameter should be configured to the required reaction. In the settings "On telegram" or "Off telegram" telegrams are transmitted actively to the bus according to this requirement. In the "Transmit current input status" setting, the device evaluates the static signal status of the input and, according to this, transmits the appropriately configured telegram to the bus (contact closed at the input = telegram as with rising edge; contact open at input = telegram as with falling edge). If, in this case, the edge command dependent on the current status is configured to "No reaction", the device does not transmit a telegram to the bus on initialisation. If, in the ETS, a delay is set for the inputs after bus voltage return, the device only transmits the telegrams when the delay has elapsed. (see page 40); the device only transmits the telegrams when the delay has elapsed.

##### Cyclical transmission

Optionally, the object values can be transmitted cyclically to the bus for the "Switching" function. For this, the transmission criteria must first be defined in the ETS. The "Transmit cyclically ?" parameter on the parameter page "Ex - Transmit cyclically" (x = 1...6) specifies with which value cyclical transmission should take place. Depending on requirements, it is possible to transmit cyclically via both or just one switching object(s). In addition, it is possible to define the cycle time separately for both switching objects in the ETS.

The object value entered in the switching objects by the device on a edge change or externally by the bus is always transmitted cyclically. The object value is then also transmitted cyclically when "no reaction" is assigned to a rising or falling edge. Cyclical transmission also takes place directly after bus voltage return, if the object (possibly influenced by the parameter "Reaction after bus voltage return") corresponds to the transmission criterion for cyclical transmission. A "Delay after bus voltage return", if configured, is expected in this case.

During an active disable, no cyclical transmissions take place via the disabled input.

## 4.2.4.3.2 "Dimming" function

### "Dimming" function

For each input whose function is set to "Dimming", the ETS indicates a 1-bit "Switching" and a 4-bit "Dimming" object. In general, the device transmits a switching telegram on a short time input signal (triggered by the rising edge of a closed contact) and a dimming telegram on a long signal. In the standard configuration, the device transmits a telegram for stopping the dimming action after a long signal.

The length of time the input signal (closed push-button or switch) must last until a long actuation is detected can be set using the parameter "Time between switching and dimming" on the parameter page "Input x" (x = 1...6).

### Operating principle

The "Operation" parameter specifies the operating principle. In the presetting of the dimming function, dual-area operation is specified here. This means that the input transmits a telegram for switching on after a short signal length and a telegram for increasing the brightness after a long signal length ("Brighter"). Alternatively, the device can transmit a telegram for switching off after a short signal length and a telegram for reducing the brightness after a long signal length ("Darker").

With a single-surface dimming function, the input transmits switch-on and switch-off telegrams ("TOGGLE") in an alternating pattern for each short signal. After long signals, the device transmits "brighter" and "darker" telegrams in an alternating pattern.

- i** With single-surface dimming, the following should be observed: if a dimming actuator is to be controlled from several locations, a faultless single-area operation requires that the addressed actuator reports its switching state back to the 1-bit object of the input and that the 4-bit objects of all the sensors are interlinked. The sensor device would otherwise not be able to detect that the actuator has been addressed from another sensor, in which case it would have to be actuated twice during the next use in order to produce the desired reaction.

The additional input parameters on the parameter page "Input x" (x = 1...6) can be used to specify in which step width brighter or darker dimming take place, whether a stop telegram is transmitted on a falling edge or whether the dimming telegram is to be repeated cyclically.

### Response to bus voltage return

After a device reset (bus voltage return or ETS programming operation), the communication object "Switching" of the input can be initialised. For this, the "Behaviour on bus voltage return" parameter should be configured to the required reaction. In the settings "On telegram" or "Off telegram" telegrams are transmitted actively to the bus.

If, in the ETS, a delay is set for the inputs after bus voltage return, the device only transmits the telegrams when the delay has elapsed.

After a device reset, the "Dimming" object is always initialised with "0".

## 4.2.4.3.3 "Venetian blind" function

### "Venetian blind" function

For each input, whose function is set to "Venetian blind", the ETS indicates the two 1-bit objects "Short time operation" and "Long time operation".

For the control of Venetian blind, roller shutter, awning or similar drives, the device supports two operation concepts for the Venetian blind function in which the telegrams are transmitted in different time sequences. The device can therefore be used to operate a wide variety of drive configurations. In the ETS, the operating concept of an input is defined using the parameter of the same name on the parameter page "Input x" (x = 1...6). The following settings are possible...

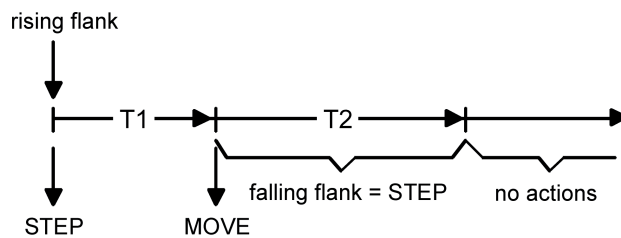

Figure 8: Operation concept "short – long – short"

### Operation concept "short – long – short"

In the operation concept "short – long – short", the input shows the following behaviour:

- Immediately after a rising edge (closed push-button or switch) the input transmits a short time telegram onto the bus. Pressing the button stops a running drive and starts time T1 ("time between short time and long time operation"). If the a falling edge is detected within T1 (closed push-button or switch), no further telegram will be transmitted. This short time serves the purpose of stopping a continuous movement. The "Time between short time and long time command" in the input parameters should be selected shorter than the short time operation of the actuator to prevent a jerky movement of the shutter.
- If the button is kept depressed longer than T1, the input transmits a long time telegram after the end of T1 for starting up the drive and time T2 ("slat adjusting time") is started.
- If a falling edge is detected within the slat adjustment time, the input transmits an additional short time telegram. This function is used for adjusting the slats of a blind. The function permits stopping the slats in any position during their rotation. The "slat adjusting time" should be chosen as required by the drive for a complete rotation of the slats. If the "slat adjusting time" is selected longer than the complete travelling time of the drive, a pushbutton function is possible as well. This means that the drive is active only when a button connected to the input is kept depressed.
- If the button is kept depressed longer than T2, the input transmits no further telegram. The drive remains on until the end position is reached.

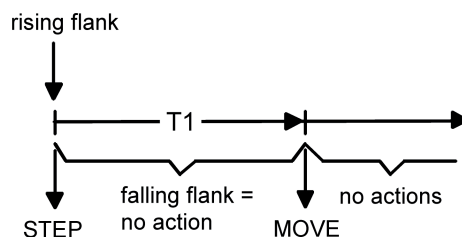

Figure 9: Operation concept "long – short"

Operation concept "long – short":

In the operation concept "long – short", the input shows the following behaviour:

- Immediately on pressing the button, the input transmits a long time telegram. The drive begins to move and time T1 ("slat adjusting time") is started.
- If a falling edge is detected within the slat adjustment time, the input transmits a short time telegram. This function is used for adjusting the slats of a blind. The function permits stopping the slats in any position during their rotation.  
The "slat adjusting time" should be chosen as required by the drive for a complete rotation of the slats. If the "slat adjusting time" is selected longer than the complete travelling time of the drive, a pushbutton function is possible as well. This means that the drive is active only when a button connected to the input is kept depressed.
- If the button is kept depressed longer than T1, the input transmits no further telegram. The drive remains on until the end position is reached.

### Edge evaluation

The parameter "Command on rising edge" on the parameter page "Input x" (x = 1..6) specifies the direction of movement of the short time or long time telegram. In the "TOGGLE" setting (single-area operation) the input switches the direction of the short and long time telegram each time there is a new signal. Several short time telegrams in succession have the same direction.

- i** If the actuator is to be controlled from several locations, a faultless single-area operation requires that the all long time objects of the sensor devices are interlinked. A sensor device would otherwise not be able to detect that the actuator has been addressed from another sensor, in which case it would have to be actuated twice during the next use in order to produce the desired reaction.

### Response to bus voltage return

After a device reset (bus voltage return or ETS programming operation), the communication object "Long-time operation" of the input can be initialised. For this, the "Behaviour on bus voltage return" parameter should be configured to the required reaction. In the settings "Up" or "Down", telegrams are transmitted actively to the bus.

If, in the ETS, a delay is set for the inputs after bus voltage return, the device only transmits the telegrams when the delay has elapsed.

After a device reset, the "Short-time operation" object is always initialised with "0".

## 4.2.4.3.4 "Value transmitter" function

### "Value transmitter" function

For each input whose function is set to "Value transmitter", the ETS indicates either a 1-byte or a 2-byte object. The data format of the value object is dependent on the set function of the value transmitter. The "Function as" parameter on the parameter page "Input x" (x = 1...6) defines the function on one of the following value transmitter applications...

- Dimming value transmitter (1-byte),
- Light scene extension without memory function (1-byte),
- Light scene extension with memory function (1-byte),
- Temperature value transmitter (2-bytes),
- Brightness value transmitter (2-bytes),

The dimming value transmitter, temperature and brightness value transmitter different in data format and in the range of values. The independent function of the light scene extension is special and is described below.

#### Dimming value transmitter, temperature and brightness value transmitter

In the function as a dimming value transmitter, the input can transmitted unformatted integers in the range 0 ... 255 to the bus. As a brightness value transmitter, the input transmits formatted floating point values in the range 0 ... 1500 Lux and, as a temperature value transmitter, in the range 0 ... 40 °C. Table 1 shows a summary of the value ranges of the value encoders. The values to be transmitted are configured in the ETS and can be adjusted later during device operation (see value adjustment below).

The edge evaluation of the device means that it can transmit values only on a rising edge, only on a falling edge or on a rising and falling edge. In this way, it is possible to make adjustments to the contact connected at the input (push-button as NC contact or NO contact and switch).

Value transmitter type	Function	Lower numerical limit	Upper numerical limit
Dimming value transmitter	0 ... 255	0	255
Temperature value transmitter	Temperature value	0 °C	40 °C
Brightness value transmitter	Brightness value	0 lux	1.500 lux

Table 1: Value ranges of dimming value transmitter, temperature and brightness value transmitter

#### Value adjustment for dimming value transmitter, temperature and brightness value transmitter

With the dimming value transmitter and the temperature and brightness value transmitter, the value to be transmitted can be adjusted at any time during device operation. A value adjustment can only be configurable in the ETS when the value is to be transmitted only on a rising edge or only on a falling edge, i.e. a push-button is connected to the input.

A value adjustment is introduced by a long signal at the input (> 5 s) and continues for as long as the signal is detected as active, i.e. the push-button is actuated. With the first adjustment after commissioning, the value programmed by the ETS is increased cyclically by the step width configured for the dimming value transmitter and transmitted. The step width of the temperature value transmitter (1 °C) and the brightness value transmitter (50 Lux) is permanently defined. The previously transmitted value is saved after releasing the pushbutton. The next long pushbutton actuation adjusts the saved value and the direction of the value adjustment changes.

The time between two telegrams on adjusting values can be configured in the ETS.

Example of value adjustment (figure 10):

- Function as dimming value transmitter
- Transmit value on = Rising edge

- Value configured in the ETS for rising edge = 17
- Step width = 5

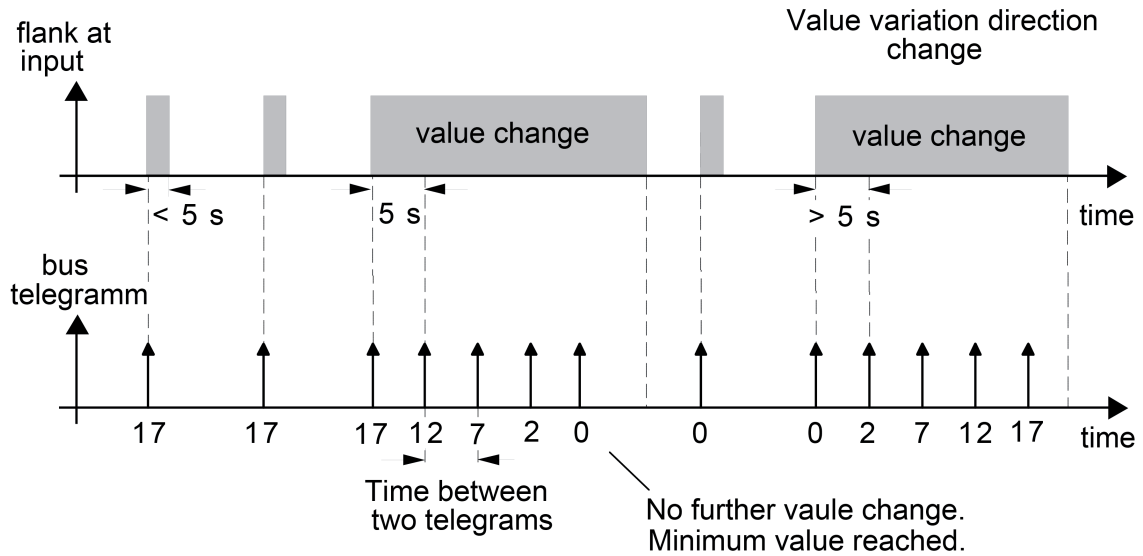

Figure 10: Example to change the value for dimming value transmitter

- i** There is no value over- or underrun on adjustment. If, during an adjustment, the maximum or minimum value is reached (see Table 1), no more telegrams are transmitted.
- i** To ensure that, during a value adjustment, for example the controlled lighting switches off or switches on at the maximum, the limit values (e.g. the values "0" or "255") are always transmitted when the limits of the adjustable range are reached. This also takes place when the configured step width of these values is not immediately taken into account (see example above: step width = 5; value "2" is transmitted, then value "0"). In this case, to ensure that the original starting value can be reset on resetting with a change to the adjustment direction, the first value jump is not equal to the preset step width (see example above: step width = 5; value "0" is transmitted, then values "2"; "7" etc.).
- i** The newly adjusted values are stored in RAM. After a device reset (bus voltage failure or ETS programming operation), the adjusted values are replaced by the values originally configured in the ETS.

### Light scene extension

With a configuration as a light scene extension without a memory function, it is possible to recall a light scene, which is stored in an external KNX subscriber (e.g. light scene pushbutton sensor) With a rising, falling or rising and falling edge, the light scene number configured in the ETS is immediately transmitted to the bus.

With a configuration as a light scene extension with a memory function, it is possible to generate a memory telegram according to the light scene to be transmitted. For this, the appropriate memory telegram is transmitted for a long signal according to the configured edge evaluation (push-button as NC contact or NO contact - not as switch!). In this case, the time for long actuation can be configured (but not to below 5 s). With short actuation  $< 1\text{ s}$ , the configured light scene number (without memory telegram) is transmitted. If the actuation last longer than 1 s but less than 5 s, no telegram is triggered.

In addition, there is the option of only transmitting a memory telegram without prior light scene recall. In this case, the parameter "Only memory function ?" must be set to "Yes".

Examples for a light scene extension with memory function (figure 11):

- 1.) Only memory function = No
- 2.) Only memory function = Yes

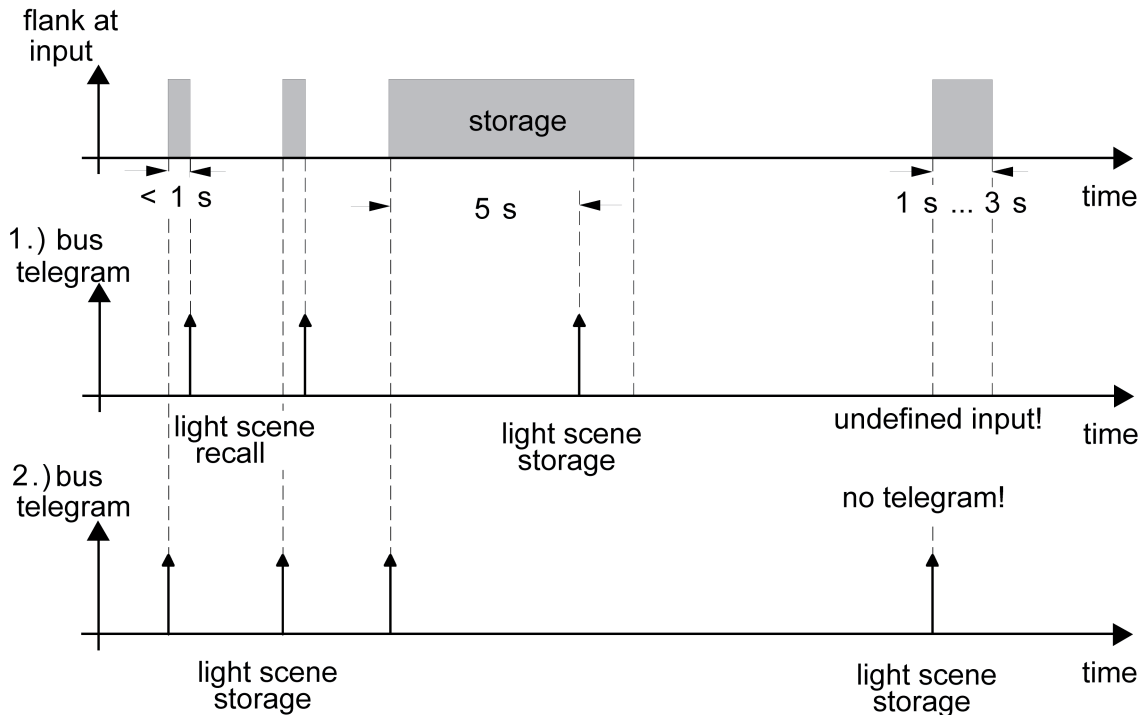

Figure 11: Example of scene storage

**"Only memory function = No":**

If a rising or falling edge is detected at the input (according to the configuration), the time recording operation begins. If actuation ceases during the first second, the appropriate light scene recall takes place immediately. If the signal length is longer, then the memory telegram is transmitted after 5 s.

**"Only memory function = Yes":**

The memory telegram is transmitted immediately after detection of the appropriate signal edge.

Behaviour on bus voltage return for value transmitter and light scene extension

After a device reset (bus voltage return or ETS programming operation), the communication object of the value transmitter or light scene extension can be initialised. For this, the "Behaviour on bus voltage return" parameter should be configured to the required reaction. The setting is dependent on the value transmitter function and edge evaluation selected in the ETS. In the settings "Reaction as rising edge" or "Reaction as falling edge", telegrams are transmitted actively to the bus according to the configuration in the ETS. In the "Transmit current input status" setting, the device evaluates the static signal status of the input and, according to this, transmits the appropriately configured telegram to the bus (contact closed at the input = telegram as with rising edge; contact open at input = telegram as with falling edge). This setting can only be configured with "Transmit value on = rising and falling edge (switch)". If, in the ETS, a delay is set for the inputs after bus voltage return, the device only transmits the telegrams when the delay has elapsed.

## 4.2.4.3.5 "Pulse counter" function

For each input on which the function is set to "pulse counter", the ETS displays up to 16 communication objects. To an extent, the object data formats are dependent on the set pulse counter function.

When functioning as a pulse counter, the input can count the number of pulses at a channel input.

As soon as an input is set to the "pulse counter" function, two pulse counters are available to it. The main counter and the intermediate counter are equally controlled by the pulse at the input, but count independently of each other. Both meters are configured independently of each other on separate parameter pages ("Ex - Main counter" and "Ex - Intermediate counter").

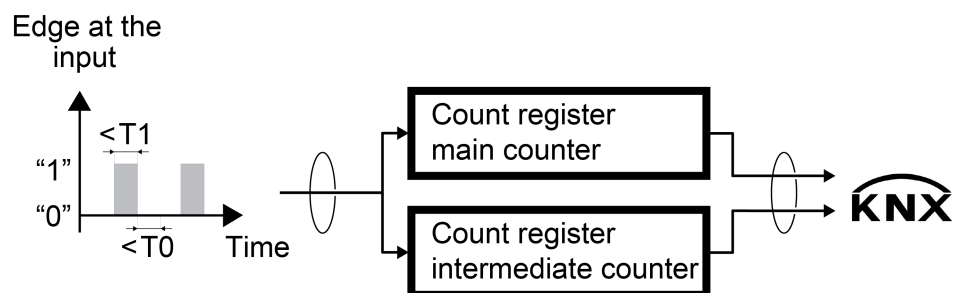

Figure 12: Pulse counter, functional diagram

T0 Minimum signal duration for "0" signals

T1 Minimum signal duration for "1" signals

### Function of the pulse counter

The following basic settings for the function of the pulse counter are to be configured for the main and intermediate counters together on the parameter page "Ex - Function". These basic settings cannot differentiate between the main and primary counters.

- Size and interval of the countable value range (parameter "Function")
- Signal evaluation in the device (parameter "Counting the pulses at the input for")
- Ratio of pulses emitted by the pulse generator to the pulses counted in the device (parameter "Pulses at input per counted pulse")
- Factor of the change in counter status per counted pulse (parameter "Change in counter status per counted pulse")
- Debounce time or minimum signal duration
- Handling the meter reading after return of bus voltage or ETS download

### Size and interval of the countable value range

For each input on which the function is set to "pulse counter", the ETS displays up to 16 communication objects. To an extent, the data formats are dependent on the set pulse counter function. The "Function" parameter on the parameter page "Ex - function" (x = 1...6)" defines the value range of the pulse counter to one of the following sizes and intervals:

- Pulse counter 0...255 (1 byte / KNX DPT 5.010)
- Pulse counter -128...127 (1 byte / KNX DPT 6.010)



- Pulse counter 0...65.535 (2 byte / KNX DPT 7.001)
- Pulse counter -32.768...32.767 (2 byte / KNX DPT 8.001)
- Pulse counter 0...4.294.967.295 (4 byte / KNX DPT 12.001)
- Pulse counter -2.147.483.647...2.147.483.647 (4 byte / KNX DPT 13.001)

The different functions of the pulse counter differ only in the size and interval of the countable value range. The manner in which the pulses are counted is defined through the parameters in the ETS. To do so, the ETS provides different parameters with which the function of the pulse counter can be individually adapted independently of the set function of the pulse counter.

### Signal evaluation in the device

The signal evaluation in the device is defined in the ETS. The device can recognise pulses by rising and/or falling edges. Parameter "Counting the pulses at the input" on the parameter page "Ex - Function" specifies the edge which initiates signal evaluation in the device. The following settings in the ETS are possible:

- on rising edge
- on falling edge
- on rising and falling edge

### Ratio of pulses emitted by the pulse generator to the pulses counted in the device

Parameter "Pulses at input per counted pulse" on the parameter page "Ex - function" (x = 1...6)" defines the ratio of pulses received at the input to the pulses counted in the device. The binary input works with a designed debounce time or minimum signal duration. The shortest time here is 100 ms.

<b>Example for setting the pulses at the input per counted pulse (figure 13):</b>
- "Function" = Pulse counter 0...65535
- "Counting the pulses at the input for" = Rising edge
- "Pulses at input per counted pulse" = 4
- "Change in counter status per counted pulse" = 1

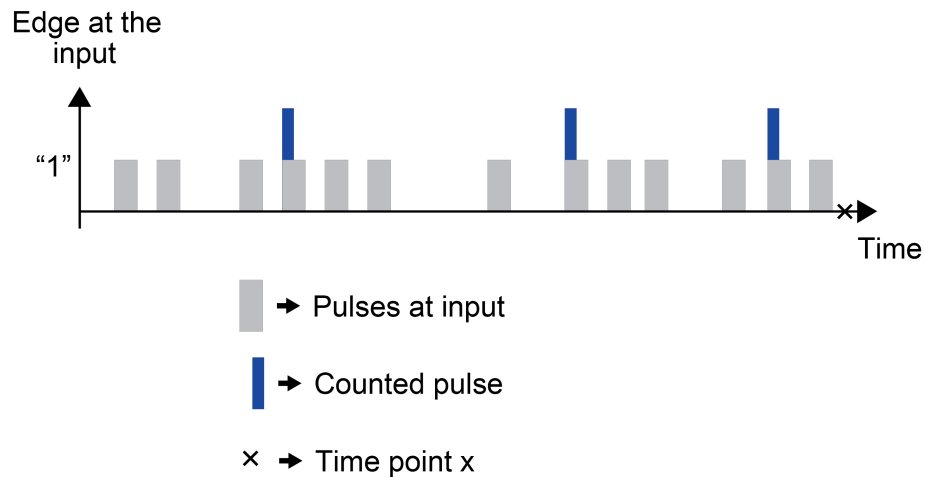

Figure 13: Example for setting the pulses at the input per counted pulse

The device internally counts the meter reading up for each counted pulse (up-counter) or down (down-counter). Thus, in this example the up-counter has a meter reading of 3. At time point x, the communication "... meter reading" sends a "3" to the KNX at time point x.

#### Factor of the change in counter status per counted pulse

Parameter "Change in counter status per counted pulse" on the parameter page "Ex - Function" (x = 1...6) defines the factor for the counter status increase resulting from each counted pulse.

#### **Example for setting the number of changes in counter status per counted pulse (figure 14):**

- "Function" = Pulse counter 0...65535
- "Counting the pulses at the input for" = Rising edge
- "Pulses at input per counted pulse" = 2
- "Change in counter status per counted pulse" = 5

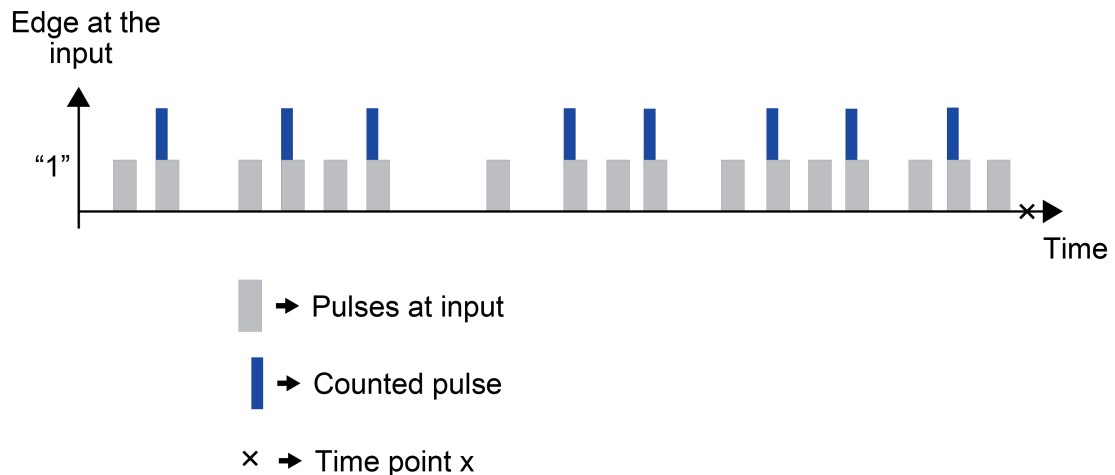

Figure 14: Example for setting the number of changes in counter status per counted pulse

The device internally counts the meter reading up for each counted pulse (up-counter) or down (down-counter). To determine the counter status, the value of the configured "Change in counter status per counted pulse" is multiplied by the number of counted pulses. Thus, in this example an up-counter has a meter reading of "40". Parameter "Pulses at input per counted pulse" defines the ratio of pulses received at the input to the pulses counted in the device (17 pulses at the input -> 8 counted pulses). The communication object "... meter reading" sends a "40" to the KNX at time point x.

### Debounce time or minimum signal duration

Parameter "Activate minimum signal duration" on the parameter page "Ex - Function" (x = 1...6)" decides whether the input works with a definable time for the signal debouncing or with a minimum signal duration for "0" or "1" signals when the pulse counter function is configured.

If "Debounce time" is configured, the input immediately responds to an edge at the input. When the edge is detected at the input, a timer in the device begins to determine the time since the edge was detected. The input does not evaluate any pulses for the configured debounce duration.

If "Minimum signal duration" has been configured, when an edge is detected at the input, a timer in the device begins to determine the time since the detection. The input only evaluates the pulse after the configured minimum signal duration has elapsed. The signal must remain stable during the minimum signal duration.

The debounce time of the signal is defined by the device software via the parameter "Debounce time". When the pulse counter function is configured, the duration which must elapse between two pulses for a valid pulse of the connected contacts to be identified is defined for the input via the debounce time. In this way, it is possible to prevent the device from mistakenly identifying short conduction faults as a pulse. The debounce time makes it possible to adapt the signal evaluation to the contact quality of the connected pulse output also.

Increase the debounce time in the ETS if undesirable pulse evaluations with very fast edge changes resulting in rapidly changing telegram states occur regularly or sporadically.

With parameter "Minimum signal duration for ...", The times of the minimum signal duration for "0" and "1" signals is determined by the device software. When the pulse counter function is configured, the period during which a pulse must be present until a valid pulse is identified is defined for the input via the minimum signal duration. Different times can be defined for "0" and "1" signals here. In this way, it is possible to prevent the device from mistakenly identifying short conduction faults as a pulse.

**Example for setting the minimum signal duration (figure 15):**

- "Function" = Pulse counter 0...65535
- "Counting the pulses at the input for" = Rising edge
- "Pulses at input per counted pulse" = 1
- "Change in counter status per counted pulse" = 1

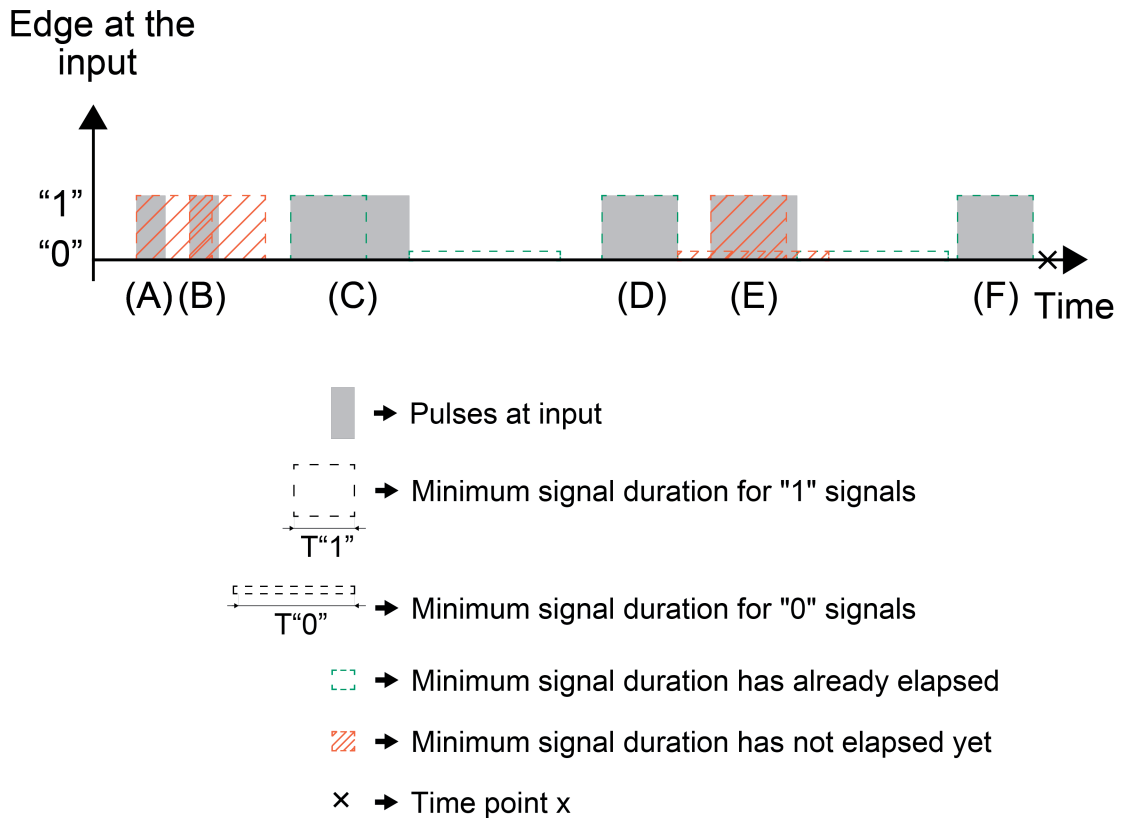

Figure 15: Example for setting the minimum signal duration

- (A) The duration of this pulse is shorter than the minimum signal duration defined for "1" signals. This pulse is not identified as a valid pulse by the device.
- (B) The duration of this pulse is shorter than the minimum signal duration defined for "1" signals. This pulse is not identified as a valid pulse by the device.
- (C) The duration of this pulse is longer than the minimum signal duration defined for "1" signals. This pulse is identified as a valid pulse by the device.
- (D) The duration of this pulse is equal to the minimum signal duration defined for "1" signals. The minimum signal duration for "0" signals has already elapsed. This pulse is identified as a valid pulse by the device.
- (E) The duration of this pulse is equal to the minimum signal duration defined for "1" signals. However, the minimum signal duration for "0" signals has not elapsed yet. This pulse is not identified as a valid pulse by the device.

- (F) The duration of this pulse is equal to the minimum signal duration defined for "1" signals. The minimum signal duration for "0" signals has already elapsed. This pulse is identified as a valid pulse by the device.

The device internally counts the meter reading up for each pulse (up-counter) or down (down-counter). To determine the counter status, the device evaluates the minimum signal duration set for the "0" and "1" signals. In this example, first the minimum signal duration for "0" signals must elapse after a valid pulse has been identified. Only then can the device recognise a "1" signal as a valid pulse again. Thus, in this example the up-counter has a meter reading of 3. At time point x, the communication "... meter reading" sends a "3" to the KNX at time point x.

### Handling the meter reading after return of bus voltage or ETS download

Parameters "Send counter status after bus voltage return?" and "Reset counter status after ETS download?" on the parameter page "Ex - function" (x = 1...6) define the behaviour of the device when handling the counter statuses of the main and intermediate counters.

- i** The parameter settings are valid until the next time these parameters are adjusted in the ETS. The configured behaviour after bus voltage returns and after an ETS download is taken into account with each ETS download.

### **Main counter and intermediate counter**

The following pulse counter settings are to be configured on the parameter pages "Ex - Main counter" and "Ex - Intermediate counter". These settings are to be considered separately for the main and intermediate counters. The functions of the main and intermediate counters are identical except for a few parameter settings and so are described together here. The following parameters are different for the main and intermediate counters:

- "Behaviour after counter status polled via KNX"
- "Send meter reading"
- "Behaviour after counter has elapsed"

The counting direction can be separately defined for the main and intermediate counters in the ETS parameters. The meters function as either up- or down-counters. Regardless of counting direction, pulse counting begins at the start value and ends at the end value. The start and end values can be specified for the device via parameter or communication object. The value range in which the start/end values lie is oriented to the set function (see chapter 4.2.4.3.5. "Pulse counter" function) of the pulse counter. When setting via parameter, the start and end values of the pulse counting are specified directly in the ETS. In this case, the preset default value is also oriented to the counter's counting direction. When setting via communication object, communication objects to specify the start and end values are enabled. The data format of the communication objects is oriented to the set function of the pulse counter.

- i** Condition (up-counter): Start value < End value

- i** Condition (down-counter): Start value > End value

The communication objects "... Start value" and "... End value" have the value "0" after a programming procedure. Therefore the greater than / less than condition is not satisfied. The meter has stopped and is in interval limit fault state. The interval limit fault is reported to the communication object of the same name on the KNX. As soon as the meter has received valid start and end values, the interval limit fault is cancelled and confirmed with a "0" telegram. The meter is ready for operation. Start and end values can be changed via the communication objects at any time. Parameter "Behaviour after meter has elapsed" defines the behaviour of the meter when the end value received via the communication object is greater or less than

(depending on the counting direction) the current meter reading.

If there is a power failure or a new programming procedure, the start and end values previously specified via communication object are saved within the device. Once the device restarts, these values are set as start and end values again. Whether the counter statuses are sent after bus voltage is restored or set again after a programming procedure is defined via the parameters on the parameter page "Ex - Function" for the main and intermediate counters together (see chapter 4.2.4.3.5. "Pulse counter" function).

- i** Start and end values specified via communication object also remain saved within the device after a discharge process.

The device has the option of sending current counter statuses to the KNX after changes, cyclically, or after changes and cyclically. The meter reading can also be sent cyclically with subsequent reset only in the parameter configuration of the intermediate counter.

The meter reading is optionally sent when parameter "Permit automatic transmission of meter reading?" is set to "Yes". Whether the device sends the meter reading after changes or cyclically is defined with parameter "Send meter reading".

If the meter reading should be sent after changes, parameter "Send meter reading for value changes of" defines the exact value by which the meter reading must change for the device to send the correct meter reading again. The value range of this parameter is oriented to the set function (see chapter 4.2.4.3.5. "Pulse counter" function) of the pulse counter.

Cyclical transmission of the counter status can take place in an interval of 10 seconds to 23 hours : 59 minutes : 59 seconds. The device always transmits the meter reading cyclically after the time defined in the parameters has elapsed. The intermediate counter offers the possibility to transmit the meter reading after the cycle time has ended and then reset it. This behaviour enables pulse counting over a specified interval.

- i** A counter status change caused by a change of the start or end values does not result in transmission of the counter status. Transmission of the counter status after changes only occurs via the recognition of input pulses.

With the meter reading polling function, the device offers another possibility to send the counter status to the KNX. In this case, the device only transmits the meter reading if the counter status is polled via communication object. Parameter "Permit counter status polling via KNX?" enables the corresponding communication object. This function can be used in parallel with the automatic transmission. The behaviour of the main counter after a counter status polling via KNX is permanently defined. The main counter continues to run after the counter status is polled. This is one aspect in which the main counter differs from the intermediate counter. The behaviour of the intermediate counter after a counter status polling via KNX can be defined with the same parameters. After a counter status polling, the intermediate counter can either continue to run or be reset and restarted. The device transmits the meter reading status before the meter reading is reset and the meter restarted.

When the specified end value is reached, the meter has elapsed. Optionally, an elapsed counter can be reported with a KNX telegram via the communication object "... Elapsed counter report". This communication object is enabled when parameter "Report elapsed counter to KNX?" is set to "Yes".

Another function which is different between the main and intermediate counters is the behaviour after the counter elapses. Parameter "Behaviour after meter elapses" is permanently set to "Meter is reset and restarted" on the parameter page "Ex - Main counter". On the parameter page "Ex - Intermediate counter", this parameter decides whether the intermediate counter is reset and restarted or if it stays elapsed.

When "Intermediate meter is reset and restarted" is set, the meter counts until the defined end

value. Once this end value is reached, the meter reading is reset and the meter begins counting pulses from the defined start value again.

When "Intermediate counter stays elapsed" is set, the intermediate meter counts until the defined end value. Once this end value is reached, the intermediate counter stops counting. The intermediate counter must be reset before it can start counting pulses from the defined start value again. The corresponding communication object "... Reset meter reading" is enabled with parameter "Permit counter reset via KNX?" date?". This parameter is permanently set to "Yes" when "Meter stays elapsed" is set.

- i** In the same way, the configured "Behaviour after meter has elapsed" defines the behaviour of the meter when the end value received via the communication object is greater or less than (depending on the counting direction) the current meter reading.

The counter reset via KNX can be set separately for the main and "... intermediate counters of each input via the communication object "...Reset meter reading" when parameter "Permit counter reset via KNX?" is set to "Yes". During a counter reset, the meter reading is reset to the start value and the meter is restarted. The function of the communication object "... Reset meter reading" can be disabled, thus preventing an accidental counter reset. The communication object which temporarily disables the possibility to reset a counter is enabled when parameter "Disable counter reset via KNX" is set to "Yes". During the disabled period (polarity of disabling object can be set), KNX telegrams to the communication object "... Reset meter reading" are ignored and the meter cannot be reset. After the disabling is cancelled by a new KNX telegram with reversed polarity, the meter reading can again be reset.

### Overview: Functions of the main and intermediate counters

Two pulse counters are available for one input. The main counter and the intermediate counter are equally controlled by the pulse at the input, but count independently of each other. Both meters are configured independently of each other on separate parameter pages ("Ex - Main counter" and "Ex - Intermediate counter"). Project design of the main and intermediate counters is slightly different.

Function	Main counter	Intermediate counter
Can the data format of the counter be set?	Yes	Yes
Are counter statuses saved if there is a bus voltage failure?	Yes	Yes
Can start and end values can be specified in the parameters?	Yes	Yes
Can start and end values can be specified via communication objects?	Yes	Yes
Can the counting direction be set?	Yes	Yes
Can the meter reading be polled via a KNX communication object?	Yes	Yes
Can the behaviour of the counter after a counter status polling via KNX be set?	No	Yes
Can the meter reading be independently transmitted by the device?	Yes	Yes
Can the meter reading be reset automatically and the meter restarted after the status has been cyclically transmitted?	No	Yes

---

Can an elapsed counter be reported via a KNX telegram?	Yes	Yes
Can the behaviour of the counter after it has elapsed be defined?	No	Yes
Can the meter be reset and restarted with a KNX telegram?	Yes	Yes



#### 4.2.4.3.6 Disabling functions of the inputs

The binary inputs can be separately disabled via the bus using 1-bit objects. With the "Switching" function, it is possible to disable the two switching objects of an input independently of each other.

With an active disabling function, signal edges at the input are ignored by the device related to the affected objects.

Each input or each switching object can execute a specific independent reaction at the beginning or end of a disable. This reaction is specified on the parameter page "Ex - disable" (x = 1...6) in the ETS and is dependent on the edge evaluation defined for the affected input. In so doing, it is possible to configure to "No reaction". Only in this case are dimming or Venetian blind control operations or value adjustments completed during an active disable and only then the input locked. In all other cases, the configured disabling command is executed immediately at the beginning of disabling.

The disabling function (parameter page "Ex - Disable" (x = 1...6)) can only be configured for the following functions:

- Switching
- Dimming
- Venetian blind
- Value transmitter

In the "Transmit current input status" setting, the device evaluates the actual static signal status of the input and, according to this, transmits the appropriately configured telegram to the bus (contact closed at the input = telegram as with rising edge; contact open at input = telegram as with falling edge).

A disabling function is activated or deactivated by the corresponding 1-bit object. The telegram polarity can be set in the ETS for each disabling object. The disabling object is always inactive after a device reset. Even with an inverted polarity "Disabling = 0 (Enabling = 1)", a "0" telegram must first be received after a reset until the appropriate disabling function is activated.

- i** Updates to disabling objects with the same telegram polarity (disabling -> disabling or enabling -> enabling) do not show a reaction.
- i** With cyclical transmission in the "Switching" function: during an active disable, cyclical transmission does not take place via the disabled input switching object. Cyclical transmission is continued immediately at the end of the disabling with the last object value written to the object, provided that the transmission criterion for cyclical transmission is fulfilled ("transmit on ON, on OFF" or "on ON and OFF").

#### 4.2.4.4 Delivery state

In the unprogrammed state as delivered, the device is passive, i.e. no telegrams are transmitted to the bus. The device can be programmed and put into operation via the ETS. The physical address is preset to 15.15.255

In the state as delivered, the status LEDs display the signal state of the inputs on the front panel of the device, i.e. the LEDs work even without an ETS programming operation. If, however, the application program present in the as-delivered state is unloaded by the ETS, or another non-executable application program is programmed, the status LED is also without function!

## 4.2.5 Parameters

### 4.2.5.1 General parameters

Description	Values	Comment
<input type="checkbox"/> General		
Delay after bus voltage return Minutes (0...59)	<b>0...59</b>	<p>It is possible to specify separately for each input whether a reaction should take place after a device reset (bus voltage return or ETS programming operation). This means that a defined telegram can be transmitted to the bus according to the input signal or with forced control. The delay time for the binary inputs configurable at this point must have elapsed fully by the time the set reaction is executed. Within the delay, any pending edges or signals at the inputs are not evaluated and are ignored.</p> <p>Setting the delay time minutes for binary inputs.</p>
Seconds (0...59)	<b>0...17...59</b>	<p>Setting the delay time seconds for binary inputs.</p>
Milliseconds (0...9 x 100)	<b>0...9</b>	<p>Setting the delay time milliseconds for binary inputs.</p>
Debounce time (8...255 ms)	<b>8...30...255</b>	<p>This parameter specifies the software debounce time for all binary inputs together. Depending on the quality of the connected contacts, you can define here after which activation period the binary inputs detect a valid actuation.</p> <p><b>i</b> Inputs for which the function is set to "pulse counter" ignore the debounce time set here. The debounce time / minimum signal duration are set separately for this function, related to each input.</p>
Telegram rate limit	<b>Disabled</b> <b>enabled</b>	<p>Here it is possible to configure a general telegram rate limit. If the telegram rate limit is enabled, no more telegrams are transmitted to the bus in 17 seconds (permanently defined, cyclical time interval) than is specified by the parameter "Telegrams per 17 s". This avoids fast edge changes at the inputs causing an impermissibly high bus load. It is important to note that the configured "Delay on bus voltage return" is also</p>

Telegrams per 17 s      **30**, 60, 100, 127

active during this time. The configured behaviour on bus voltage return will only be executed once the 17 seconds have elapsed!

Setting the telegram rate (telegrams in 17 s) for the telegram rate limit. Only visible on "Telegram rate limit = enabled".

## 4.2.5.2 Parameter for the binary inputs

Description	Values	Comment
□-  Input 1		
Voltage type	<b>Direct voltage (DC)</b> Alternating voltage (AC)	The voltage type present on the binary input can be set separately for each input and has an influence on the scanning and detection of the connected signal.
Function input 1	No function <b>Switching</b> Dimming Venetian blind Value transmitter Pulse counter	The basic function of the appropriate binary input is defined here. The same functions are available for all inputs. In the "no function" setting, the input is deactivated.

### 4.2.5.2.1 Parameters for "Switching" function

Description	Values	Comment
□-  "Switching" function input 1		
Command on rising edge Switching object 1.1	No reaction <b>ON</b> OFF TOGGLE	This parameter can be used to define which object value is transmitted first to the bus via the first communication object of the input when there is a rising edge (TOGGLE - switchover of the object value).
Command on falling edge Switching object 1.1	No reaction ON <b>OFF</b> TOGGLE	This parameter can be used to define which object value is transmitted first to the bus via the first communication object of the input when there is a falling edge (TOGGLE - switchover of the object value).
Command on rising edge Switching object 1.2	<b>No reaction</b> ON OFF TOGGLE	This parameter can be used to define which object value is transmitted first to the bus via the second communication object of the input when there is a rising edge (TOGGLE - switchover of the object value).
Command on falling edge Switching object 1.2	<b>No reaction</b> ON OFF TOGGLE	This parameter can be used to define which object value is transmitted first to the bus via the second communication object of the input when there is a falling edge (TOGGLE - switchover of the object value).

Behaviour after bus  
voltage  
return

After a device reset (bus voltage return or ETS programming operation), the communication objects of the input can be initialised. If, in the ETS, a delay is set for the inputs after bus voltage return, the device only transmits the telegrams when the delay has elapsed.

**No reaction**

After a device reset, no reaction takes place automatically (no telegram is transmitted to the bus).

Send ON telegram

In this configuration, an "ON" telegram is actively transmitted to the bus after a device reset.

Send OFF telegram

In this configuration, an "OFF" telegram is actively transmitted to the bus after a device reset.

Transmit current input  
status

In this setting, the device evaluates the static signal status of the input and, according to this, transmits the appropriately configured telegram to the bus (contact closed at the input = telegram as with rising edge; contact open at input = telegram as with falling edge). If, in this case, the edge command dependent on the current status is configured to "No reaction", the device does not transmit a telegram to the bus on initialisation.

## 4.2.5.2.2 Parameters for the "Dimming" function

Description	Values	Comment
□-  "Dimming" function input 1		
Operation		This parameter specifies the reaction to a rising edge at the input.
	Single-area operation: darker/brighter (TOGGLE)	With a short signal length at the input, the object value of the switching object is toggled and an appropriate telegram transmitted. With a long signal length, a dimming telegram (brighter / darker). The dimming direction is only stored internally and switched on sequential dimming operations.
	<b>Dual-area operation: brighter (ON)</b>	With a short signal length at the input, an ON telegram is triggered and, if there is a long signal length, a dimming telegram (brighter) is triggered.
	Dual-area operation: darker (OFF)	With a short signal length at the input, an OFF telegram is triggered and, if there is a long signal length, a dimming telegram (darker) is triggered.
	Dual-area operation: brighter (TOGGLE)	With a short signal length at the input, the object value of the switching object is toggled and an appropriate telegram transmitted, if there is a long signal length, a dimming telegram (brighter) is triggered.
	Dual-area operation: darker (TOGGLE)	With a short signal length at the input, the object value of the switching object is toggled and an appropriate telegram transmitted, if there is a long signal length, a dimming telegram (darker) is triggered.
Time between switching and dimming Seconds (0...59)	<b>0...59</b>	Time from which the dimming function ("long signal length") is executed. Sets the time seconds.
Milliseconds (4...9 x 100)	<b>4...9</b>	Sets the time milliseconds.
Behaviour after bus voltage return		After a device reset (bus voltage return or ETS programming operation), the communication object "Switching" of the input can be initialised. If, in the ETS, a delay is set for the inputs after bus voltage return, the device only transmits the telegrams when the delay has elapsed.
	<b>no reaction</b>	After a device reset, no reaction takes place automatically (no telegram is transmitted to the bus).
	Send ON telegram	

		In this configuration, an "ON" telegram is actively transmitted to the bus after a device reset.
	Send OFF telegram	In this configuration, an "OFF" telegram is actively transmitted to the bus after a device reset.
Increase brightness by	<b>100 %</b> 50 % 25 % 12.50 % 6 % 3 % 1.50 %	A dimming telegram can increase brightness by a maximum of X %. This parameter determines the maximum dimming step width for a dimming telegram. This parameter depends on the set operation.
Reduce brightness by	<b>100 %</b> 50 % 25 % 12.50 % 6 % 3 % 1.50 %	A dimming telegram can increase darkness by a maximum of X %. This parameter determines the maximum dimming step width for a dimming telegram. This parameter depends on the set operation.
Send stop telegram ?	No <b>Yes</b>	One or no telegram is transmitted on releasing a pushbutton at the input (falling edge).
Telegram repeat?	No Yes	It is possible to use this parameter to determine whether the dimming telegram should be repeated cyclically for a long signal length (actuation of a pushbutton at the input).
Time between two telegrams Seconds (0...59)	0... <b>1</b> ...59	Time between two telegrams when telegram repetition is active. A new dimming telegram is transmitted after this time has elapsed. Sets the time seconds.
Milliseconds (5...9 x 100)	<b>5</b> ...9	Sets the time milliseconds.



## 4.2.5.2.3 Parameters for the "Venetian blind" function

Description	Values	Comment
<p>☐ "Venetian blind" function input 1</p> <p>Command on rising edge</p>	<p>No function</p> <p><b>UP</b></p> <p>DOWN</p> <p>TOGGLE</p>	<p>This parameter specifies the reaction to a rising edge at the input.</p> <p>The input is deactivated.</p> <p>A short time telegram (UP) is triggered by a short signal length and a long time telegram (high) is triggered by a long signal length.</p> <p>A short time telegram (DOWN) is triggered by a short signal length and a long time telegram (low) is triggered by a long signal length.</p> <p>With this setting, the direction is switched over internally long signal length (MOVE). If a short time signal transmits a STEP telegram, then this STEP is always switched in the opposite direction of the last MOVE. Several STEP telegrams transmitted successively are switched in the same direction.</p>
<p>Behaviour after bus voltage return</p>	<p><b>No reaction</b></p> <p>up</p> <p>Down</p>	<p>After a device reset (bus voltage return or ETS programming operation), the communication object "Long-time operation" of the input can be initialised. If, in the ETS, a delay is set for the binary inputs after bus voltage return, the device only transmits the telegrams when the delay has elapsed.</p> <p>After a device reset, no reaction takes place automatically (no telegram is transmitted to the bus).</p> <p>In this configuration, an "UP" telegram is actively transmitted to the bus after a device reset.</p> <p>In this configuration, an "DOWN" telegram is actively transmitted to the bus after a device reset.</p>
<p>Operation concept</p>	<p><b>short – long - short</b></p>	<p>This parameter specifies the telegram sequence after actuation (rising edge).</p> <p>A STEP is transmitted with a rising edge and the "Time between short and long time operation" started. This STEP serves the purpose of stopping a continuous movement. If, within the started time, a falling edge is detected, the input does not transmit an additional telegram. If no falling edge was detected</p>

			<p>during the time, a MOVE is transmitted automatically after the time has elapsed and the "slat adjustment time" is started. If a falling edge is detected within the slat adjustment time, the input transmits a STEP. This function is used for slat adjustment. The "slat adjusting time" should correspond to the time required for a 180° rotation of the slats.</p>
	long - short		<p>A MOVE is transmitted when there is a rising edge at the input and the "slat adjustment time" started. If a falling edge is detected within the started time, the input transmits a STEP. This function is used for slat adjustment. The "slat adjusting time" should correspond to the time required for a 180° rotation of the slats.</p>
Time between step and move operation Seconds (0...59)	<b>0</b> ...59		<p>Time after which the function of a long actuation is executed. Only visible with "Operation concept = "Short – Long – Short". Sets the time seconds.</p>
Milliseconds (4...9 x 100)	<b>4</b> ...9		<p>Sets the time milliseconds.</p>
Slat adjusting time Seconds (0...59)	0... <b>2</b> ...59		<p>Time during which a long time telegram for slat adjustment can be terminated by a falling edge at the input. Sets the time seconds.</p>
Milliseconds (0...9 x 100)	<b>0</b> ...9		<p>Sets the time milliseconds.</p>

## 4.2.5.2.4 Parameters for the "Value transmitter" function

Description	Values	Comment
□-  "Value transmitter" function input 1		
Function as	<p><b>Dimming value transmitter</b></p> <p>Light scene extension without memory function</p> <p>Light scene extension with memory function</p> <p>Temperature value transmitter</p> <p>Brightness value transmitter</p>	<p>This parameter specifies the value transmitter function to be executed. The data format of the value object is dependent on the set function of the value transmitter.</p>
Transmit value on	<p><b>rising edge (push-button as NO contact)</b></p> <p>falling edge (push-button as NC contact)</p> <p>rising and falling edge (switch)</p>	<p>This parameter specifies the edge which starts signal evaluation in the device. The setting "rising and falling edge (switch)" cannot be selected with the value transmitter function "Light scene recall with memory function".</p>
Value on rising edge (0...255)	0... <b>100</b> ...255	<p>This parameter specifies the value transmitted on a rising edge. Only visible with "Dimming value transmitter" and "Transmit value on = rising edge (push-button as NO contact)" and "Transmit value on = rising and falling edge (switch)".</p>
Value on falling edge (0...255)	<b>0</b> ...255	<p>This parameter specifies the value transmitted on a falling edge. Only visible with "Dimming value transmitter" and "Transmit value on = falling edge (push-button as NC contact)" and "Transmit value on = rising and falling edge (switch)".</p>
Light scene on rising edge (1...64)	<b>1</b> ...64	<p>This parameter specifies the light scene number transmitted on a rising edge. Only visible with "Light scene recall" and "Transmit value on = rising edge (push-button as NO contact)" and "Transmit value on = rising and falling edge (switch)".</p>
	<b>1</b> ...64	

<p>Light scene on falling edge (1...64)</p>	<p>This parameter specifies the light scene number transmitted on a falling edge. Only visible with "Light scene recall" and "Transmit value on = falling edge (push-button as NC contact)" and "Transmit value on = rising and falling edge (switch)".</p>
<p>Value on rising edge (0...40 x 1 °C)</p> <p>0 °C...<b>20 °C</b>...40 °C</p>	<p>This parameter specifies the temperature value transmitted on a rising edge. Only visible with "Temperature value transmitter" and "Transmit value on = rising edge (push-button as NO contact)" and "Transmit value on = rising and falling edge (switch)".</p>
<p>Value on falling edge (0...40 x 1 °C)</p> <p>0 °C...<b>18 °C</b>...40 °C</p>	<p>This parameter specifies the temperature value transmitted on a falling edge. Only visible with "Temperature value transmitter" and "Transmit value on = falling edge (push-button as NC contact)" and "Transmit value on = rising and falling edge (switch)".</p>
<p>Value on rising edge</p> <p>0 Lux...<b>200 Lux</b>...1.500 Lux</p>	<p>This parameter specifies the brightness value (in 50 Lux steps) transmitted on a rising edge. Only visible with "Brightness value transmitter" and "Transmit value on = rising edge (push-button as NO contact)" and "Transmit value on = rising and falling edge (switch)".</p>
<p>Value on falling edge</p> <p><b>0 Lux</b>...1,500 Lux</p>	<p>This parameter specifies the brightness value (in 50 Lux steps) transmitted on a falling edge. Only visible with "Brightness value transmitter" and "Transmit value on = falling edge (push-button as NC contact)" and "Transmit value on = rising and falling edge (switch)".</p>
<p>Behaviour after bus voltage return</p>	<p>After a device reset (bus voltage return or ETS programming operation), the communication object of the value transmitter or light scene extension can be initialised. If, in the ETS, a delay is set for the binary inputs after bus voltage return, the device only transmits the telegrams when the delay has elapsed.</p>
<p><b>No reaction</b></p>	

		<p>After a device reset, no reaction takes place automatically (no telegram is transmitted to the bus).</p>
	Reaction as rising edge	<p>In this configuration, a telegram is actively transmitted to the bus after a device reset in accordance with the configuration for the rising edge. This setting can only be configured with "Transmit value on = rising edge (switch)".</p>
	Reaction as falling edge	<p>In this configuration, a telegram is actively transmitted to the bus after a device reset in accordance with the configuration for the falling edge. This setting can only be configured with "Transmit value on = falling edge (switch)".</p>
	Transmit current input status	<p>In this setting, the device evaluates the static signal status of the input and, according to this, transmits the appropriately configured telegram to the bus (contact closed at the input = telegram as with rising edge; contact open at input = telegram as with falling edge). This setting can only be configured with "Transmit value on = rising and falling edge (switch)".</p>
Adjustment via long actuation	<p><b>No</b> <b>Yes</b></p>	<p>With the dimming value transmitter and the temperature and brightness value transmitter, the value to be transmitted can be adjusted at any time during device operation. A value adjustment can only be configured here when the value is to be transmitted only on a rising edge or only on a falling edge, i.e. a push-button is connected to the input. A value adjustment is introduced by a long signal at the input (&gt; 5 s) and continues for as long as the signal is detected as active, i.e. the push-button is actuated.</p> <p>With the first adjustment after commissioning, the value programmed by the ETS is increased cyclically by the step width configured for the dimming value transmitter and transmitted. The step width of the temperature value transmitter (1 °C) and the brightness value transmitter (50 Lux) is permanently defined. The previously transmitted value is saved after releasing the pushbutton. The next long pushbutton actuation adjusts the saved value and the direction of the value adjustment changes.</p>

		Only visible with "Transmit value on = rising edge (push-button as NO contact)" and "Transmit value on = falling edge (push-button as NC contact)".
Time between two telegrams Seconds (0...59)	0... <b>1</b> ...59	The time between two telegrams on adjusting values can be configured here. Only visible on "Adjustment via long actuation = Yes". Sets the time seconds.
Milliseconds (5...9 x 100)	<b>5</b> ...9	Sets the time milliseconds.
Step width (1...10)	1... <b>10</b>	Step width by which the adjusted value is increased or decreased with long actuation. Only visible on "Function as = Dimming value transmitter".

## 4.2.5.2.5 Parameters for the "Pulse counter" function

Description	Values	Comment
□-  "Pulse counter" function input 1		
Function	Pulse counter 0...255 (1-byte / KNX DPT 5.010)	The "Function" parameter defines the value range of the pulse counter. The size and interval of the counting range are set in dependence on this setting.
	Pulse counter -128...127 (1-byte / KNX DPT 6.010)	
	<b>Pulse counter 0...65,535 (2-byte / KNX DPT 7.001)</b>	
	Pulse counter 32.768...32,767 (2-byte / KNX DPT 8.001)	
	Pulse counter 0...4294967295 (4 bytes / KNX DPT 12.001)	
Counting the pulses at the input for	<b>rising edge</b>	The device can recognise pulses by rising and/or falling edges. This parameter specifies the edge which starts signal evaluation in the device.
	falling edge	
	rising and falling edge	
Pulses at input per counted pulse	1 ... 10000	This parameter defines the ratio of pulses received at the input to the pulses counted in the device. The number of valid pulses specified here must be detected at the device input so the pulse counter can count a pulse.
Change in counter status per counted pulse	1 ... 10000	Parameter "Change in counter status per counted pulse" defines the factor for the change in counter status resulting from each counted pulse. The change in counter status is yielded by multiplying the factor entered here with the pulses counted by the pulse counter.
Activate minimum signal duration?	Yes	Parameter "Activate minimum signal duration?" decides whether the input works with a definable time for the signal
	<b>No</b>	

		debouncing or with a minimum signal duration for "0" or "1" signals when the pulse counter function is configured.
		With the "Yes" setting, additional parameters which define the minimum signal duration for "0" and "1" signals become visible.
		When "No" is set, the device works with a debounce time in milliseconds defined with the parameter of the same name.
Debounce time Milliseconds	<b>100 ... 255</b>	Parameter "Debounce time" defines the signal debounce time through the device software. When the pulse counter function is configured, the pulse duration after which a valid pulse of the connected contacts is identified is defined for the input via the debounce time.
Minimum signal duration for "0" signals Minutes	<b>0 ... 59</b>	This parameter specifies the time of the minimum signal duration for "0" signals in minutes. The duration resulting from the parameters for minimum signal duration in minutes, seconds and milliseconds yields the total minimum signal duration. When the pulse counter function is configured, the period during which a pulse must be present until a valid pulse is identified is defined for the input via the minimum signal duration.
Minimum signal duration for "0" signals Seconds	<b>0 ... 59</b>	This parameter specifies the time of the minimum signal duration for "0" signals in seconds. The duration resulting from the parameters for minimum signal duration in minutes, seconds and milliseconds yields the total minimum signal duration. When the pulse counter function is configured, the period during which a pulse must be present until a valid pulse is identified is defined for the input via the minimum signal duration.
Minimum signal duration for "0" signals Milliseconds	<b>100 ... 999</b>	This parameter specifies the time of the minimum signal duration for "0" signals in milliseconds. The duration resulting from the parameters for minimum signal duration in minutes, seconds and milliseconds yields the total minimum signal duration. When the pulse counter function is configured, the period during which a pulse must be present until a valid pulse is identified is defined for the input via the minimum signal duration.



Minimum signal duration for "1" signals Minutes	<b>0 ... 59</b>	This parameter specifies the time of the minimum signal duration for "1" signals in minutes. The duration resulting from the parameters for minimum signal duration in minutes, seconds and milliseconds yields the total minimum signal duration. When the pulse counter function is configured, the period during which a pulse must be present until a valid pulse is identified is defined for the input via the minimum signal duration.
Minimum signal duration for "1" signals Seconds	<b>0 ... 59</b>	This parameter specifies the time of the minimum signal duration for "1" signals in seconds. The duration resulting from the parameters for minimum signal duration in minutes, seconds and milliseconds yields the total minimum signal duration. When the pulse counter function is configured, the period during which a pulse must be present until a valid pulse is identified is defined for the input via the minimum signal duration.
Minimum signal duration for "1" signals Milliseconds	<b>100 ... 999</b>	This parameter specifies the time of the minimum signal duration for "1" signals in milliseconds. The duration resulting from the parameters for minimum signal duration in minutes, seconds and milliseconds yields the total minimum signal duration. When the pulse counter function is configured, the period during which a pulse must be present until a valid pulse is identified is defined for the input via the minimum signal duration.
Send counter status after bus voltage return?	<b>Yes</b> <b>No</b>	This parameter defines the behaviour of the device when handling the counter statuses of the main and intermediate counters. When "Yes" is set, the current meter readings after bus voltage returns are automatically sent to the KNX via the communication objects "Main meter reading" and "Intermediate meter reading".
Reset counter status after ETS download?	<b>Yes</b> <b>No</b>	This parameter defines the behaviour of the device when handling the counter statuses of the main and intermediate counters. When "Yes" is set, the current counter statuses are reset if there is an ETS download.

## Pulse counter - main counter

Counting direction	<p><b>Up-counter</b></p> <p>Down-counter</p>	<p>The meter functions as either an up- or down-counter. This parameter defines the counting direction. The counting range is determined via the function of the pulse counter and via the start and end values specified for the main or intermediate counters.</p>
Permit counter status polling via KNX?	<p>Yes</p> <p><b>No</b></p>	<p>With the meter reading polling function, the device offers another possibility to send the counter status to the KNX. In this case, the device only transmits the meter reading if the counter status is polled via communication object. Parameter "Permit counter status polling via KNX?" enables the corresponding communication object. This function can be used in parallel with the automatic transmission.</p>
Behaviour after counter status polled via KNX	<p><b>Meter continues to run</b></p>	<p>The behaviour of the main counter after a counter status polling via KNX is permanently defined. The main counter continues to run after the counter status is polled.</p>
Permit automatic transmission of counter status?	<p><b>Yes</b></p> <p>No</p>	<p>The meter reading is optionally sent when parameter "Permit automatic transmission of meter reading?" is set to "Yes". The criteria for automatic transmission is defined with parameter "Send meter reading", which is visible when "Yes" is set.</p>
"Send meter reading"	<p><b>on change</b></p> <p>cyclical</p> <p>on change and cyclical</p>	<p>This parameter defines the criterion for automatic transmission of the counter status. Additional parameters are displayed depending on this setting.</p>
Send meter reading for value changes of	<p>1 ... <b>100</b> ... 65535 (255, 127, 32767, ...)</p>	<p>If the meter reading should be sent after changes, parameter "Send meter reading for value changes of" defines the exact value by which the meter reading must change for the device to send the correct meter reading again. The value range of this parameter is oriented to the set pulse counter</p>

		function. This parameter is visible when the meter reading is sent "For change" or "For change and cyclical".
Hours	0 ... 23	Cyclical transmission of the counter status can take place in an interval of 10 seconds to 23 hours : 59 minutes : 59 seconds. The device always transmits the meter reading cyclically after the time defined in the parameters has elapsed. The sum resulting from the parameters for minutes, seconds and milliseconds yields the total cycle time. This parameter is visible when the meter reading is sent "Cyclically" or "For change and cyclically".
Minutes	0 ... 5 ... 59	Cyclical transmission of the counter status can take place in an interval of 10 seconds to 23 hours : 59 minutes : 59 seconds. The device always transmits the meter reading cyclically after the time defined in the parameters has elapsed. The sum resulting from the parameters for minutes, seconds and milliseconds yields the total cycle time. This parameter is visible when the meter reading is sent "Cyclically" or "For change and cyclically".
Seconds	10 ... 59	Cyclical transmission of the counter status can take place in an interval of 10 seconds to 23 hours : 59 minutes : 59 seconds. The device always transmits the meter reading cyclically after the time defined in the parameters has elapsed. The sum resulting from the parameters for minutes, seconds and milliseconds yields the total cycle time. This parameter is visible when the meter reading is sent "Cyclically" or "For change and cyclically".
Start value specification	<b>Via parameter</b> Via communication object	Regardless of counting direction, pulse counting begins at the start value and ends at the end value. The start and end values can be specified for the device via parameter or communication object. Depending on this setting, the ETS provides either a parameter or a communication object for specifying the start value. Condition (up-counter): Start value < End value Condition (down-counter): Start value >

		End value
Start value		The value range in which the start/end values lie is oriented to the set pulse counter function. When setting via parameter, the start value of the pulse counting is specified directly with this parameter. In this case, the preset default value is also oriented to the counter's counting direction.
	Up-counter start value (down-counter start value)	The following parameter settings define the possible start values in dependence on the set pulse counter function. The first value range is available when the meter counts up. The value range in parentheses is available when the meter counts down.
	<b>0</b> ... 254 (1 ... <b>255</b> )	The start value can lie within this value range when "Pulse counter 0...255" is set.
	-128 ... <b>0</b> ... 126 (-127 ... <b>127</b> )	The start value can lie within this value range when "Pulse counter -128...127" is set.
	<b>0</b> ... 65534 (1 ... <b>65535</b> )	The start value can lie within this value range when "Pulse counter 0...65535" is set.
	-32768 ... <b>0</b> ... 32766 (-32767 ... <b>32767</b> )	The start value can lie within this value range when "Pulse counter -32768...32767" is set.
	<b>0</b> ... 4294967294 (1 ... <b>4294967295</b> )	The start value can lie within this value range when "Pulse counter 0...4294967295" is set.
	-2147483648 ... <b>0</b> ... 2147483646 (-2147483647 ... <b>2147483647</b> )	The start value can lie within this value range when "Pulse counter -2147483648...2147483647" is set.
End value specification	<b>Via parameter</b>  Via communication object	Regardless of counting direction, pulse counting begins at the start value and ends at the end value. The start and end values can be specified for the device via parameter or communication object. Depending on this setting, the ETS

	provides either a parameter or a communication object for specifying the end value. Condition (up-counter): Start value < End value Condition (down-counter): Start value > End value
End value	The value range in which the start/end values lie is oriented to the set pulse counter function. When setting via parameter, the end value of the pulse counting is specified directly with this parameter. In this case, the preset default value is also oriented to the counter's counting direction.
Up-counter end value (down-counter end value)	The following parameter settings define the possible end values in dependence on the set pulse counter function. The first value range is available when the meter counts up. The value range in parentheses is available when the meter counts down.
1 ... <b>255</b> (0 ... 254)	The start value can lie within this value range when "Pulse counter 0...255" is set.
-127 ... <b>127</b> (-128 ... <b>0</b> ... 126)	The start value can lie within this value range when "Pulse counter -128...127" is set.
1 ... <b>65535</b> (0 ... 65534)	The start value can lie within this value range when "Pulse counter 0...65535" is set.
-32767 ... <b>32767</b> (-32768 ... <b>0</b> ... 32766)	The start value can lie within this value range when "Pulse counter -32768...32767" is set.
1 ... <b>4294967295</b> (0 ... 4294967294)	The start value can lie within this value range when "Pulse counter 0...4294967295" is set.
-2147483647 ... <b>2147483647</b> (-2147483648 ... <b>0</b> ... 2147483646)	The start value can lie within this value range when "Pulse counter -2147483648...2147483647" is set.

Behaviour after counter has elapsed	<b>Meter is reset and restarted</b>	Parameter "Behaviour after meter elapses" is permanently set to "Meter is reset and restarted". Correspondingly, the main counter is reset and restarted after the counter has elapsed. In the same way, the configured "Behaviour after meter has elapsed" defines the behaviour of the meter when the end value received via the communication object is greater or less than (depending on the counting direction) the current meter reading.
Report elapsed counter to KNX?	Yes <b>No</b>	Optionally, an elapsed counter can be reported with a KNX telegram via the communication object "... Elapsed counter report". This communication object is available when parameter "Report elapsed counter to KNX?" is set to "Yes".
Permit counter reset via KNX?	Yes <b>No</b>	The counter reset via KNX can be set separately for the main and "... intermediate counters of each input via the communication object "...Reset meter reading" when parameter "Permit counter reset via KNX?" is set to "Yes". During a counter reset, the meter reading is reset to the start value and the counter is restarted.
Disable counter reset via KNX?	Yes <b>No</b>	The function of the communication object "... Reset meter reading" can be disabled. The communication object which temporarily disables the possibility to reset a counter is enabled when parameter "Disable counter reset via KNX" is set to "Yes".
Polarity of disabling object	Disable = 0 (Enable =1) <b>Disable = 1 (Enable =0)</b>	The polarity of the disabling object can be set with this parameter.
<b>Pulse counter - intermediate counter</b>		
Counting direction	<b>Up-counter</b> Down-counter	The meter functions as either an up- or down-counter. This parameter defines the counting direction. The counting range is determined via the function of the pulse counter and via the start and end values specified for the main or intermediate counters.

Permit counter status polling via KNX?	<p>Yes</p> <p><b>No</b></p>	<p>With the meter reading polling function, the device offers another possibility to send the counter status to the KNX. In this case, the device only transmits the meter reading if the counter status is polled via communication object. Parameter "Permit counter status polling via KNX?" enables the corresponding communication object. This function can be used in parallel with the automatic transmission.</p>
Behaviour of the intermediate counter after counter status polled via KNX	<p><b>Meter continues to run</b></p> <p>Meter is reset and restarted</p>	<p>The behaviour of the intermediate counter after counter status polled via KNX can be defined. After a counter status polling, the intermediate counter can either continue to run or be reset and restarted. The device transmits the meter reading status before the meter reading is reset and the meter restarted.</p>
Permit automatic transmission of counter status?	<p><b>Yes</b></p> <p>No</p>	<p>The meter reading is optionally sent when parameter "Permit automatic transmission of meter reading?" is set to "Yes". The criteria for automatic transmission is defined with parameter "Send meter reading", which is visible when "Yes" is set.</p>
"Send meter reading"	<p><b>on change</b></p> <p>cyclical</p> <p>on change and cyclical</p> <p>Cyclical with subsequent counter reset</p>	<p>This parameter defines the criterion for automatic transmission of the counter status. Additional parameters are displayed depending on this setting.</p>
Send meter reading for value changes of	<p>1 ... <b>100</b> ... 65535 (255, 127, 32767, ...)</p>	<p>If the meter reading should be sent after changes, parameter "Send meter reading for value changes of" defines the exact value by which the meter reading must change for the device to send the correct meter reading again. The value range of this parameter is oriented to the set pulse counter function.</p> <p>This parameter is visible when the meter reading is sent "For change" or "For change and cyclical".</p>

Hours

	<b>0 ... 23</b>	Cyclical transmission of the counter status can take place in an interval of 10 seconds to 23 hours : 59 minutes : 59 seconds. The device always transmits the meter reading cyclically after the time defined in the parameters has elapsed. The sum resulting from the parameters for minutes, seconds and milliseconds yields the total cycle time. This parameter is visible when the meter reading is sent "Cyclically" or "For change and cyclically" or "Cyclically with subsequent counter reset".
Minutes	<b>0 ... 5 ... 59</b>	Cyclical transmission of the counter status can take place in an interval of 10 seconds to 23 hours : 59 minutes : 59 seconds. The device always transmits the meter reading cyclically after the time defined in the parameters has elapsed. The sum resulting from the parameters for minutes, seconds and milliseconds yields the total cycle time. This parameter is visible when the meter reading is sent "Cyclically" or "For change and cyclically" or "Cyclically with subsequent counter reset".
Seconds	<b>10 ... 59</b>	Cyclical transmission of the counter status can take place in an interval of 10 seconds to 23 hours : 59 minutes : 59 seconds. The device always transmits the meter reading cyclically after the time defined in the parameters has elapsed. The sum resulting from the parameters for minutes, seconds and milliseconds yields the total cycle time. This parameter is visible when the meter reading is sent "Cyclically" or "For change and cyclically" or "Cyclically with subsequent counter reset".
Start value specification	<b>Via parameter</b> Via communication object	Regardless of counting direction, pulse counting begins at the start value and ends at the end value. The start and end values can be specified for the device via parameter or communication object. Depending on this setting, the ETS provides either a parameter or a communication object for specifying the start value. Condition (up-counter): Start value < End value Condition (down-counter): Start value > End value



Start value		The value range in which the start/end values lie is oriented to the set pulse counter function. When setting via parameter, the start value of the pulse counting is specified directly with this parameter. In this case, the preset default value is also oriented to the counter's counting direction.
	Up-counter start value (down-counter start value)	The following parameter settings define the possible start values in dependence on the set pulse counter function. The first value range is available when the meter counts up. The value range in parentheses is available when the meter counts down.
	<b>0 ... 254</b> (1 ... <b>255</b> )	The start value can lie within this value range when "Pulse counter 0...255" is set.
	-128 ... <b>0</b> ... 126 (-127 ... <b>127</b> )	The start value can lie within this value range when "Pulse counter -128...127" is set.
	<b>0 ... 65534</b> (1 ... <b>65535</b> )	The start value can lie within this value range when "Pulse counter 0...65535" is set.
	-32768 ... <b>0</b> ... 32766 (-32767 ... <b>32767</b> )	The start value can lie within this value range when "Pulse counter -32768...32767" is set.
	<b>0 ... 4294967294</b> (1 ... <b>4294967295</b> )	The start value can lie within this value range when "Pulse counter 0...4294967295" is set.
	-2147483648 ... <b>0</b> ... 2147483646 (-2147483647 ... <b>2147483647</b> )	The start value can lie within this value range when "Pulse counter -2147483648...2147483647" is set.
End value specification	<b>Via parameter</b>  Via communication object	Regardless of counting direction, pulse counting begins at the start value and ends at the end value. The start and end values can be specified for the device via parameter or communication object. Depending on this setting, the ETS provides either a parameter or a communication object for specifying the end value. Condition (up-counter): Start value <

		End value Condition (down-counter): Start value > End value
End value		The value range in which the start/end values lie is oriented to the set pulse counter function. When setting via parameter, the end value of the pulse counting is specified directly with this parameter. In this case, the preset default value is also oriented to the counter's counting direction.
	Up-counter end value (down-counter end value)	The following parameter settings define the possible end values in dependence on the set pulse counter function. The first value range is available when the meter counts up. The value range in parentheses is available when the meter counts down.
	1 ... <b>255</b> (0 ... 254)	The start value can lie within this value range when "Pulse counter 0...255" is set.
	-127 ... <b>127</b> (-128 ... <b>0</b> ... 126)	The start value can lie within this value range when "Pulse counter -128...127" is set.
	1 ... <b>65535</b> (0 ... 65534)	The start value can lie within this value range when "Pulse counter 0...65535" is set.
	-32767 ... <b>32767</b> (-32768 ... <b>0</b> ... 32766)	The start value can lie within this value range when "Pulse counter -32768...32767" is set.
	1 ... <b>4294967295</b> (0 ... 4294967294)	The start value can lie within this value range when "Pulse counter 0...4294967295" is set.
	-2147483647 ... <b>2147483647</b> (-2147483648 ... <b>0</b> ... 2147483646)	The start value can lie within this value range when "Pulse counter -2147483648...2147483647" is set.
Behaviour after counter has elapsed	<b>Meter remains elapsed (reset required)</b>  Meter is reset and restarted	This parameter defines whether the intermediate counter is reset and restarted after it elapses or if it stays elapsed.

		<p>When "Intermediate meter is reset and restarted" is set, the meter counts until the defined end value. Once this end value is reached, the meter reading is reset and the meter begins counting pulses from the defined start value again.</p> <p>When "Intermediate counter stays elapsed" is set, the intermediate meter counts until the defined end value. Once this end value is reached, the intermediate counter stops counting. The intermediate counter must be reset before it can start counting pulses from the defined start value again. Parameter "Permit counter reset via KNX?" is permanently set to "Yes" when "Meter stays elapsed" is set.</p> <p>In the same way, the configured "Behaviour after meter has elapsed" defines the behaviour of the meter when the end value received via the communication object is greater or less than (depending on the counting direction) the current meter reading.</p>
Report elapsed counter to KNX?	<p>Yes</p> <p><b>No</b></p>	<p>Optionally, an elapsed counter can be reported with a KNX telegram via the communication object "... Elapsed counter report". This communication object is available when parameter "Report elapsed counter to KNX?" is set to "Yes".</p>
Permit counter reset via KNX?	<p>Yes</p> <p><b>No</b></p>	<p>The counter reset via KNX can be set separately for the main and "... intermediate counters of each input via the communication object "...Reset meter reading" when parameter "Permit counter reset via KNX?" is set to "Yes". During a counter reset, the meter reading is reset to the start value and the counter is restarted.</p>
Disable counter reset via KNX?	<p>Yes</p> <p><b>No</b></p>	<p>The function of the communication object "... Reset meter reading" can be disabled. The communication object which temporarily disables the possibility to reset a counter is enabled when parameter "Disable counter reset via KNX" is set to "Yes".</p>
Polarity of disabling object	<p>Disable = 0 (Enable =1)</p> <p><b>Disable = 1 (Enable =0)</b></p>	<p>The polarity of the disabling object can be set with this parameter.</p>



## 4.2.5.2.6 Parameter "Cyclical transmission"

Description	Values	Comment
<p><input type="checkbox"/> E1 - Transmit cyclically (only for "Switching" function)</p> <p>Cyclical transmission ?</p>		<p>Optionally, the object values can be transmitted cyclically to the bus for the "Switching" function. For this, the transmission criteria must first be defined in the ETS. This parameter specifies with which value cyclical transmission should take place. The object value entered in the switching objects by the device on a edge change or externally by the bus is always transmitted cyclically. The object value is then also transmitted cyclically when "no reaction" is assigned to a rising or falling edge. Cyclical transmission also takes place directly after bus voltage return, if the reaction after bus voltage return corresponds to the transmission criterion for cyclical transmission. During an active disable, no cyclical transmissions take place via the disabled input.</p>
	<b>no cyclical transmission</b>	There is no cyclical transmission.
	Repeat on ON	Transmission takes place cyclically when the object value is "ON".
	Repeat on OFF	Transmission takes place cyclically when the object value is "OFF".
	Repeat on ON and OFF	Transmission takes place cyclically irrespective of the object value.
Cyclical transmission Switching object 1.1 ?	<b>Yes</b> <b>No</b>	Here, it is possible to specify whether cyclical transmission should take place via the first switching object of the input.
Time for cyclical transmission Hours (0...23)	<b>0...23</b>	If cyclical transmission should take place via the first switching object of the input, then the cycle time can be configured here. Setting the cycle time hours.
Minutes (0...59)	<b>0...59</b>	Setting the cycle time minutes.
Seconds (0...59)	<b>0...30...59</b>	Setting the cycle time seconds.
Cyclical transmission Switching object 1.2 ?	<b>Yes</b> <b>No</b>	Here, it is possible to specify whether cyclical transmission should take place via the second switching object of the input.
	<b>0...23</b>	

Time for cyclical  
transmission  
Hours (0...23)

If cyclical transmission should take place via the second switching object of the input, then the cycle time can be configured here.  
Setting the cycle time hours.

Minutes (0...59)

**0**...59

Setting the cycle time minutes.

Seconds (0...59)

0...**30**...59

Setting the cycle time seconds.

## 4.2.5.2.7 "Disable" parameters

Description	Values	Comment
□↵ E1 - Disabling		

The following parameters are only visible for the function "Switching"...

Disabling		<p>This parameter is only available for the function "switching" and "dimming". A specific reaction can be executed independently for each input at the beginning and end of a disable. In so doing, it is possible to configure to "No reaction". Only in this case are dimming or venetian blind control operations or value adjustments completed during an active disable. In all other cases, the configured command is transmitted instantly at the beginning of the disable. Furthermore, edges or signals on the corresponding inputs are not evaluated during an active disable!</p> <p>Updates on disabling objects (disable or enable) cause the transmission every time of the corresponding configured command "at the beginning or end of the disable".</p> <p>During an active disable, no cyclical transmissions take place via the disabled input.</p> <p>If a cyclical transmission took place prior to activating the disabling function, no cyclical transmission will take place any more at the end of the disable in the parameterisation "no reaction". In this case, the object value is first transmitted cyclically again after an update on the switching object. In all other cases, the object value is transmitted cyclically again after the end of the disable.</p>
Disabling function switching object 1.1	<b>Disabled</b> enabled	<p>The inputs can be separately disabled via the bus using 1-bit objects. With the "Switching" function, it is possible to disable the two switching objects of an input independently of each other. With an active disabling function, signal edges at the input are ignored by the device related to the affected objects. This parameter enables the disabling function of the first communication object.</p>
Polarity of the disabling object	<b>Disable = 1 (Enable = 0)</b> Disable = 0 (Enable = 1)	<p>This parameter defines the polarity of the disabling object.</p>
Behaviour at the beginning of the	<b>No reaction</b> ON	<p>With an active disable, the first switching object is disabled. This parameter specifies the command transmitted via</p>

<p>disabling function Switching object 1.1</p>	<p>OFF TOGGLE</p>	<p>this object at the beginning of the disabling. "TOGGLE" switches over the current object value.</p>
<p>Behaviour at the end of the disabling function Switching object 1.1</p>	<p><b>No reaction</b> ON OFF Transmit current input status</p>	<p>With an active disable, the first switching object is disabled. This parameter specifies the command transmitted via this object at the end of the disabling. "TOGGLE" switches over the current object value. In the "Transmit current input status" setting, the device evaluates the current static signal status of the input and, according to this, transmits the appropriately configured telegram to the bus (contact closed at the input = telegram as with rising edge; contact open at input = telegram as with falling edge).</p>
<p>Disabling function switching object 1.2</p>	<p><b>Disabled</b> enabled</p>	<p>The inputs can be separately disabled via the bus using 1-bit objects. With the "Switching" function, it is possible to disable the two switching objects of an input independently of each other. With an active disabling function, signal edges at the input are ignored by the device related to the affected objects. This parameter enables the disabling function of the second communication object.</p>
<p>Polarity of the disabling object</p>	<p><b>Disable = 1 (Enable = 0)</b> Disable = 0 (Enable = 1)</p>	<p>This parameter defines the polarity of the disabling object.</p>
<p>Behaviour at the beginning of the disabling function Switching object 1.2</p>	<p><b>No reaction</b> ON OFF TOGGLE</p>	<p>With an active disable, the second switching object is disabled. This parameter specifies the command transmitted via this object at the beginning of the disabling. "TOGGLE" switches over the current object value.</p>
<p>Behaviour at the end of the disabling function Switching object 1.2</p>	<p><b>No reaction</b> ON OFF Transmit current input status</p>	<p>With an active disable, the second switching object is disabled. This parameter specifies the command transmitted via this object at the end of the disabling. "TOGGLE" switches over the current object value. In the "Transmit current input status" setting, the device evaluates the current static signal status of the input and, according to this, transmits the appropriately configured telegram to the bus (contact closed at the input = telegram as with rising edge; contact open at input = telegram as with falling edge).</p>



falling edge).

The following parameters are only visible for the function "Dimming"...

Disabling function	<b>Disabled</b> enabled	The inputs can be separately disabled via the bus using 1-bit objects. With an active disabling function, signal edges at the input are ignored by the device related to the affected objects. This parameter enables the disabling function of the input.
Polarity of the disabling object	<b>Disable = 1 (Enable = 0)</b> Disable = 0 (Enable = 1)	This parameter defines the polarity of the disabling object.
Behaviour at the beginning of the disabling function	<b>No reaction</b> ON OFF TOGGLE	With an active disable, the input is disabled. This parameter specifies the command transmitted via the "Switching" object at the beginning of the disabling. "TOGGLE" switches over the current object value.
Behaviour at the end of the disabling function	<b>No reaction</b> OFF	With an active disable, the input is disabled. This parameter specifies the command transmitted via the "Switching" object at the end of the disabling.

The following parameters are only visible for the function "Venetian Blind"...

Disabling function	<b>Disabled</b> enabled	The inputs can be separately disabled via the bus using 1-bit objects. With an active disabling function, signal edges at the input are ignored by the device related to the affected objects. This parameter enables the disabling function of the input.
Polarity of the disabling object	<b>Disable = 1 (Enable = 0)</b> Disable = 0 (Enable = 1)	This parameter defines the polarity of the disabling object.
Behaviour at the beginning of the disabling function	<b>No reaction</b> up Down Toggle	With an active disable, the input is disabled. This parameter specifies the command transmitted via the "Long time operation" object at the beginning of the disabling. "TOGGLE" switches over the current object value.

Behaviour at the end of the disabling function	<b>No reaction</b> up Down Toggle	With an active disable, the input is disabled. This parameter specifies the command transmitted via the "Long time operation" object at the end of the disabling. "TOGGLE" switches over the current object value.
--	--	--

The following parameters are only visible for the function "Value transmitter"...

Disabling function	<b>Disabled</b> enabled	The inputs can be separately disabled via the bus using 1-bit objects. With an active disabling function, signal edges at the input are ignored by the device related to the affected objects. This parameter enables the disabling function of the input.
--------------------	----------------------------	--

Polarity of the disabling object	<b>Disable = 1 (Enable = 0)</b> Disable = 0 (Enable = 1)	This parameter defines the polarity of the disabling object.
----------------------------------	---	--

Behaviour at the beginning of the disabling function	<b>No reaction</b> Reaction as rising edge Reaction as falling edge Transmit current input status	With an active disable, the input is disabled. This parameter specifies the command transmitted via the value object at the beginning of the disabling. In the "Transmit current input status" setting, the device evaluates the static signal status of the input and, according to this, transmits the appropriately configured telegram to the bus (contact closed at the input = telegram as with rising edge; contact open at input = telegram as with falling edge). The selection of the settings of this parameter depends on the configured edge evaluation of the input.
--	--	--

Behaviour at the end of the disabling function	<b>No reaction</b> Reaction as rising edge Reaction as falling edge Transmit current input status	With an active disable, the input is disabled. This parameter specifies the command transmitted via the value object at the end of the disabling. In the "Transmit current input status" setting, the device evaluates the static signal status of the input and, according to this, transmits the appropriately configured telegram to the bus (contact closed at the input = telegram as with rising edge; contact open at input = telegram as with falling edge). The selection of the settings of this parameter depends on the configured edge evaluation of the input.
--	--	--

☐ Inputs 2...6 see input 1!

## 5 Appendix

### 5.1 Index

<b>A</b>	
application program.....	15
<b>B</b>	
bus voltage return.....	40
<b>C</b>	
Commissioning with the ETS.....	10
communication objects.....	16
<b>D</b>	
Debounce time.....	40
Debounce time (pulse counter).....	51
Dimming.....	42
disabling function.....	57
<b>E</b>	
ETS programming operation.....	40
ETS search paths.....	12
<b>I</b>	
Intermediate counter.....	53
<b>M</b>	
Main counter.....	53
Minimum signal duration (pulse counter)	51
<b>P</b>	
Pulse counter.....	48
<b>S</b>	
signal evaluation.....	37
Signal types.....	37
state as delivered.....	58
Switching.....	41
<b>T</b>	
Telegram rate limit.....	40
<b>U</b>	
Unloading the application program.....	15
<b>V</b>	
Value transmitter.....	45
Venetian blind.....	43

**ALBRECHT JUNG GMBH & CO. KG**

Volmestraße 1  
58579 Schalksmühle  
GERMANY

Telefon: +49 2355 806-0  
Telefax: +49 2355 806-204  
kundencenter@jung.de  
www.jung.de