

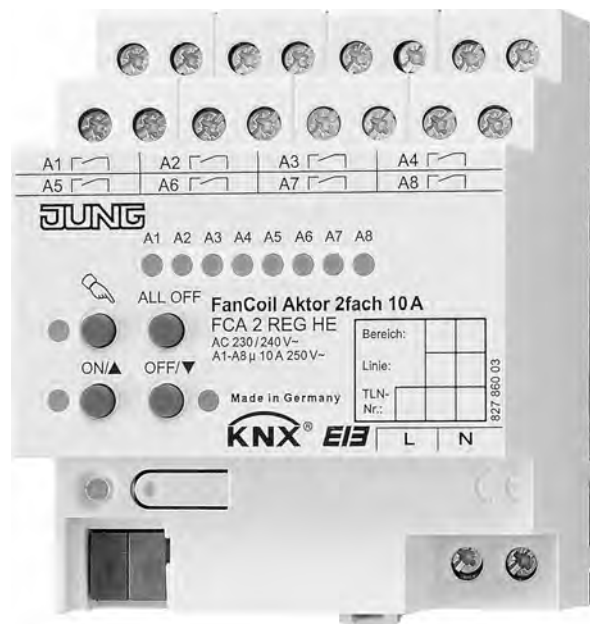

Product documentation

Fan coil actuator 2-gang
Art.-No.: FCA 2 REGHE



ALBRECHT JUNG GMBH & CO. KG
Volmestraße 1
D-58579 Schalksmühle

Telefon: +49.23 55.8 06-0
Telefax: +49.23 55.8 06-1 89
E-mail: mail.info@jung.de
Internet: www.jung.de
www.jung-katalog.de

Issue: 08.03.2011
63870x20

Contents

1	<u>Product definition</u>	<u>3</u>
1.1	Product catalogue	3
1.2	Purpose	3
2	<u>Fitting, electrical connection and operation</u>	<u>4</u>
2.1	Safety instructions	4
2.2	Device components	5
2.3	Fitting and electrical connection	6
2.4	Commissioning	11
2.5	Operation	12
3	<u>Technical data</u>	<u>20</u>
4	<u>Software description</u>	<u>22</u>
4.1	Software specification	22
4.2	Software "Switching fan coil 20B0x1"	23
4.2.1	Scope of functions	23
4.2.2	Notes on the software	25
4.2.3	Object table	26
4.2.4	Functional description	32
4.2.4.1	Application basics	32
4.2.4.2	Description of channel-independent functions	36
4.2.4.2.1	Fan coil channels, the term "fan coil system" and valve functions	36
4.2.4.2.2	Delay after bus voltage return	46
4.2.4.2.3	Manual control	47
4.2.4.3	Channel-oriented functional description	52
4.2.4.3.1	Reset and initialisation behaviour	52
4.2.4.3.2	Protection functions	56
4.2.4.3.3	Basic configuration of the fan levels	59
4.2.4.3.4	Defining the behaviour of the fan levels	66
4.2.4.3.5	Feedback telegrams	78
4.2.4.3.6	Manual fan control	83
4.2.4.3.7	Cyclical command value monitoring	90
4.2.4.3.8	Disabling function	94
4.2.4.4	Priorities	98
4.2.4.5	Summary of the output assignments	99
4.2.4.6	State as supplied	101
4.2.5	Parameter	102
5	<u>Appendix</u>	<u>125</u>
5.1	Index	125

1 Product definition

1.1 Product catalogue

Product name: Fan coil actuator 2-gang 10A SE

Use: Actuator

Design: REG (Rail-mounted device)

Art.-No.: FCA 2 REGHE

1.2 Purpose

The fan coil actuator permits the electrical control of one or two fan coil units. Fan coil units are used for requirements-oriented heating or cooling of rooms, and can be installed just like conventional radiators anywhere that a central heating and/or cooling system is installed. With these devices, air circulation is supported by a blower. This uses low-noise fans to move the room air past the heat exchangers. The blower output can be controlled using in most cases up to 6 speed levels.

Depending on the design of the device, fan coil units are used in 2-pipe systems (heating only, cooling only, or heating and cooling via a common piping system) or alternatively in 4-pipe systems (heating and cooling via separate pipes). The fan coil actuator supports both of these piping principles.

The fan coil actuator generally receives command value telegrams, for example from room thermostats, and converts these command value specifications into the equivalent fan levels. In addition, the fan coil actuator controls the valves in the fan coil unit, either by means of an operating mode specification or alternatively directly via separate command value specifications; the valves then open or close the heating or cooling line(s) in accordance with requirements.

The fan coil actuator also allows manual activation of the blower fan, thus enabling purely ventilation functions without heating or cooling, or individual room ventilation with heating or cooling active. This function is attractive for hotel rooms or classroom and office spaces. This can be controlled manually via push-buttons or operating panels.

The operating elements (4 push-buttons) on the front of the device can be used to switch relay of the actuator on and off manually in parallel with the KNX / EIB, even without bus voltage, or in the unprogrammed state. This enables quick function checks of the connected valves and fans.

Moreover, the preferred states of the relays in case of bus voltage failure or bus/mains voltage returning can be preset separately. For configuration and commissioning of this device it is recommended to use ETS3.0d. The advantages with regard to downloading (shorter loading times) and parameter configuration are available only if this new ETS patch version or later versions are used. For ETS2 and older versions of ETS3, a separate product database is available.

The fan coil actuator has its own power supply provided by a mains voltage connection that is independent of the connected load. For activation of the outputs the 230 V mains voltage must always be switched on. The power supply for the device electronics (BCU with application program) is drawn from the bus voltage or from the mains voltage.

The device is designed for mounting on DIN rails in closed compact boxes or in power distributors in fixed installations in dry rooms.

2 Fitting, electrical connection and operation

2.1 Safety instructions

Electrical equipment may only be installed and fitted by electrically skilled persons. The applicable accident prevention regulations must be observed.

Failure to observe the instructions may cause damage to the device and result in fire and other hazards.

Before working on the device or exchanging the connected loads, disconnect it from the power supply (switch off the miniature circuit breaker), otherwise there is the risk of an electric shock.

The shutter actuator is not suited for safe disconnection of the mains.

Do not connect any loads for SELV/PELV.

Do not connect any three-phase motors.

Make sure during the installation that there is always sufficient insulation between the mains voltage and the bus. A minimum distance of at least 4 mm must be maintained between bus conductors and mains voltage cores.

The device may not be opened or operated outside the technical specifications.

2.2 Device components

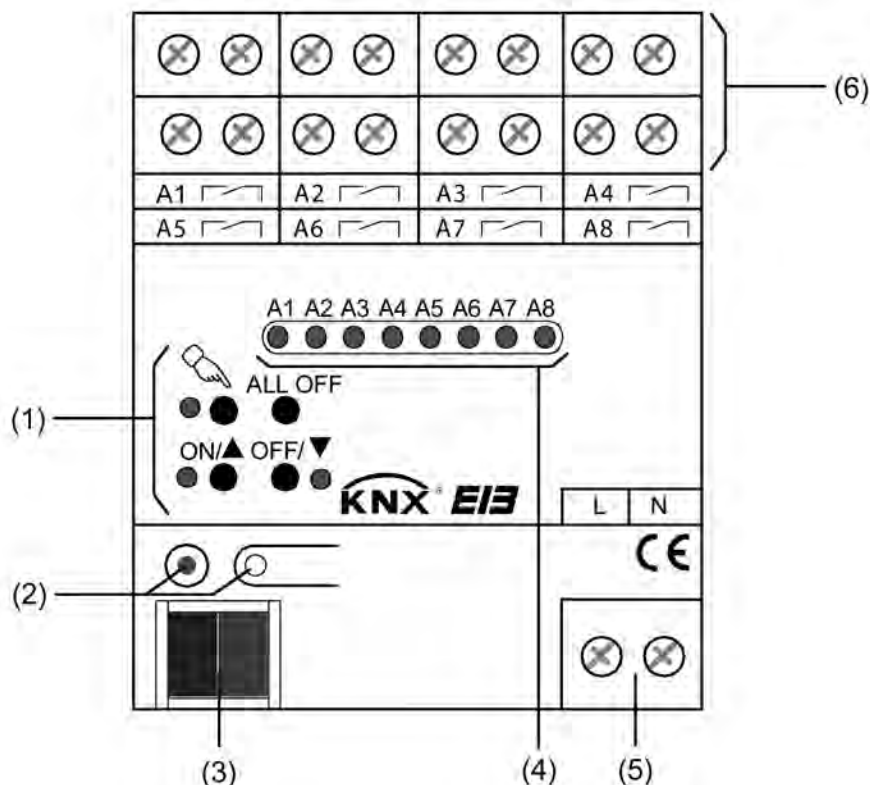

Figure 1: Device components

- (1) Button field for manual control with status LEDs
- (2) Programming button and programming LED (red). The programming LED flashes slowly when the safe-state mode is active.
- (3) KNX/EIB bus connection
- (4) Status LEDs (red) for the outputs with switching state indication (1 LED per output):
 - LED off: output switched off
 - LED on: output switched on
 - LED flashing slowly: output in manual control
 - LED flashing quickly: output disabled via manual control
- (5) Mains voltage terminal for power supply to the device electronics
- (6) Screw terminals (Ax, ⎓) for connection of the valves or fans of a fan coil unit. It is also possible to employ unused fan level outputs as simple switching outputs. The assignment and function of the individual outputs is software-dependent (see software description).

Dimensions of shutter actuator 2/4-channel REG:

Width (W): 72 mm (4 modules) / height (H): 90 mm / depth (D): 70 mm

2.3 Fitting and electrical connection

**DANGER!**

Electrical shock when live parts are touched.

Electrical shocks can be fatal.

Before working on the device, disconnect the power supply and cover up live parts in the working environment.

**DANGER!**

Electrical shock on all SELV/PELV circuits when loads for mains voltage and SELV/PELV are both connected to an actuator.

Electrical shocks can be fatal. Danger of destruction of all devices connected to the SELV/PELV.

Do not connect any loads for SELV/PELV/FELV!



**CAUTION!**

Incorrect control of the load in case of incorrect device configuration in the ETS!

Danger of destruction of the connected fan coil units.

Adapt the device configuration (output assignment) in the ETS to the connected load! When commissioning the actuator, switch the mains voltage supply for the loads on only after the ETS commissioning has been performed!

Fitting

- Snap onto top hat rail to DIN EN 60715. The output terminals should be up.
-  A KNX/EIB data rail is not required.
-  Observe the ambient temperature range (-5 °C ... +45 °C) and ensure sufficient cooling, if necessary.

Connecting the power supply for the device electronics

- The bus connection (standard bus terminal) and the connection for the mains voltage supply should be carried out according to the following connecting diagram (figure 2).

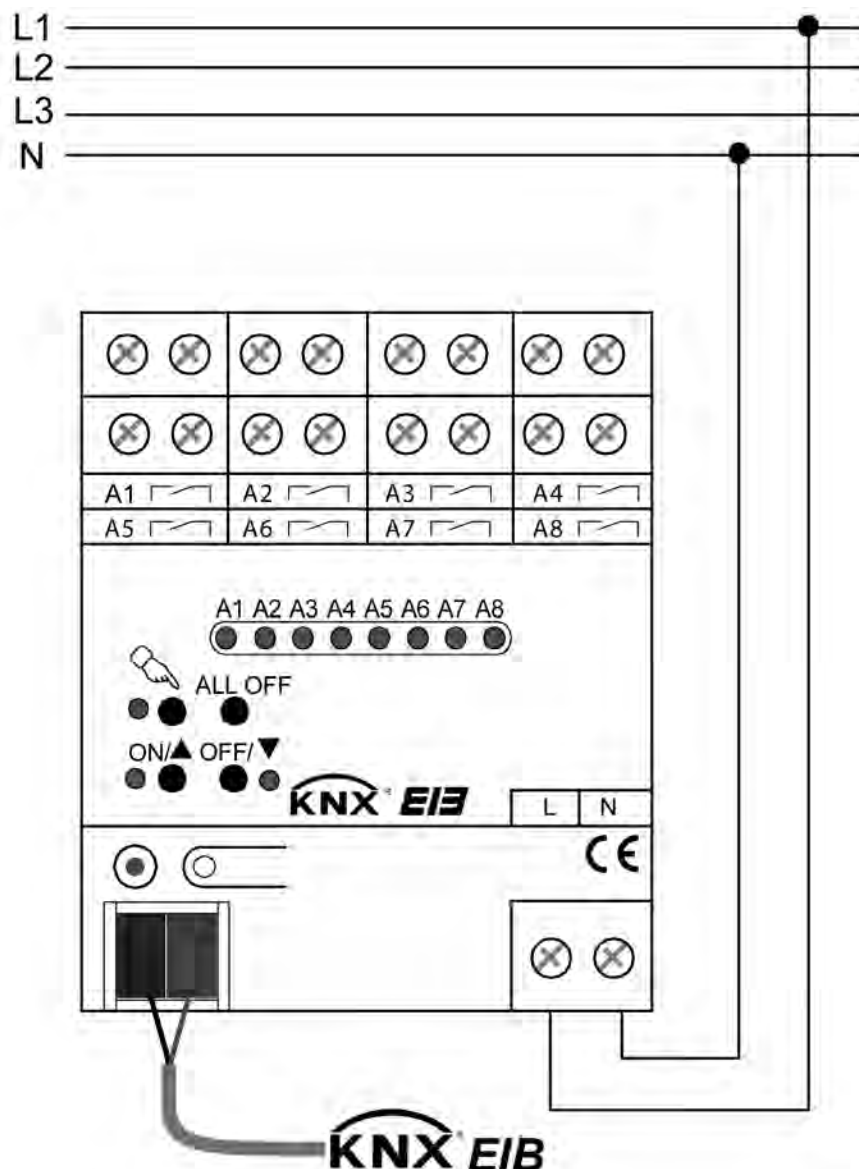

Figure 2: Electrical connection of mains voltage

- i** Any desired phase conductors (L1, L2, L3) can be connected to the neutral conductor (N) at the mains voltage connection (L).
- i** To control the outputs - even via manual control - the mains voltage supply must always be switched on. The power supply for the device electronics (BCU with application program) is drawn from the bus voltage or from the mains voltage.
- i** Connection of the loads (valve, fan) will be described in the following pages.

Connecting the device for valve & fan levels and simple switching outputs

The actuator can be used to control one or two fan coil devices by configuring one-channel or alternatively two-channel operation in the ETS. With only one channel the outputs A1 to max. A8 form the valve and fan level outputs. As soon as two channels are set, the outputs A1 to max. A3 form channel 1 and outputs A4 to max. A8 form channel 2.

The number of possible fan levels is thus limited by the specified number of the fan coil channels. Furthermore, the possible number of valve outputs for heating or cooling is dependent on the fan coil system selected in the ETS (2-pipe or 4-pipe).

Also, fan levels of a fan coil channel which are not used can optionally be used as switching outputs with a simple switching function.

The following connection example (figure 3) shows the connection of a fan coil unit (A.) in 1-channel operation with a 4-pipe fan coil system (heating and cooling via separate valves) and with 3 fan levels.

In the example, output 8, which is not used as a fan level, is wired as a simple switching output (B.). Outputs 6 and 7 are thus unused in this connection example.

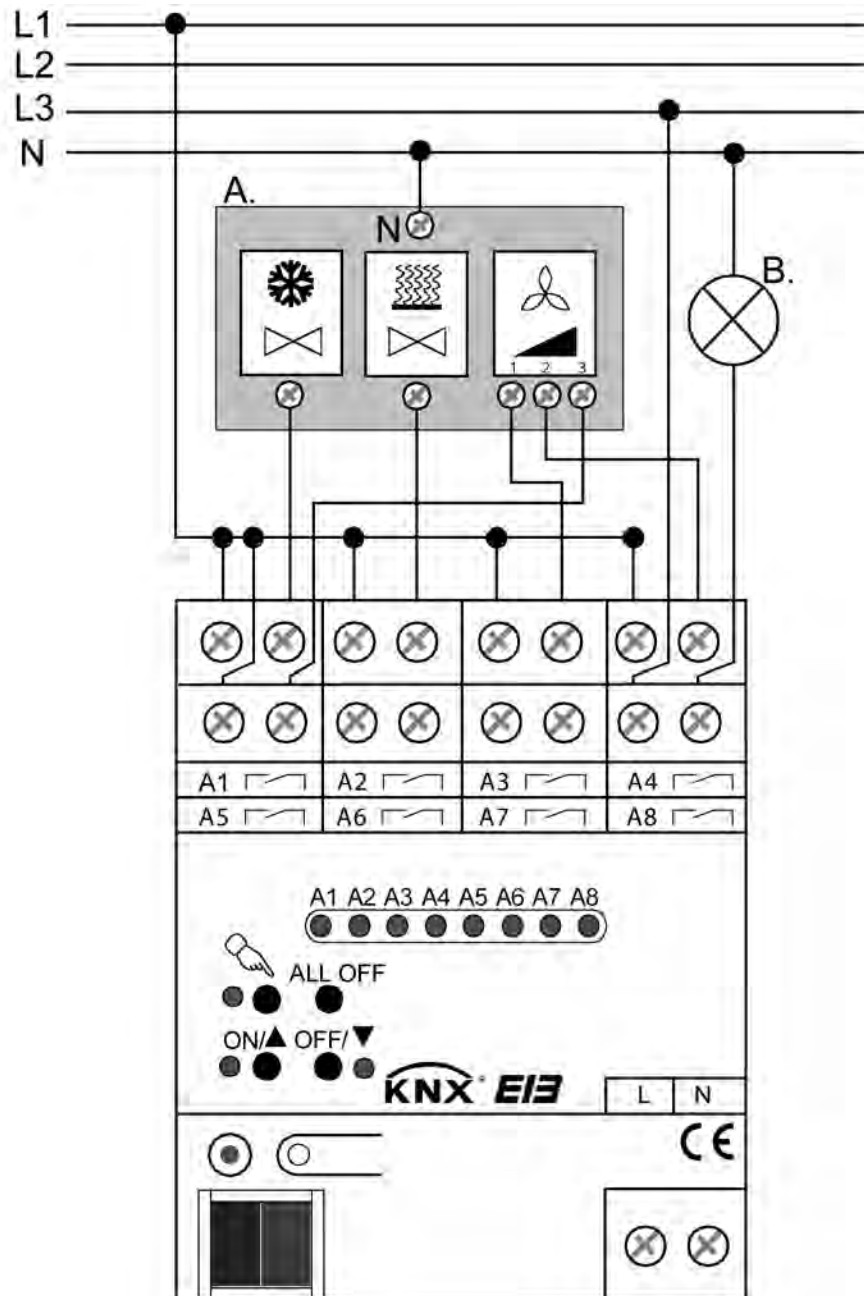

Figure 3: Electrical connection for fan coil unit (A.) in 1-channel operation with additional simple switching load (B.) (connection example)

The following connection example (figure 4) shows the connection of a fan coil unit in 2-channel operation with a 2-pipe fan coil system (heating and cooling via a common valve) and with 3 fan levels each.

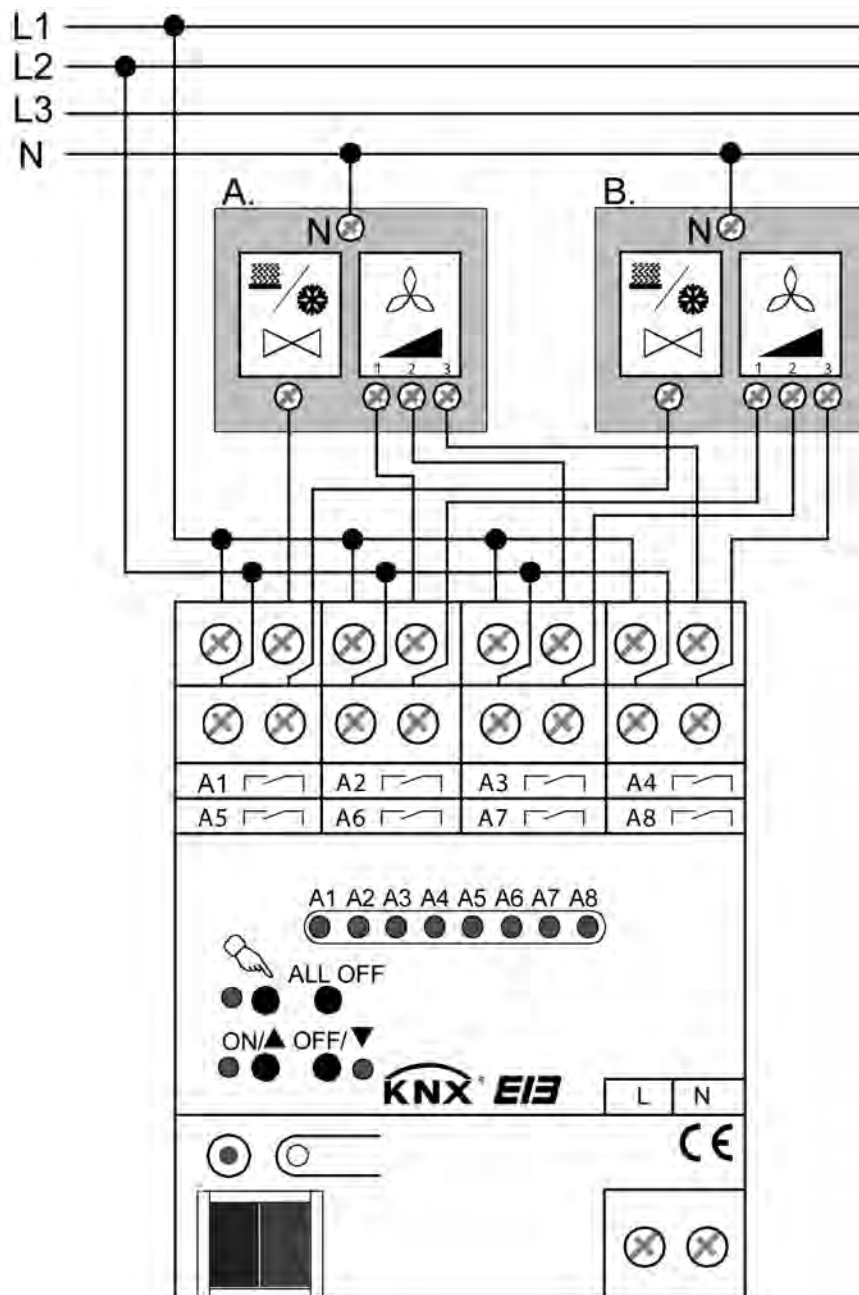

Figure 4: Electrical connection for fan coil units (A. + B.) in 2-channel operation (connection example)

- i** Observe the admissible load ratings (see "Technical data"). Observe instructions of the fan coil unit manufacturers!
- i** Any desired phase conductors (L1, L2, L3) can be connected to the various outputs.
- i** In the state of the fan coil actuator as supplied the outputs are configured as follows (1-channel operation / 4-pipe fan coil system):
 A1: valve output for cooling,
 A2: valve output for heating,
 A3...8: fan level outputs.
- i** In the ETS parameter view, the parameter page "Connection help for output assignment" shows the functions of the up to 8 outputs in accordance with the parameter settings.

Installing / removing the protective cap

To protect the bus lines against hazardous voltages, especially in the area of the connecting terminals, a protective cap can be installed.

The cap is installed with the bus terminal in place and the connected bus line led out at the rear.

- Installing the protective cap (A): Push the protective cap over the bus terminal (see Figure 5) until you feel it engage.
- Removing the protective cap (B): Remove the protective cap by pressing it slightly to the side and pulling it forward and off.



Figure 5: Installing / removing the protective cap

2.4 Commissioning

After installation of the actuator and connection of the bus line, the mains supply and of all electrical loads, the device can be put into operation. The following procedure is generally recommended...

Commissioning with the ETS

**DANGER!**

Electrical shock when live parts are touched.

Electrical shocks can be fatal.

Before working on the device, disconnect the power supply and cover up live parts in the working environment.

**CAUTION!**

Incorrect control of the load in case of incorrect device configuration in the ETS!

Danger of destruction of the connected fan coil units.

Adapt the device configuration (output assignment) in the ETS to the connected load! When commissioning the actuator, switch the mains voltage supply for the loads on only after the ETS commissioning has been performed!

The commissioning of the fan coil actuator is essentially confined to the programming of the actuator via the ETS. To avoid malfunctions, the ETS commissioning must be carried out before the mains voltage supply of the connected loads is switched on. The programming of the actuator via the ETS is possible so long as only the bus voltage is switched on.

Before the ETS commissioning, the parameters of the fan coil actuator must be adapted in the ETS to the specific application and to the output assignments. It must be ensured that the output assignments configured in the ETS are the same as the device connection.

- Switch of mains power supplies of the connected loads (fan coil units, simple switching loads).
 - Switch on bus voltage.
Check: When the programming button is pressed, the red programming LED must light up. Switching on the bus voltage causes the actuator carry out the "Behaviour after bus or mains voltage return" configured in the ETS. In the state of the fan coil actuator as supplied, this behaviour is defined as "Switch off" for all channels.
 - Download the physical address and the application data with the ETS.
 - Switch on mains voltage supply of the actuator (if this has not been done yet) and supply of the connected loads.
- i** When the mains supply of the actuator is on, the outputs of the actuator can be switched manually even if there is no bus voltage or if the actuator is not yet programmed. Due to this feature, the loads or drives connected to the individual outputs can be checked for proper functioning already during building site operation.

2.5 Operation

Manual control

The fan coil actuator has a manual control function for all valve, fan level or simple switching outputs. The button field with 4 function keys and 3 status LEDs on the front panel of the device can be used for setting and controlling the following modes of operation...

- Bus operation: operation from other bus devices (e.g. room thermostats, push-buttons, etc.),
- Temporary manual control: manual control via the button field, automatic return to bus operation,
- Permanent manual control: exclusively manual control of the device via the button field, return to bus operation only after manual control is aborted manually.

i The operating modes can be enabled or disabled by parameter settings in the ETS.

i When manual control is active, the outputs cannot be controlled via the bus.

i Manual control is possible only while the actuator is supplied with power from the mains. The bus supply voltage does not have to be connected or switched on, however (building site operation).

Manual control is terminated automatically in the event of a mains voltage failure, at the beginning of any ETS programming process, or in the event of bus voltage return. Manual control cannot be activated or continued during an ETS programming process.

i Manual control in the bus mode can be disabled by a telegram. Manual control is terminated on activation of the disabling function.

i No manual control of the device is possible if the fan coil actuator is programmed by the ETS with an incorrect application program or if the application program was unloaded. In the state of the actuator as supplied (see chapter 4.2.4.6. State as supplied), manual control can be used even before commissioning via the ETS (building site operation).

i Further details concerning manual control, especially with respect to the possible parameter settings and the interaction with other functions of the fan coil actuator can be found in chapter 4, "Software description" of the present documentation.

Controls and indicators for manual control

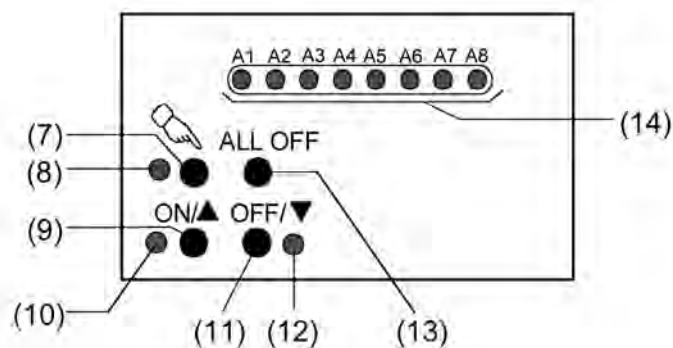

Figure 6: Controls and indicators for manual control

- (7) Button : Activation / deactivation of manual control.
- (8) LED : LED ON indicates permanent manual control.
- (9) Button ON/ ▲: Press: output ON (close relay contact)
- (10) Status LED ON/ ▲: LED ON in manual control indicates a switched-on output (relay contact closed).

- (11) Button OFF/ ▼:
Press: output OFF (close relay open)
- (12) Status LED OFF/ ▼:
LED ON in manual control indicates a switched-off output (relay contact open).
- (13) Button ALL OFF:
All outputs OFF (only in permanent manual control)
- (14) Status LEDs A1 ... A8:
LED ON indicates statically closed relay contacts or outputs in control via the bus or via manual control.
One LED flashes slowly for each output that has been selected in manual control. All LEDs of a fan coil channel flash quickly if the bus operation of this channel has been disabled via manual control.

Combination options for the outputs in manual control

The fan coil actuator can be adapted very flexibly to the specific application required by means of parameter settings in the ETS. The parameter settings selected in the ETS directly affect the activation of the outputs in manual control:

The actuator can be used to control one or two fan coil devices by configuring one-channel or alternatively two-channel operation. With only one channel the outputs A1 to max. A8 form the valve and fan level outputs. As soon as two channels are set, the outputs A1 to max. A3 form channel 1 and outputs A4 to max. A8 form channel 2.

The number of possible fan levels is thus limited by the specified number of the fan coil channels. Furthermore, the possible number of valve outputs for heating or cooling is dependent on the fan coil system selected in the ETS (2-pipe or 4-pipe).

Also, fan levels of a fan coil channel which are not used can optionally be used as switching outputs with a simple switching function.

In manual control all relay outputs of the actuator can be operated, i.e. switched on or off, directly. Depending on the parameter settings in the ETS, the switching of an output can, depending on the configuration of the fan levels or of the fan coil system (heating, cooling, or heating & cooling), result in automatic changes in further outputs of the fan coil channel concerned.

The following tables show examples of the possible combinations of valve outputs, fan levels and switching outputs, depending on the parameter settings in the ETS...

I. Combination example for one fan coil channel (6 fan levels and 2-pipe heating):

A1	A2	A3	A4	A5	A6	A7	A8
Heating	Not used	Level 1	Level 2	Level 3	Level 4	Level 5	Level 6

II. Combination example for one fan coil channel (6 fan levels and 2-pipe heating/cooling):

A1	A2	A3	A4	A5	A6	A7	A8
Heating/ Cooling	Not used	Level 1	Level 2	Level 3	Level 4	Level 5	Level 6

III. Combination example for one fan coil channel (4 fan levels and 4-pipe heating/cooling + 2 independent switching outputs):

A1	A2	A3	A4	A5	A6	A7	A8
Cooling	Heating	Level 1	Level 2	Level 3	Level 4	Switching	Switching

IV. Combination example for two fan coil channels (channel 1 : 3 fan levels and 2-pipe heating + channel 2: 3 fan levels and 2-pipe cooling):

A1	A2	A3	A4	A5	A6	A7	A8
Heating	Level 1	Level 2	Level 3	Cooling	Level 1	Level 2	Level 3

V. Combination example for two fan coil channels (channel 1 : 2 fan levels and 2-pipe heating/cooling + channel 2: 3 fan levels and 2-pipe heating/cooling):

A1	A2	A3	A4	A5	A6	A7	A8
Heating/ Cooling	Level 1	Level 2	Switching	Heating/ Cooling	Level 1	Level 2	Level 3

- i** When only one fan coil channel and the settings "2-pipe only heating", "2-pipe only cooling" and "2-pipe heating/cooling ..." are used, then output 2 is not used. Thus this output cannot be selected in manual control.
- i** The parameterised output combination is displayed in the ETS on the last parameter page as a connection help.

Consideration of the fan levels in manual control:

The control concept for manual control always takes the following ETS settings into account for control of the fan levels (the values printed in **bold** correspond to the unprogrammed state of the actuator as supplied):

- Number of fan coil channels (**1**...2)
- Fan coil system (2-pipe, **4-pipe**),
- Number of fan levels (1...3 or 1...**6**),
- Control of the fan levels (**change-over principle**, level principle),
- Dwell time for level change-over or pause "OFF" for level change-over (0...**1.0 s**...2.9 s).

In manual control of the fan levels the "Control of the fan levels" parameterised in the ETS is evaluated. Thus manual control is subject either to the change-over principle (only one level output is switched on – lower levels are switched off again), or to the level principle (the fan level outputs are switched one after another – lower levels remain switched on). As a basic principle, even in manual control, when there is a change of the fan level the pause "OFF" set in the ETS (change-over principle: pause by switching off between the change of a fan level) or the dwell time (level principle: dwell time in fan level for level change-over spanning several levels) is taken into account.

When a fan level is switched on (all fan levels previously OFF), then, if so parameterised in the ETS, first the switch-on level is switched on, and after the preset dwell time in the switch-on level the fan level selected by the manual control is switched on.

If all of the corresponding fan levels of a channel are switched off, then any valve still switched on (heating or cooling) is additionally switched off automatically to prevent the possibility of the fan coil device freezing or overheating.

Switch-on or switch-off delays parameterised in the ETS and a level limitation for the fan are not taken into account in manual control.

At the beginning of manual control the current fan level is initially always accepted without change. This is also the case if fan protection is being executed at the moment of activation of

manual control.

After that the fan levels can be changed in manual control.

- i Detailed descriptions of the individual parameter settings or fan level functions can be found in chapter "4. Software description" of the present documentation.

Consideration of the valve positions in manual control:

The control concept for manual control always takes the following ETS settings into account for control of the valve outputs (the values printed in **bold** correspond to the unprogrammed state of the actuator as supplied):

- Number of fan coil channels (**1...2**)
- Fan coil system (2-pipe, **4-pipe**).

At the beginning of manual control the current valve position is initially accepted without change. In 4-pipe fan coil systems, switching on a valve output (e.g. heating) causes the other valve output (e.g. cooling) of the same channel to switch off. Separate valve outputs for heating or cooling of a fan coil channel can also never be switched on at the same time in manual control!

If the fan is still switched off when a valve is switched on, then it is switched on at the lowest fan level or, if so parameterised in the ETS, initially at the switch-on level.

If valve protection is being executed at the moment that manual control is activated, then the valve protection is terminated by the actuator. This is necessary, for example, to prevent freezing of any cooling valve that may have been switched on by the valve protection, if the fan is switched off in manual control. In this case, without ventilation a switched-on cooling valve would result in freezing of the fan coil device.

- i In heating or cooling operation, at least the first fan level is always active.
- i A detailed description of the individual parameter settings or heating/cooling functions can be found in chapter "4. Software description" of the present documentation.
- i In manual control, valve protection must be considered separately: If a valve is to be switched on as a result of its protection function being executed, then the valve output is switched off immediately at the beginning of manual control. This is necessary to prevent overheating or freezing without ventilation of any valve that may have been switched off before by the valve protection.

Consideration of the simple switching outputs in manual control:

Fan levels of a fan coil channel which are not used can optionally be used as switching outputs with a simple switching function. There are no parameters in the ETS for such outputs. These outputs can also simply be switched on or off in manual control.

At the beginning of manual control the last switching state set via the bus is initially accepted without change. The switching state can be changed as desired in manual control.

The switching outputs have no effect on the valve or fan level outputs of a fan coil channel.

- i In the unprogrammed state of the actuator as supplied, no switching outputs are configured.
- i A detailed description of the switching output function can be found in chapter "4. Software description" of the present documentation.

Priorities for manual control

The fan coil actuator distinguishes between various functions that can have an effect on the a fan coil channel and thus on its outputs. In order to prevent conflicting states, each available function has a certain priority. The function with the higher priority overrides the one with the lower priority.

Manual control of the outputs of the actuator has the second-highest priority. Only the dwell time (pause time) for a level change-over has a higher priority, and is always retained even in case of manual control. If so programmed in the ETS, the switch-on level also initially overrides the one preselected manually when any fan level is switched on for the first time.



Taking into account all additional functions, the following priorities are defined....

- 1st priority: switch-on level and if necessary dwell time for switch-on level (highest priority)
- 2nd priority: dwell time / pause "OFF" for level change-over
- 3rd priority: manual control
- 4th priority: behaviour in case of mains or bus voltage return or bus voltage failure
- 5th priority: switch-on or switch-off delay of the fan levels
- 6th priority: disabling function
- 7th priority: fan level limitation
- 8th priority: valve or fan protection
- 9th priority: manual fan control
- 10th priority: normal operation (control via the bus using command values, etc.) / behaviour after the monitoring time for the command values has elapsed

Activating the temporary manual control

Manual control is enabled in the ETS.

Manual control is not disabled.

- Press the  key briefly (< 1 s).
Temporary manual control is active.
The status LED for A1 flashes (LED  remains off). The two status LEDs ON/▲ and OFF/▼ next to the lower buttons indicate the current switching status of A1.
- i** After temporary manual control is switched on, the switching states of the outputs last set initially remain active.
- i** After 5 s without a key-press, the actuator returns automatically to bus operation.

Deactivating temporary manual control

Temporary manual control is active.

- No key-press for 5 s
- or -
- Select all outputs one after another by a brief press of the key. Thereafter, press the key once again.
- or -
- Shut off the power supply or carry out a bus reset (bus voltage failure).
Manual control is terminated.
If the mains voltage is switched on, status LEDs A1...A8 indicate the current switching status of the individual outputs.
- i** The state of all outputs set via manual control is not changed when temporary manual control is switched off. If, however, a function with a priority higher than that of the normal operation (e.g. disabling function, fan level limitation or manual fan control) has been activated for the valve or fan level outputs via the bus before or during manual control, the actuator executes the function with the higher priority for the outputs concerned.

Activating permanent manual control

Manual control is enabled in the ETS.

Manual control is not disabled.

Bus operation or temporary manual control is active.

- Press the  key for at least 5 s.

Permanent manual control is active and the status LED  is illuminated.

The status LED for A1 also flashes. The two status LEDs ON/▲ and OFF/▼ next to the lower buttons show the current status of A1.

- i** After permanent manual control is switched on, the switching states of the outputs last set initially remain active.

Deactivating permanent manual control

Permanent manual control is active.

- Press the  key for at least 5 s.

- or -

- Select all outputs one after another by a brief press of the key. Thereafter, press the key once again.

- or -

- Shut off the power supply or carry out a bus reset (bus voltage failure).

Manual control is terminated.

The status LED  goes out. If the mains voltage is switched on, status LEDs A1...A8 indicate the current switching status of the individual outputs.

- i** Depending on the parameterisation of the actuator in the ETS, when permanent manual control is shut off the outputs will be set to the state last set in manual control or to the state internally tracked (e.g. disabling function, fan level limitation or manual fan control).

Controlling an output manually

In manual control the relay outputs can be controlled directly. The parameter settings selected in the ETS directly affect the activation of the outputs in manual control. This means that the switching of an output can also affect other outputs (see page 13).

Manual control (permanent or temporary) is active.

- Select the desired output: Press the  key briefly (if necessary, repeatedly).

The status LED of the selected output A1...A8 flashes. Additionally the switching state of the selected output is indicated by the status LED ON/▲ or OFF/▼ next to the lower buttons in the button field.

- Controlling an output by pressing the operating buttons in the button field.

For valve outputs:

Press button ON/▲: switch on valve output (valve opens),

Press button OFF/▼: switch off valve output (valve closes).

For fan outputs:

Press button ON/▲: switch on fan level output (fan level active),

Press button OFF/▼: switch off fan level output (fan level inactive).

For simple switching outputs (valve outputs):

Press button ON/▲: switch on switching output,

Press button OFF/▼: switch off switching output.

The selected output executes the corresponding commands immediately. The two status LEDs ON/▲ and OFF/▼ next to the lower buttons indicate the switching status of the selected output.

- i** When an output is switched on, the relay contact closes. Valve drives that close in the de-energised state must be connected to the valve outputs.

- i** When only one fan coil channel and the settings "2-pipe only heating", "2-pipe only cooling" and "2-pipe heating/cooling ..." are used, then output 2 is not used. Thus this output cannot be selected in manual control.
- i** In temporary manual control: After running through all of the the outputs, the device leaves manual control when the button  is pressed again.
- i** Depending on the parameter configuration in the ETS, if necessary feedback telegrams are transmitted to the bus via the feedback objects of a channel ("Feedback for active fan level" and "Feedback for fan coil active") during control.

Switching off all outputs

It is possible to switch off all outputs of the actuator (valve, fan level and also simple switching outputs) at the same time.

Permanent manual control is active.

- Press the ALL OFF key.
All outputs of the actuator are switched off immediately. The outputs are not locked. Individual activation is again possible after shutoff.
- i** The "ALL OFF" function is not available in temporary manual control. In this case pressing this button produces no reaction.

Disabling bus control of individual outputs manually

It is possible to use manual control to disable an entire fan coil channel (all associated valve and fan level outputs) or a simple switching output in such a way that the associated outputs can no longer be activated via the bus.

Permanent manual control is active.

Disabling of the bus control mode must have been enabled in the ETS.

- Select any desired output of the fan coil channel or of the switching output that is to be disabled: press  button briefly (several times if necessary).
The status LED of the selected output A1...A8 flashes. Additionally the switching state of the selected output is indicated by the status LED ON/ ▲ or OFF/ ▼ next to the lower buttons in the button field.
- Press the ON/ ▲ and OFF/ ▼ buttons simultaneously for at least 5 s.
The selected fan coil channel or switching output is disabled (control via the bus is no longer possible).
All status LEDs of the disabled fan coil channel or switching output flash quickly permanently (even with manual control deactivated).
- i** An output that has been disabled in manual control can thereafter only be operated in permanent manual control.
- i** If a disabled output is selected in manual control, the LEDs flash twice briefly with a time interval.

Cancelling the disabling of bus control of individual outputs via manual control.

Permanent manual control is active.

Bus control of a fan coil channel or a simple switching output has been disabled previously in permanent manual control.

- Select any desired output of the fan coil channel or of the switching output that is to be re-enabled: press  button briefly (several times if necessary).
The status LED of the selected output A1...A8 flashes twice briefly with a time interval. Additionally the switching state of the selected output is indicated by the status LED ON/▲ or OFF/ ▼ next to the lower buttons in the button field.
- Press the ON/ ▲ and OFF/ ▼ buttons simultaneously for at least 5 s.

The selected fan coil channel or switching output is re-enabled (control via the bus is possible again after manual control is deactivated).

The status LED of the selected output A1...A8 flashes.

3 Technical data

Technical data

General

Protection rating	IP 20
Safety class	II
Mark of approval	KNX / EIB / VDE
Ambient temperature	-5 ... +45 °C
Storage/transport temperature	-25 ... +70 °C (Storage above +45 °C reduces the lifetime.)
Installation position	as desired (preferably top output terminals)
Minimum distances	none
Fixing type	Snapping onto top hat rails in closed housing (e.g. small distribution board, etc.)

Terminals for mains supply and outputs

Connection mode	Screw terminal
Single stranded	0.5 ... 4 mm ²
Finely stranded without conductor sleeve	0.35 ... 4 mm ²
Finely stranded with conductor sleeve	0.14 ... 2.5 mm ²
Connection torque	max. 0.8 Nm

KNX / EIB supply

KNX medium	TP 1
Commissioning mode	S-mode
Rated voltage KNX	DC 21 ... 32 V SELV
Power consumption KNX	typical 150 mW
Connection mode KNX	Standard KNX/EIB connection terminals

External supply

Rated voltage	AC 230 / 240 V ~
Mains frequency	50 / 60 Hz
Power loss	max. 3 W

Outputs

Contact type	μ contact, potential-free NO contact
Mains frequency	50 / 60 Hz
Contact rating AC1	10 A
Contact rating AC3 (cosφ=0.65)	10 A
Switch-on current 200 μs	max. 800 A
Switch-on current 20 ms	max. 165 A
Minimum switching current AC	100 mA

Breaking capacity per output

Ohmic load	2300 W
Capacitive load 10A	max. 140 μF
Motors	1380 VA
Lamp loads:	
Incandescent lamps	2300 W
HV halogen lamps	2300 W
Inductive transformers	1200 VA
Tronic transformers	1500 W
Fluorescent lamps, uncompensated	1000 VA
Fluorescent lamps, parallel compensated	1160 VA (140 μF)
Fluorescent lamps, duo circuit	2300 VA (140 μF)
Mercury vapour lamps, uncompensated	1000 W
Mercury vapour lamps, parallel compensated	1160 W (140 μF)
Electronic ballast	Type-dependent

The number of electrical ballasts that can be connected depends on the type and manufacturer, and is also dependent on the characteristics of the low-voltage installation network. For this reason, various electrical ballast types are listed below as examples (manufacturer: Osram / as at 01.2007). Max. number per output (for 25,000 switching cycles).

T8 lamps:	
QTP 2 x 58 W	11
T5 lamps:	
QT-FH 4 x 14 W	10
QT-FQ 2 x 54 W	11

4 Software description

4.1 Software specification

ETS search paths:	Heating, air condition, ventilation / Fan coil / Fan coil actuator 2-gang 10A SE
Build used:	TPUART + μ C
KNX/EIB type class:	3b device with cert. PhL + stack
Configuration:	S mode standard
PEI type:	"00" _{Hex} / "0" _{Dec}
PEI connection:	No connector

Applications:

No.	Short description	Name	Version	from mask version
1	Multifunction fan coil application: 1-channel or 2-channel operation / up to 5 different fan coil systems (heating & cooling / 2-pipe & 4-pipe). With manual control.	Switching, fan coil 20B001	0.1 for ETS 2 and ETS 3.0a...c	705
2	Multifunction fan coil application: 1-channel or 2-channel operation / up to 5 different fan coil systems (heating & cooling / 2-pipe & 4-pipe). With manual control.	Switching, fan coil 20B011	1.1 for ETS3.0 version d onwards	705

4.2 Software "Switching fan coil 20B0x1"

4.2.1 Scope of functions

General scope of functions

- 1-channel operation or alternatively 2-channel operation configurable.
 - Up to 5 different fan coil systems can be set:
 - 2-pipe system only heating (in 1-channel and 2-channel operation),
 - 2-pipe system only cooling (in 1-channel and 2-channel operation),
 - 2-pipe system heating/cooling via change-over object (in 1-channel and 2-channel operation),
 - 4-pipe system heating/cooling via change-over object (only in 1-channel operation),
 - 4-pipe system heating/cooling via command value specification (only in 1-channel operation),
- "2-pipe system": a common valve for heating and cooling,
"4-pipe system": Two separate valves for heating and cooling,
"via change-over object": Change-over of the mode of operation (heating / cooling) via a separate 1-bit communication object,
"via command value specification": Change-over of the mode of operation (heating / cooling) directly via the command values.
- Actively transmitting feedback or status messages can be delayed globally after bus voltage return or after ETS programming.
 - Manual control of outputs independent of the bus (for instance, building site operation) with LED state indicators. Separate status feedback to the bus for manual control. Manual control can also be disabled via the bus.
 - Connection help in the ETS parameter view makes it easier to connect the individual outputs to the intended loads.

Channel-oriented scope of functions (separate for each fan coil channel)

- Reactions to bus voltage failure and bus and mains voltage return can be set. The output states at the time of bus or mains voltage failure can be saved and subsequently tracked. The behaviour after ETS programming is set to "switch off", and cannot be changed.
- Read request possible for mode of operation change-over in case of change-over via object.
- Valve and fan protection configurable. The fan protection can be suppressed via a separate bus communication object.
- Number of fan levels can be adjusted in the ETS. In 1-channel operation up to 6 fan levels can be configured, in 2-channel operation up to 3 fan levels each.
- Fan levels can be controlled using the change-over principle (only one fan level output is switched on) or level principle (fan level outputs switch hierarchically).
- Pause "OFF" for level change-over (in change-over principle) or dwell time (in level change-over) can be set. This allows adaptation to time specifications of fan coil unit manufacturers.
- Command value ranges for the fan levels can be adjusted flexibly. Assignment is carried out in the ETS by parameterising a command value (1...100 %) for each fan level. Incl. hysteresis in the event of switching-back of the level to avoid continual change-over of the fan levels when the command value is located at the border between two fan levels.
- Switch-on behaviour of the fan parameterisable. Optional switching-on via independent switch-on level with dwell time.
- Switch-on delay of the fan for heating or switch-off delay of the fan for cooling configurable in the ETS.
- A level limitation of the fan can be activated via a separate 1-bit object. This allows limitation of the maximum fan level to a fan level value specified in the ETS.

- Feedback for the active fan level either as an active signalling object (transmitting in the event of an update) or as a passive status object (readable). The data format of the feedback can be configured either as a 1-byte value (feedback for the active fan level via a value-coded telegram) or alternatively as a 1-bit switching state (feedback for the active fan level via several status objects available for each fan level).
It is also possible to parameterise a channel feedback "Fan coil active". As soon as any output of a fan coil channel is switched on, the actuator signals an activity via this feedback.
All feedback telegrams can be transmitted to the bus with a delay after bus voltage return or after programming with the ETS (as long as actively transmitting).
Cyclical transmitting of the feedback telegrams is also possible. The cycle time is configured in the actuator independent of the channel (cycle time identical for all channels).
In addition, the current status of the feedback telegrams can be requested via a 1-bit request object.
- Manual fan control possible:
The fan of the connected fan coil unit can be activated in accordance with requirements "by hand" - for example using a push-button on the wall or an operating panel installed in a central location. This enables a purely ventilation function.
Data format of the manual control can be set to either 1 bit or 1 byte.
The manual fan control can be activated/deactivated in accordance with requirements. Separate communication objects are available for this, depending on the application.
In addition, it is possible to force activation of manual fan control after return of bus or mains voltage or after ETS programming.
- The command value telegrams can be monitored cyclically. Monitoring time interval configurable from 1 minute to 23 hours 59 minutes.
Reaction after the monitoring time has elapsed without receipt of a command value parameterisable. In addition, a 1-bit fault message can be sent to the bus in the event of a fault.
- Disabling function possible. Each fan coil channel can be locked via a 1-bit communication object, so that command value control of the channel outputs via the bus is no longer possible. Behaviour at the beginning and end of the disabling configurable.

4.2.2 Notes on the software

ETS configuration and commissioning

For configuration and commissioning of this device it is recommended to use ETS3.0d. Advantages with regard to downloading (significantly shorter loading times) and parameter configuration can be expected only if this ETS patch version or later versions are used. The advantages are gained through the use of the new mask version 7.5 and the parameter presentation of ETS3.

The product database necessary for ETS3.0d is provided in *.VD4 format. The corresponding application program has the version number "1.1".

For ETS2 and older versions of ETS3, a separate product database is available in *.VD2 format. The application program for these ETS versions has the version number "0.1".

As far as the scope of functions of the parameters described in this documentation is concerned, there is no difference between the two application programs.

In the case of an update from older ETS versions to ETS3.0d or to newer version, an additional tool is available as an ETS3 add-in. This tool is able to convert older product databases with application version "0.1" – for example from existing ETS2 projects – into the new application format (version "1.1"). This way you can make use of the advantages of the ETS3.0d application easily and without changing the configuration. The ETS3 add-in can be obtained separately and free of charge from the manufacturer.

Safe-state mode

If the device does not work properly - for instance as a result of errors in the project design or during commissioning - the execution of the loaded application program can be halted by activating the safe-state mode. The safe-state mode does not permit controlling the outputs via the bus and by hand. The actuator remains passive since the application program is not being executed (state-of-execution: terminated). Only the system software is still functional so that the ETS diagnosis functions and also programming of the device continue to be possible.

Activating the safe-state mode

- Shut off the bus and the mains voltage supply.
- Press the programming button and keep it pressed.
- Switch on the bus or mains voltage. Release the programming button only after the programming LED starts flashing slowly.

The safe-state mode is activated. With a new brief press on the programming button, the programming mode can be switched on and off as usual also in the safe-state mode. The programming LED will nevertheless continue to flash independently of the programming mode as long as the safe-state mode is active.

- i** The safe-state mode can be terminated by switching off the supply voltage (bus and mains) or by programming with the ETS.

Unloading the application program

The application program can be unloaded with the ETS. In this case, manual control as part of the application program is not available either.

4.2.3 Object table

Number of communication objects:	45 (max. object number 47 - gaps in between)
Number of addresses (max):	254
Number of assignments (max):	255
Dynamic table management	No
Maximum table length	255

Channel-independent objects

Function: Manual operation

Object	Function	Name	Type	DPT	Flag
 ⁰	Disabling	Manual operation	1-bit	1.003	C, W, -, (R) ₁

Description 1-bit object for disabling the buttons for manual control on the device. The polarity can be configured.

Function: Manual operation

Object	Function	Name	Type	DPT	Flag
 ¹	Status	Manual operation	1-bit	1.002	C, -, T, (R) ₁

Description 1-bit object for manual control status transmission. The object is "0", when manual control is deactivated (bus control). The object is "1" when manual control is being activated. You can configure whether the temporary or the permanent manual control will be indicated as status information or not.

Channel-oriented objects

Function: Command value

Object	Function	Name	Type	DPT	Flag
 ^{2, 22}	Command value for heating	Channel 1, channel 2	1 byte	5.001	C, W, -, (R) ₁

Description 1-byte object for specifying the command value for heating for the fan coil actuator. Value range: 0...255 (0...100 %).

Function: Command value

Object	Function	Name	Type	DPT	Flag
 ^{3, 23}	Command value for cooling	Channel 1, channel 2	1 byte	5.001	C, W, -, (R) ₁

Description 1-byte object for specifying the command value for cooling for the fan coil actuator. Value range: 0...255 (0...100 %).

1: For reading, the R-flag must be set. The last value written to the object via the bus will be read.

Function: Mode of operation change-over

Object	Function	Name	Type	DPT	Flag
 4, 24	Heating/cooling change-over	Channel 1, channel 2	1 bit	1.001	C, W, (T), (R) ^{1,2}

Description 1-bit object for mode of operation change-over. Only visible in the fan coil systems "2-pipe heating / cooling via change-over object" and "4-pipe heating / cooling via change-over object". Polarity: "0" = cooling / "1" = heating.

Function: Feedback

Object	Function	Name	Type	DPT	Flag
 5, 25	Feedback for fan coil active	Channel 1, channel 2	1 bit	1.002	C, W, (T), (R) ³

Description 1-bit object for feedback of an active fan coil channel. Polarity: "0" = complete fan coil channel inactive (All outputs OFF); "1" = any output of the fan coil channel is switched on.

Function: Feedback

Object	Function	Name	Type	DPT	Flag
 6, 26	Feedback for fan level 1	Channel 1, channel 2	1 bit	1.001	C, W, (T), (R) ³

Description 1-bit object for feedback of an active fan level 1. Only visible if the type of fan level feedback is configured to "Fan levels individually" in the ETS. Polarity: "0" = Fan level 1 deactivated; "1" = Fan level 1 activated.

Function: Feedback

Object	Function	Name	Type	DPT	Flag
 7, 27	Feedback for fan level 2	Channel 1, channel 2	1 bit	1.001	C, W, (T), (R) ³

Description 1-bit object for feedback of an active fan level 2. Only visible if the type of fan level feedback is configured to "Fan levels individually" in the ETS and at least 2 levels are enabled. Polarity: "0" = Fan level 2 deactivated; "1" = Fan level 2 activated.

1: After device initialisation, the object can request the current object value from the bus via a read request. This behaviour can be parameterised in the ETS. The ETS sets the T-flag automatically if a read request is configured.

2: For reading, the R-flag must be set. The last value written to the object via the bus will be read.

3: The communication flags are set automatically depending on the configuration. "T" flag for active signalling object; "R" flag for passive status object.

Function: Feedback

Object	Function	Name	Type	DPT	Flag
 ^{8, 28}	Feedback for fan level 3	Channel 1, channel 2	1 bit	1.001	C, W, (T), (R) ¹

Description 1-bit object for feedback of an active fan level 3. Only visible if the type of fan level feedback is configured to "Fan levels individually" in the ETS and at least 3 levels are enabled.
Polarity: "0" = Fan level 3 deactivated; "1" = Fan level 3 activated.

Function: Feedback

Object	Function	Name	Type	DPT	Flag
 ⁹	Feedback for fan level 4	Channel 1	1 bit	1.001	C, W, (T), (R) ¹

Description 1-bit object for feedback of an active fan level 4. Only visible if the type of fan level feedback is configured to "Fan levels individually" in the ETS and at least 4 levels are enabled.
Polarity: "0" = Fan level 4 deactivated; "1" = Fan level 4 activated.

Function: Feedback

Object	Function	Name	Type	DPT	Flag
 ¹⁰	Feedback for fan level 5	Channel 1	1 bit	1.001	C, W, (T), (R) ¹

Description 1-bit object for feedback of an active fan level 5. Only visible if the type of fan level feedback is configured to "Fan levels individually" in the ETS and at least 5 levels are enabled.
Polarity: "0" = Fan level 5 deactivated; "1" = Fan level 5 activated.

Function: Feedback

Object	Function	Name	Type	DPT	Flag
 ¹¹	Feedback for fan level 6	Channel 1	1 bit	1.001	C, W, (T), (R) ¹

Description 1-bit object for feedback of an active fan level 6. Only visible if the type of fan level feedback is configured to "Fan levels individually" in the ETS and at least 6 levels are enabled.
Polarity: "0" = Fan level 6 deactivated; "1" = Fan level 6 activated.

Function: Feedback

Object	Function	Name	Type	DPT	Flag
 ^{12, 32}	Feedback for active fan level	Channel 1, channel 2	1 byte	5.010	C, W, (T), (R) ¹

Description 1-byte object for feedback of the active fan level. Only visible if the type of fan level feedback is configured to "Fan levels via value" in the ETS.
Value range: 0...max. 6. The maximum value is limited by the number of configured fan levels.

1: The communication flags are set automatically depending on the configuration. "T" flag for active signalling object; "R" flag for passive status object.

Function: Request feedback

Object	Function	Name	Type	DPT	Flag
 13, 33	Feedback for active fan level	Channel 1, channel 2	1 bit	1.017	C, W, -, (R) 1

Description 1-bit object for requesting feedback telegrams. As soon as any switching telegram ("0" or "1") is received via this object, the actuator immediately initiates transmission of the feedback telegrams "Active fan level" and "Fan coil active".

Function: Disabling function

Object	Function	Name	Type	DPT	Flag
 14, 34	Disabling function	Channel 1, channel 2	1 bit	1.003	C, W, -, (R) 1

Description 1-bit object for activating and deactivating the disabling of a fan coil channel. Polarity parameterisable.

Function: Cyclical monitoring

Object	Function	Name	Type	DPT	Flag
 15, 35	Fault message for cyclical monitoring	Channel 1, channel 2	1 bit	1.002	C, -, T, (R) 1

Description 1-bit object for indicating a fault (missing command value telegram) in the cyclical monitoring of the command values. Polarity: "0" = no fault / "1" = fault.

Function: Fan protection

Object	Function	Name	Type	DPT	Flag
 16, 36	Enable fan protection	Channel 1, channel 2	1 bit	1.003	C, W, -, (R) 1

Description 1-bit object for enabling the fan protection. Polarity: "0" = fan protection disabled / "1" = fan protection enabled.

Function: Level limitation

Object	Function	Name	Type	DPT	Flag
 17, 37	Level limitation	Channel 1, channel 2	1 bit	1.003	C, W, -, (R) 1

Description 1-bit object for activating and deactivating the level limitation. Polarity: "0" = level limitation deactivated / "1" = level limitation activated.

1: For reading, the R-flag must be set. The last value written to the object via the bus will be read.

Function: Manual fan control

Object	Function	Name	Type	DPT	Flag
 18, 38	Manual fan control active/inactive (deactivate)	Channel 1, channel 2	1 bit	1.003	C, W, -, (R) ₁

Description

1-bit object for activating and deactivating manual fan control. Depending on the parameter settings, the fan control can either be activated and deactivated via this object (object function "Manual fan control active/inactive"), or alternatively only deactivated (object function "Deactivate manual fan control"). The polarity is also dependant on this parameter configuration:
 Object function "Manual fan control active/inactive":
 "0" = deactivate control / "1" = Activate control
 Object function "Deactivate manual fan control":
 "0" = deactivate control / "1" = no reaction.

Function: Manual fan control

Object	Function	Name	Type	DPT	Flag
 19, 39	Manual fan control specification	Channel 1, channel 2	1 byte	5.010	C, W, -, (R) ₁

Description

1-byte object for direct specification of the fan level in manual fan control. This object is only visible if the data format of the specification object is configured to "Value object (1 byte)".
 Value range: 0 ... max. 6. The maximum value is limited by the number of configured fan levels. Values greater than the maximum fan level are interpreted by the actuator like the maximum value.

Function: Manual fan control

Object	Function	Name	Type	DPT	Flag
 20, 40	Manual fan control specification	Channel 1, channel 2	1 bit	1.007	C, W, -, (R) ₁

Description

1-bit object for specification the fan level via the switching direction in manual fan control. This object is only visible if the data format of the specification object is configured to "Switching direction object (1 bit)".
 Polarity: "0" switch level down / "1" = switch level up.
 Switching up is possible as far as the maximum fan level.

Function: Manual fan control

Object	Function	Name	Type	DPT	Flag
 21, 41	Manual fan control feedback	Channel 1, channel 2	1 bit	1.002	C, -, T, (R) ¹

Description

1-bit object for feedback of active manual fan control.
 Polarity: "0" = manual fan control inactive / "1" = manual fan control active.

1: For reading, the R-flag must be set. The last value written to the object via the bus will be read.

Function: Simple switching function

Object	Function	Name	Type	DPT	Flag
 ⁴²	Switching	Output 8	1 bit	1.001	C, W, -, (R) 1

Description Unused fan level outputs can be used as simple switching outputs. 1-bit object for control of the simple switching output 8.

Function: Simple switching function

Object	Function	Name	Type	DPT	Flag
 ⁴³	Switching	Output 7	1 bit	1.001	C, W, -, (R) 1

Description Unused fan level outputs can be used as simple switching outputs. 1-bit object for control of the simple switching output 7.

Function: Simple switching function

Object	Function	Name	Type	DPT	Flag
 ⁴⁴	Switching	Output 6	1 bit	1.001	C, W, -, (R) 1

Description Unused fan level outputs can be used as simple switching outputs. 1-bit object for control of the simple switching output 6.

Function: Simple switching function

Object	Function	Name	Type	DPT	Flag
 ⁴⁵	Switching	Output 5	1 bit	1.001	C, W, -, (R) 1

Description Unused fan level outputs can be used as simple switching outputs. 1-bit object for control of the simple switching output 5.

Function: Simple switching function

Object	Function	Name	Type	DPT	Flag
 ⁴⁶	Switching	Output 4	1 bit	1.001	C, W, -, (R) 1

Description Unused fan level outputs can be used as simple switching outputs. 1-bit object for control of the simple switching output 4.

Function: Simple switching function

Object	Function	Name	Type	DPT	Flag
 ⁴⁷	Switching	Output 3	1 bit	1.001	C, W, -, (R) 1

Description Unused fan level outputs can be used as simple switching outputs. 1-bit object for control of the simple switching output 3.

1: For reading, the R-flag must be set. The last value written to the object via the bus will be read.

4.2.4 Functional description

4.2.4.1 Application basics

Definition of terms and functional principle

The term "fan coil" means that a fan sucks in air and blows it through a heat exchanger, which generally consists of a coil-shaped or ribbed heating or cooling register. The temperature of the sucked-in air is thus climate-controlled, i.e. heated or cooled.

Another term for fan coil is "blower convector".

Fan coil units are used to control the temperature of rooms, and are a kind of air/water climate control system. Such devices are operated either using the recirculating air principle, or primarily in larger climate control systems in fresh air or mixed air operation.

Fan coil units exist in a wide variety of designs, all of them quite common: devices for wall, ceiling or duct installation, free-standing or integrated horizontally or vertically into enclosures or intermediate ceilings.

In principle fan coil units function like conventional radiators. However, the air circulation is supported by a blower. In this manner the heat or cold output can be increased significantly, meaning that such devices can also be employed to heat large rooms. It is possible to bring rooms to a comfortable air temperature in a very short time.

The devices are as a rule equipped with filters, and have multi-level blowers whose speed and thus ventilation output can be varied by means of fan level inputs. Fans with up to 6 fan levels are encountered in practise. To reduce noise emissions, the fans are often designed as tangential fans (cross flow fans) (figure 7).

The heating or cooling energy is supplied to the heat exchanger primarily via pipes that are designed as forward flow and return flow lines. The forward flow lines contain electrically controllable valves, for example equipped with 230 V ~ electrothermal drives or electric motor-driven valve drives, which activate either heating operation or cooling operation.

In many cases the valve drives are a direct component of the fan coil, or have to be mounted on the valves in the fan coil unit as suitable accessories by the electrical or HVAC installation technician during installation. If the drives are a component of the fan coil unit, the electrical connection of the valve drives is often performed in a prepared junction box together with the connections for the fan motor.

The KNX/EIB fan coil actuator uses its relay outputs to control the electrical fan level inputs and valve inputs of a fan coil unit. This assumes that the fan coil units are selected that provide the individual connections discretely in the manner described above. As a rule, such fan coils do not have their own control electronics.

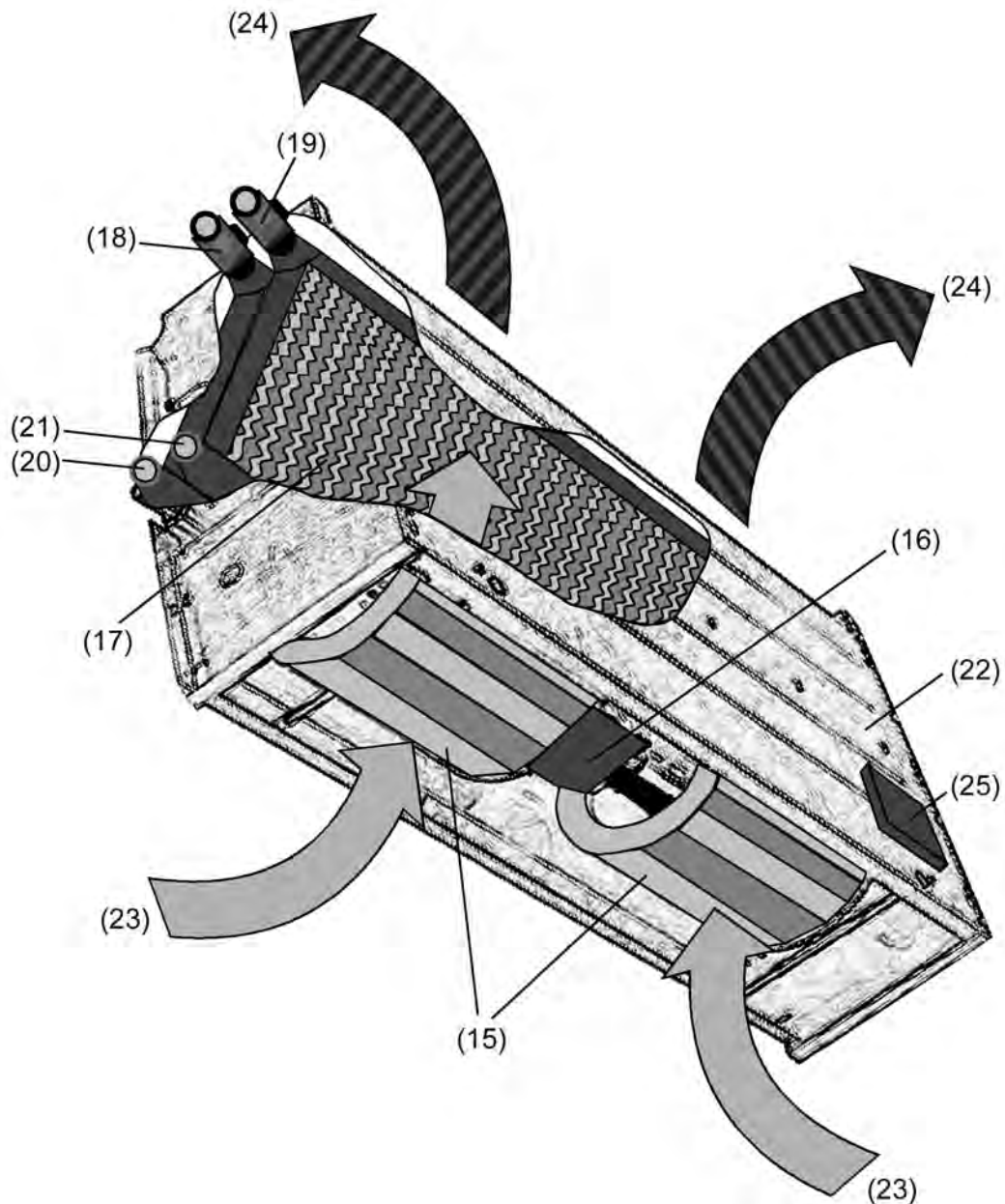

Figure 7: The fan coil principle (example based on a 4-pipe fan coil unit with upright design)

- (15) Tangential fan (cross flow fan)
- (16) Fan motor (multi-level)
- (17) Heat exchanger (incl. heating and/or cooling register)
- (18) Forward flow valve for heating
- (19) Forward flow valve for cooling
- (20) Return flow for heating
- (21) Return flow for cooling
- (22) Housing
- (23) Air sucked in (fresh air / room air)
- (24) Air blown out (cooled or heated)
- (25) Junction box for electrical valve inputs and fan level inputs

Functional differences

A fan coil unit is as a rule equipped with at least one built-in heat exchanger. Fan coil units that have only one heat exchanger are either suitable exclusively for heating or cooling, or, in special designs, also allow combined heating/cooling operation.

In such devices, the heating or cooling energy is supplied via a 2-pipe system (figure 8). One pipe is required for the forward flow, and one pipe for the return flow of the heating or cooling medium. In the case of devices that can function in a combined heating/cooling mode of operation, the exchange of the medium in the pipe (hot water or cold water) is generally performed by a higher-level building climate control system. In 2-pipe systems there is only one valve that opens or closes the water forward flow, thus enabling the heating or cooling energy.

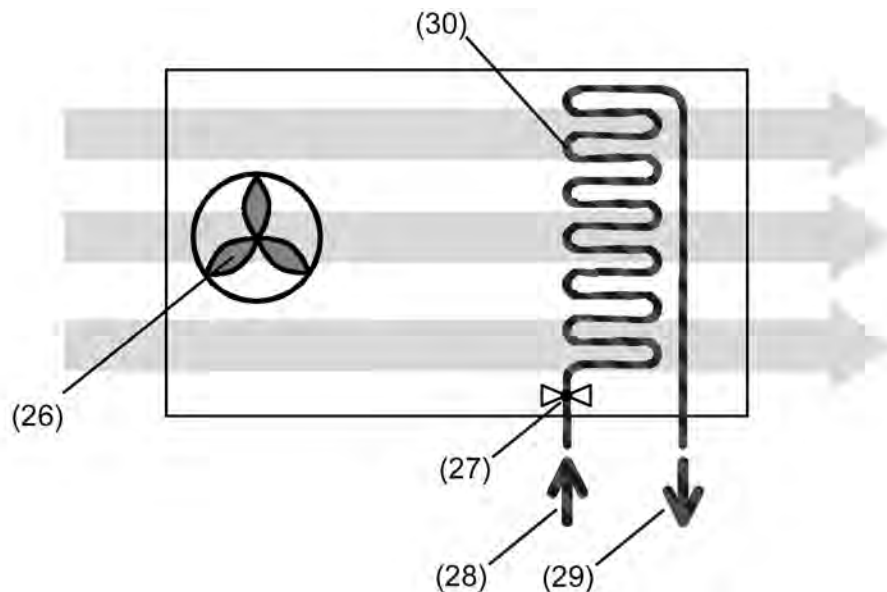

Figure 8: The 2-pipe system

- (26) Fan
- (27) Valve
- (28) Forward flow line
- (29) Return flow line
- (30) Heat exchanger (heating/cooling register)

There are also fan coil units that have either two separate heat exchangers or one heat exchanger with separate heating and cooling registers. Such devices allow independent heating or cooling operation, for which the heating or cooling energy is supplied via a 4-pipe system (figure 9). For each heat exchanger, one pipe is required for the forward flow, and one pipe for the return flow of the heating or cooling medium.

In 4-pipe systems there are two valves which open and close the separate water forward flows, thus enabling the heating or cooling energy. As a rule, simultaneous heating and cooling is not possible, nor is it advisable. As the controlling element, the KNX/EIB fan coil actuator prevents such activation of both modes of operation.

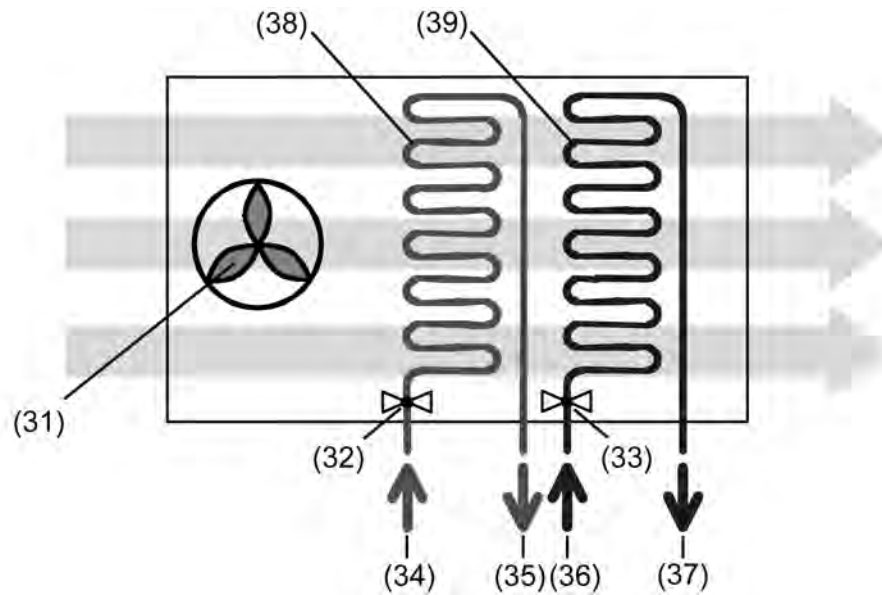

Figure 9: The 4-pipe system

- (31) Fan
- (32) Valve for heating
- (33) Valve for cooling
- (34) Forward flow line for heating
- (35) Return flow line for heating
- (36) Forward flow line for cooling
- (37) Return flow line for cooling
- (38) Heat exchanger 1 (heating register)
- (39) Heat exchanger 2 (cooling register)

- i** 3-pipe systems also exist, but these are encountered much less often. Such systems are very similar to a 4-pipe system. Here, too there are separate forward flow lines for hot and cold water, but these media share a common return flow line. Therefore two valves are also required.
The return flow is brought together either already in the fan coil unit or outside of the device in the piping system.

4.2.4.2 Description of channel-independent functions

4.2.4.2.1 Fan coil channels, the term "fan coil system" and valve functions

The fan coil actuator can be adapted very flexibly to the specific fan coil application required by means of parameter configurations. Thus one or two fan coil devices can be connected to the actuator independently of each other by configuring one-channel or alternatively two-channel operation.

Furthermore, the fan coil actuator allows control of various fan coil systems which are used in practise as 2-pipe or 4-pipe systems for heating or for cooling.

Fan coil channels

Depending on the number of fan coil channels set in the ETS, the relay outputs of the actuator are either in only one channel, or divided into two channels. With only one fan coil channel the outputs A1 to max. A8 together form the valve and fan level outputs (figure 10). When two channels are set, the outputs A1 to max. A3 form channel 1 and the outputs A4 to max. A8 form channel 2 (figure 11).

Thus the outputs have different functions depending on the number of fan coil channels and depending on the fan coil system (2-pipe or 4-pipe). The parameterised number of fan levels of a fan coil channel also directly determines the output functions (see "Configuration of the fan levels").

Number of fan coil channels	Number of valve outputs	Number of fan levels
1 channel (1 fan coil device)	1 ... 2 valve outputs	1 ... max. 6 fan levels
2 channels (2 fan coil devices)	one valve output each	1 to max. 3 fan levels each

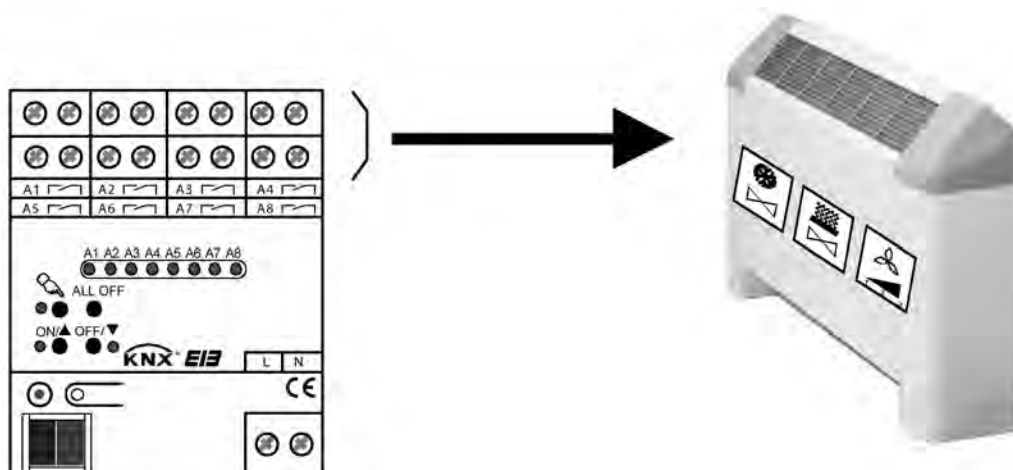

Figure 10: 1-channel operation

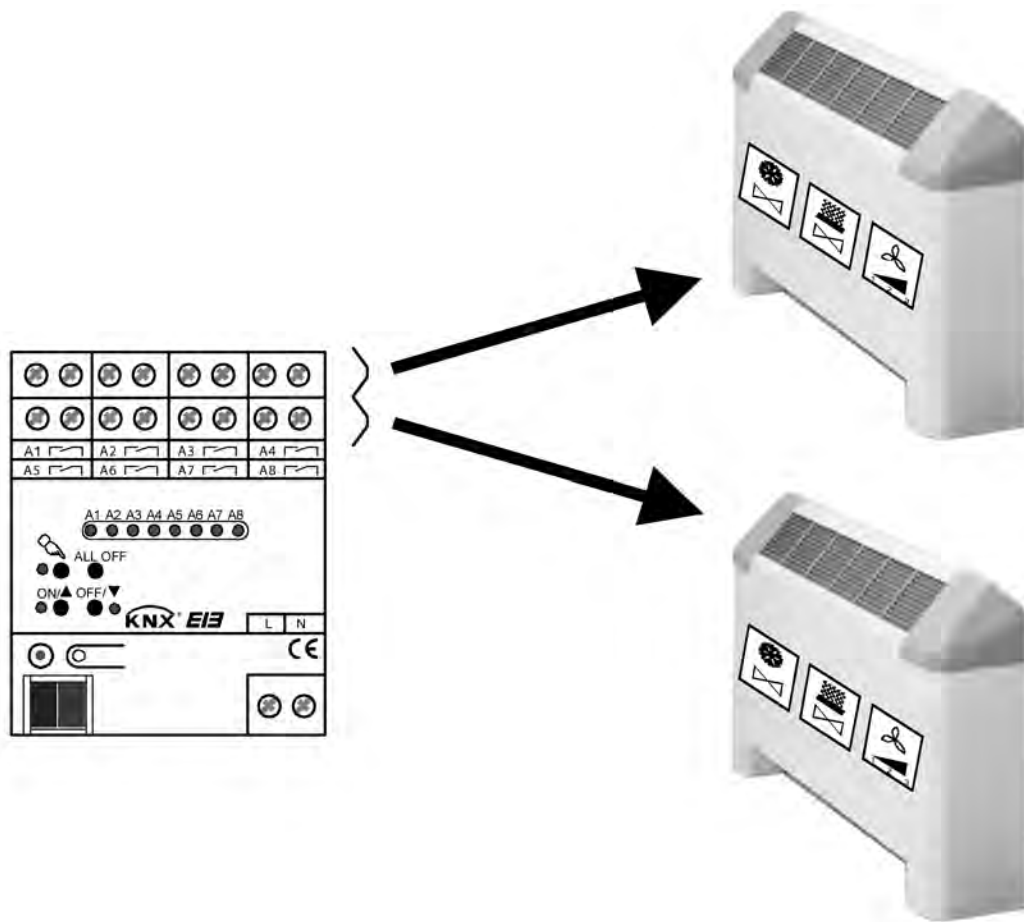

Figure 11: 2-channel operation

- i** Depending on the parameter settings in the ETS, the switching of an output can, depending on the configuration of the fan levels or of the fan coil system, result in automatic changes in further outputs of the fan coil channel concerned.
- i** The number of fan levels is limited by the specified number of fan coil channels, and can moreover be parameterised in the ETS separately for each fan coil channel (see chapter 4.2.4.3.3. Basic configuration of the fan levels).
- i** Fan level outputs of a fan coil channel which are not used can optionally be used as switching outputs with a simple switching function.

Setting the number of fan coil channels

The number of required fan coil channels is set in the ETS. Depending on the number set, the relay outputs of the actuator are either in only one channel, or divided into two channels.

- Set the parameter "Number of fan coil channels" on the parameter page "General" to "1 fan coil channel (maximum of 6 fan levels)".

All valve and fan level outputs of the actuator are assigned to just one fan coil channel. A fan coil unit can be connected to the device. In this configuration a maximum of 6 fan levels can be set.

- Set the parameter "Number of fan coil channels" on the parameter page "General" to "2 fan coil channels (maximum of 3 fan levels)".

The valve and fan level outputs of the actuator are combined into two pairs, each of which is assigned to one fan coil channel. It is thus possible to connect two fan coil units to the fan coil actuator. In this configuration a maximum of 3 fan levels can be set per channel.

- i** This parameter should be set at the beginning of the device parameterisation, because all further channel-oriented parameters are dependent on this setting. If the parameter is only changed during the course of a device configuration, the assignments of group addresses to objects could be lost or parameter settings could be reset!
- i** In the ETS parameterisation, the parameter page "Connection help for output assignment" shows the functions of the up to 8 outputs in accordance with the parameter settings.

Fan coil system

The fan coil actuator generally converts 1-byte command value telegrams, which it receives, for example, from KNX/EIB room thermostats, into the equivalent fan levels. To do this, the actuator controls its relay outputs for the fan levels based on a command value weight parameterised in the ETS.

The fan coil actuator can be used either in the individual modes of operation "Heating" or "Cooling" or alternatively in the combination mode of operation "Heating / cooling". This means that based on the command values received the actuator not only ventilates, but also controls heating or cooling valves of a fan coil unit.

In the combination mode of operation "Heating / cooling", in normal operation the fan coil actuator is given information whether to heat or cool "from outside" via the bus. The actuator then decides either based on the command value specification or based on a separate switching object which mode of operation has to be performed. This information is communicated to the fan coil actuator either via a higher-level HVAC controller or via the mode of operation specification of a room thermostat.

In application practise with fan coil units, a distinction is also made between systems which supply the heating or cooling energy to the device either via a 2-pipe system or via a 4-pipe system.

In a 2-pipe system as a rule only a single common heating and/or cooling register is used in the fan coil unit. For this reason only one valve is required for the combined heating and cooling forward flow line. The change of the heating or cooling medium in the pipe is often performed here by a higher-level building HVAC controller. 2-pipe systems are used as standard in a simple application when only heating or cooling is required.

In a 4-pipe system there are usually two different heating and cooling registers in the fan coil unit. The heating and cooling forward flow lines are separate, meaning that two valves are required for flow control. In this application the valves must be mutually interlocked in order to prevent simultaneous heating and cooling. This task is performed fully automatically by the fan coil actuator.

Because in a 4-pipe system the fan coil actuator has to provide two separate valve outputs, and the fan level outputs also have to be taken into account, due to the maximum number of 8 relay outputs a 4-pipe system can only be controlled with a single fan coil channel. As soon as two fan coil channels are set in the ETS, the use of a 4-pipe system is excluded. Thus control of two fan coil units via a single fan coil actuator is only possible with a 2-pipe system.

The modes of operation (individual operation, combination operation) and the fan coil system being controlled are configured in the ETS in the common parameter "Type of fan coil system". In two-channel operation the parameter setting is made separately for each fan coil channel.

- i** The functional principles of the individual fan coil systems are described in greater detail in the following.

Fan coil system types "2-pipe only heating" and "2-pipe only cooling" (individual modes of operation):

In this type of fan coil system the fan coil actuator can either heat or cool in a single individual

mode of operation. There is thus no option of changing between heating and cooling.

The actuator receives a command value via the bus and controls its valve output and its fan level outputs based on this specification. The valve connected to the valve output closed when the command value is "0". Likewise the valve opens when the command value is greater than "0".

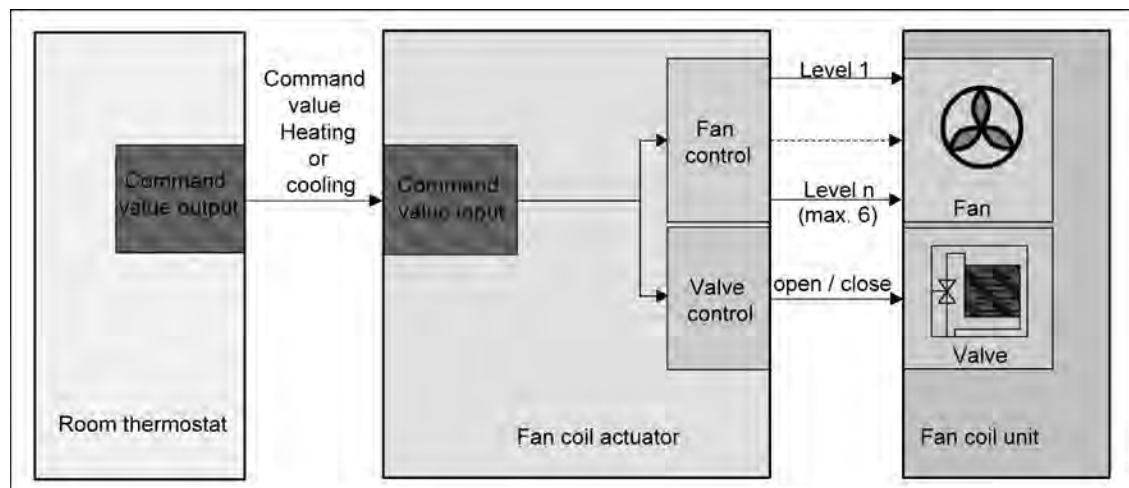

Figure 12: Functional diagram for "2-pipe only heating" and "2-pipe only cooling"

Fixed output assignment for the valve in fan coil system type "2-pipe only heating" and "2-pipe only cooling":

- with only one fan coil channel: Valve on output 1,
- with two fan coil channels: Valve on output 1 (for channel 1) and output 5 (for channel 2),
- note for one fan coil channel: Output 2 is always unused.

- i** A valve output for heating also switches on in accordance with a new command value specification even when no fan level is activated yet due to an optional switch-on delay. This prevents cold air from flowing out at the beginning of the heating process. Similarly a valve output for cooling also switches off in accordance with a new command value specification even when the fan is still activated due to an optional switch-off delay. This prevents freezing of the cooling register at the end of the cooling process.
- i** In this type of fan coil system relay output 2 is always unused in single-channel operation. Thus this output cannot be selected in manual control.
- i** The types "2-pipe only heating" and "2-pipe only cooling" can be configured in either single-channel operation or in two-channel operation.

Type of fan coil system "2-pipe heating/cooling via change-over object" and "4-pipe heating/cooling via change-over object" (combination modes of operation):

In this type of fan coil system the fan coil actuator can either heat or cool in a the combination mode of operation. Change-over of the mode of operation is performed via the communication object "Heating/cooling changeover", which exists for each fan coil channel. The source of the telegram for mode of operation change-over can be either any desired central switching point (e.g. building HVAC controller) or a room thermostat, from which the command values are also generated.

The actuator receives two independent command values via the bus. Which of these two command values is evaluated is decided by the last valid mode of operation set (heating or cooling). The command value object not evaluated in this connection is ignored until there is a change-over to its associated mode of operation.

As soon as a new mode of operation is specified via the object "Heating/cooling change-over", the actor resets both command values internally to "0" and also initially switches all of the outputs of the channel off. Only a new command value telegram subsequently received of the active mode of operation will cause the actuator to switch its relay outputs on again accordingly. Resetting of the internal command values is not performed if telegram update in accordance with the mode of operation already active (e.g. heating heating) is received via the object "Heating/cooling change-over".

The telegram polarity of the object for mode of operation change-over has a fixed definition according to the KNX data point type coding "1.100" as "0 = cooling / 1 = heating".

- i** When there is a mode of operation change-over the actuator initially switches its fan level outputs completely off, if they are switched on, and taking into account the level change-over and any switch-off delay if necessary. This is also performed if a new command value telegram was received immediately after a change-over of the mode of operation. The valves are closed during the switch-off procedure. Only after the fan has been switched off does the actuator open the corresponding valve and switches the fan back on at the required level (taking any switch-on level into account if necessary), assuming that a new command value has been received.

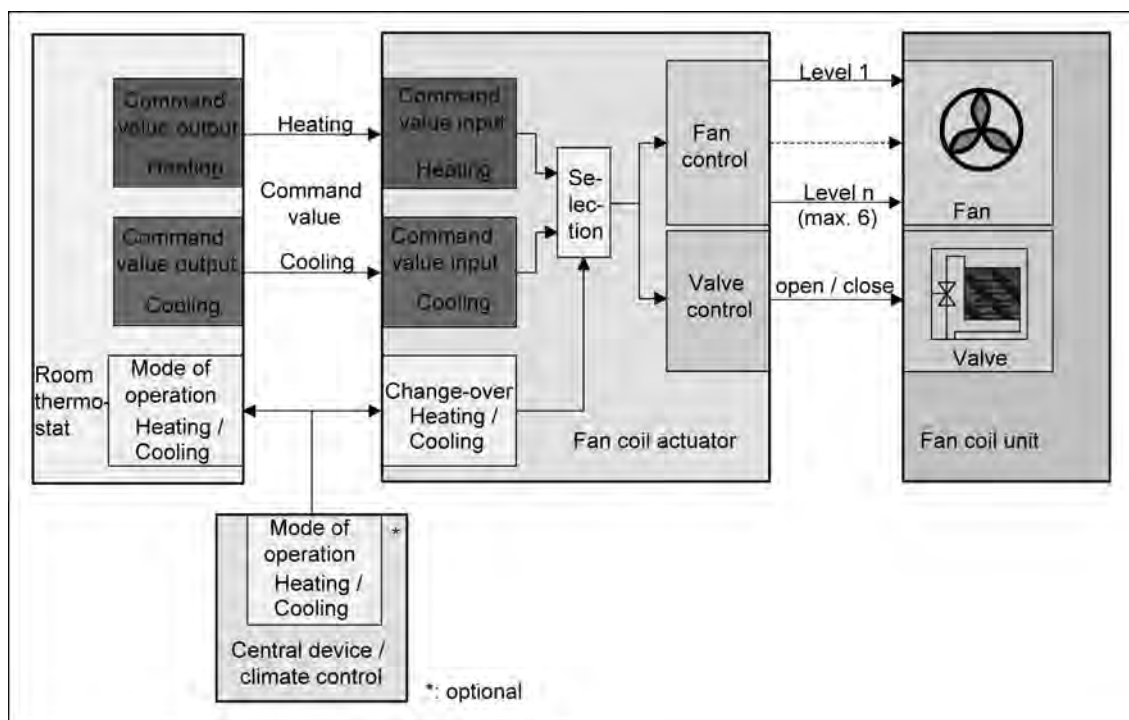

Figure 13: Functional diagram for "2-pipe heating/cooling via change-over object"

In the system "2-pipe heating/cooling via change-over object", the valve for combined heating and cooling which is connected to the valve output closes if the command value of the active mode of operation is equal to "0". Likewise the valve opens when the command value is greater than "0".

Fixed output assignment for the combined valve in fan coil system type "2-pipe heating/cooling via change-over object".

- with only one fan coil channel: valve on output 1,

- with two fan coil channels: valve on output 1 (for channel 1) and output 5 (for channel 2),
- note for one fan coil channel: Output 2 is always unused.

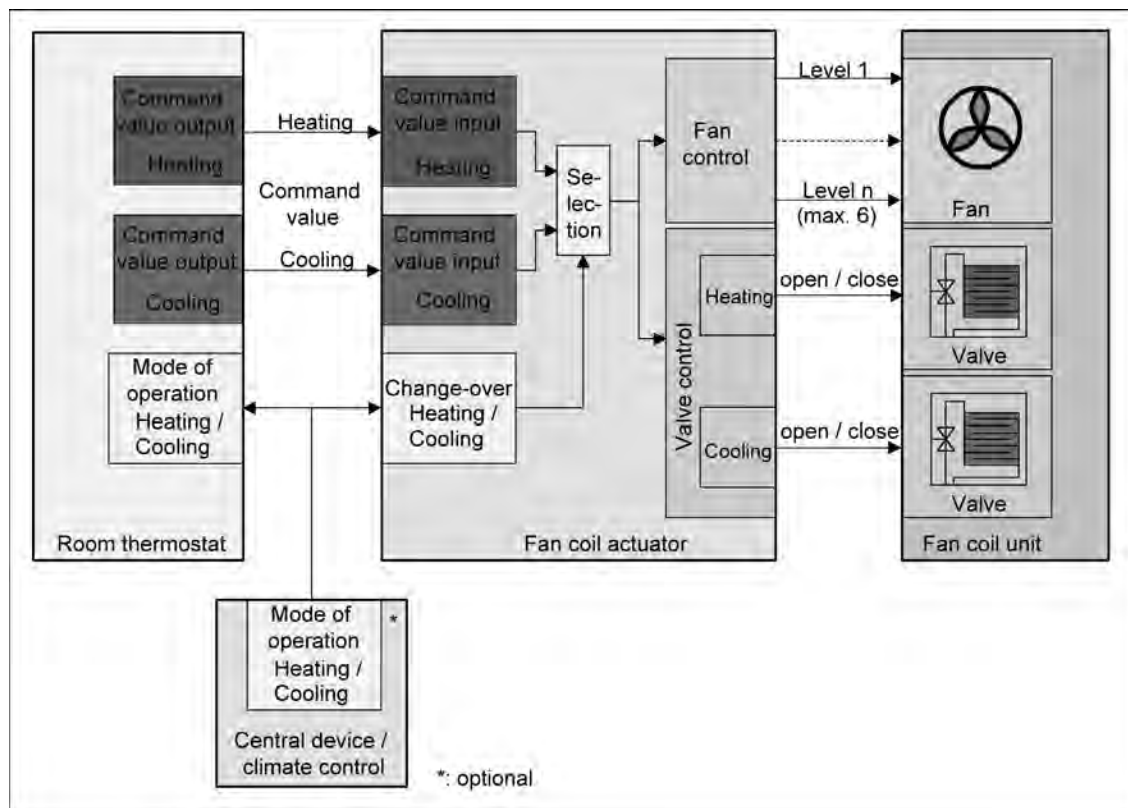

Figure 14: Functional diagram for "4-pipe heating/cooling via change-over object"

In the system "4-pipe heating/cooling via change-over object" the separate valves for heating and cooling which are connected to the valve outputs close if the command value of the associated mode of operation is equal to "0". Likewise the valve opens when the command value is greater than "0". In this application the fan coil actuator ensures that the valves are mutually interlocked, thus preventing simultaneous heating and cooling.

Fixed output assignment for the valves in fan coil system type "4-pipe heating/cooling via change-over object".

- Valve for cooling on output 1 and valve for heating on output 2.

i A valve output for heating also switches on in accordance with a new command value specification even when no fan level is activated yet due to an optional switch-on delay. This prevents cold air from flowing out at the beginning of the heating process. Similarly a valve output for cooling also switches off in accordance with a new command value specification even when the fan is still activated due to an optional switch-off delay. This prevents freezing of the cooling register at the end of the cooling process.

After a device reset (restart after any ETS programming or switching the device power supply on again e.g. due to bus voltage return), the status of the object "Heating/cooling change-over"

is always invalid. In this situation the fan coil actuator expects a telegram update to this object. Only after a mode of operation telegram is received is the command value considered by the fan coil actuator. If there has still been no update to the object "Heating/cooling change-over", the valve and fan outputs of the channel concerned remain switched off. After a device reset, received command value telegrams are saved and tracked as soon as a mode of operation is specified via the object.

- i** In operation when there is a change in the mode of operation the fan coil actuator only switches the valve and fan level outputs on again when it has received a new command value for the active mode of operation after the change. However, some KNX/EIB room thermostats may in some circumstances only transmit the telegram for change-over of the mode of operation only after they have transmitted the telegram for the command value of the new mode of operation. In such a situation, the result is that the fan coil actuator does not switch on its valve and fan level outputs immediately after the change of the mode of operation in accordance with the new command value, but rather only when the thermostat transmits a further command value in accordance with its control characteristic. In order to prevent unnecessary delays in room thermostat functions, the room thermostats concerned should always transmit their command values cyclically in addition to transmitting when there is a change.

In the case of an initialisation, for example after a bus reset, some room thermostats do not automatically transmit a telegram for the active mode of operation. Therefore the fan coil actuator would also not react to incoming command values. In order to avoid this state, the fan coil actuator can, during its own initialisation after a device reset or after a bus voltage return, generate a read request to the transmitting group address of the object "Heating/cooling change-over", and transmit it to the bus.

A "connected" room thermostat could then answer this read request with a mode of operation telegram (set R-flag on thermostat object!). After that, the fan coil actuator would work and evaluate command value telegrams according to the mode of operation received back from the thermostat. If no response is received to the read request, then the mode of operation remains undefined.

Because room thermostats or building HVAC controllers generally themselves require some time after a bus reset to initialise themselves and to determine the mode of operation, the read request of the fan coil actuator can be delayed by up to 59 s.

Both the read request and the delay time can be configured in the ETS separately for each fan coil channel only in the types "2-pipe heating/cooling via change-over object" and "4-pipe heating/cooling via change-over object".

- i** In the type of fan coil system "2-pipe heating/cooling via change-over object", relay output 2 is always unused in single-channel operation. Thus this output cannot be selected in manual control.
- i** The type "2-pipe heating/cooling via change-over object" can be configured in either single-channel operation or in two-channel operation. The type "4-pipe heating/cooling via change-over object" can be configured only in single-channel operation.

Fan coil system type "4-pipe heating/cooling via command value specification" (combination mode of operation):

In this type of fan coil system the fan coil actuator can either heat or cool in a the combination mode of operation. The change-over of the mode of operation is performed directly via the command value objects of a fan coil channel. There is no separate communication object for the change-over.

The actuator receives two independent command values for heating and cooling via the bus. The actuator decides independently based on the last command value received which mode of operation and which valve position and fan level must therefore be used.

The mode of operation is changed, however, only when a command value not equal to zero is received. What is decisive for changing to a mode of operation is which of the command values not equal to zero was received last, and not its absolute value. If both command values are equal to zero, the actuator switches all valve and fan level outputs off (after any fan switch-off delay has elapsed, if necessary), and remains internally in the last valid mode of operation set.

Example 1:

The actuator is in heating operation and is heating with a command value of 100%. Then a command value telegram for cooling with a command value of 75% is received. As a result, the fan coil actuator switches to cooling operation and cools with a command value of 75%.

Example 2:

The actuator is in cooling operation and is cooling with a command value of 75%. Then a command value telegram for heating with 0% is received. As a result, the fan coil actuator remains in the mode of operation cooling and continues to cool with a command value of 75%.

Example 3:

The actuator is in cooling operation and is cooling with a command value of 75%. The command value for heating was last specified at 0%. Then a command value telegram for cooling with 0% is received. As a result the fan coil actuator switches all of its outputs of the fan coil channel concerned off and waits for new command values.

- i** When there is a mode of operation change-over the actuator initially switches its fan level outputs completely off, if they are switched on, and taking into account the level change-over and any switch-off delay if necessary. Both valves are also closed during the switch-off procedure. Only after the fan has been switched off does the actuator open the valve of the new mode of operation and switches the fan back on at the required level (taking any switch-on level into account if necessary).
- i** A change in the mode of operation also takes place if the command value does not reach the lower limit for the first fan level parameterised in the ETS.
- i** The actuator always executes newly received command value telegrams of the active mode of operation (e.g.. heating 75 % to heating 50 % = heating is performed with the new command value 50 %).

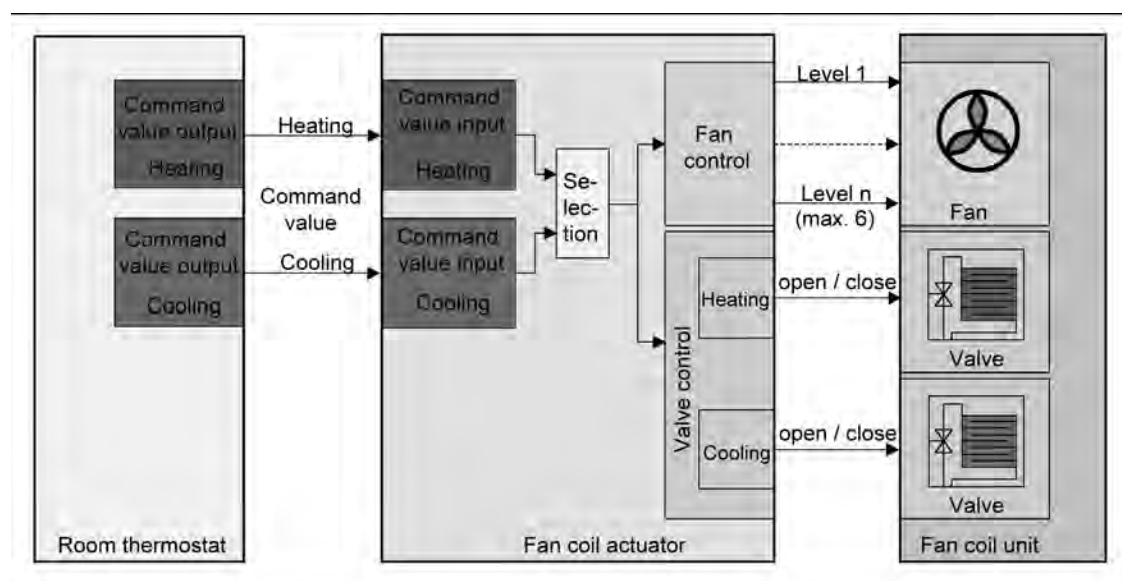

Figure 15: Functional diagram "4-pipe heating/cooling via command value specification"

In the system "4-pipe heating/cooling via command value specification" the separate valves for heating and cooling which are connected to the valve outputs close if the command value of the associated mode of operation is equal to "0". Likewise the valve opens when the command value is greater than "0". In this application the fan coil actuator ensures that the valves are mutually interlocked, thus preventing simultaneous heating and cooling.

Fixed output assignment for the valves in fan coil system type "4-pipe heating/cooling via command value specification".

- Valve for cooling on output 1 and valve for heating on output 2.

i A valve output for heating also switches on in accordance with a new command value specification even when no fan level is activated yet due to an optional switch-on delay. This prevents cold air from flowing out at the beginning of the heating process. Similarly a valve output for cooling also switches off in accordance with a new command value specification even when the fan is still activated due to an optional switch-off delay. This prevents freezing of the cooling register at the end of the cooling process.

i The type "4-pipe heating/cooling via command value specification" can be configured only in single-channel operation.

Setting the type of fan coil system

After the number of fan coil channels has been set, the type of the fan coil system must be set in the ETS. The setting for the fan coil system is performed separately for each fan coil channel. The fan coil system determines in what modes of operation (heating or cooling) the actuator works, how change-over takes place in the mixed mode of operation "heating/cooling", and also defines whether a 2-pipe or a 4-pipe system is being controlled.

The number of required fan coil channels must have been set already.

- Set the parameter "Type of fan coil system" on the parameter page "General" to "2-pipe only heating".

The fan coil channel concerned can only heat. The heating energy is supplied to the connected fan coil unit via a 2-pipe system (= 1 valve for heating).

- Set the parameter "Type of fan coil system" on the parameter page "General" to "2-pipe only cooling".

The fan coil channel concerned can only cool. The cooling energy is supplied to the connected fan coil unit via a 2-pipe system (= 1 valve for cooling).

- Set the parameter "Type of fan coil system" on the parameter page "General" to "2-pipe heating/cooling via change-over object".

The fan coil channel concerned can either heat or cool. Which of these modes of operation is active is controlled by a 1-bit change-over object. The heating or cooling energy is supplied to the connected fan coil unit via a combined 2-pipe system (= 1 valve for heating and cooling).

The following settings can only be selected for "Number of fan coil channels = 1"...

- Set the parameter "Type of fan coil system" on the parameter page "General" to "4-pipe heating/cooling via change-over object".

The fan coil channel concerned can either heat or cool. Which of these modes of operation is active is controlled by a 1-bit change-over object. The heating or cooling energy is supplied to the connected fan coil unit via a divided 4-pipe system (= 1 valve for heating and 1 valve for cooling).

- Set the parameter "Type of fan coil system" on the parameter page "General" to "4-pipe heating/cooling via command value specification".

The fan coil channel concerned can either heat or cool. Which of these modes of operation is active is determined by the last command value received (not equal to "0"). The heating or cooling energy is supplied to the connected fan coil unit via a divided 4-pipe system (= 1 valve for heating and 1 valve for cooling).

The following settings must additionally be made only in "Type of fan coil system = via change-over object"...

- Set the parameter "Read request to object 'Heating/cooling change-over'?" on the parameter page "Channel x general" (x = number of the fan coil channel) to "Yes", if a read request is to be transmitted to the bus after a device reset. Otherwise set to "No" (default setting).

When the setting is "Yes", immediately after its initialisation the fan coil actuator transmits a read request (ValueRead) to the group address of the object "Heating/cooling change-over". The corresponding value feedback, e.g. of a room thermostat, then specifies a valid mode of operation to the actuator. The setting "No" deactivates the read request. In this case the fan coil actuator waits after a reset for a new telegram for mode of operation change-over.

- Only for "Read request to object 'Heating / cooling change-over'? = Yes": Additionally configure the parameter "Delay time for read request" to the required time.

After a device reset the fan coil actuator waits for the specified time (0 s...59 s) until it transmits the read request via the object "Heating / cooling change-over". With the setting "0 s" the actuator does not wait and transmits the read telegram to the bus immediately after its own initialisation. This initialisation time of approx. 5 s is always in effect (even when the delay for read request is deactivated), and thus adds itself to the time set in the ETS.

The "Delay after bus voltage return" set in the ETS has no effect on the read request!

- i** The parameters for the fan coil system should be set at the beginning of the device parameterisation right after the number of fan coil channels has been defined, because all further channel-oriented parameters are dependent on this setting. If the parameters are only changed during the course of a device configuration, the assignments of group addresses to objects could be lost or parameter settings could be reset!
- i** In the ETS parameterisation, the parameter page "Connection help for output assignment" shows the functions of the up to 8 outputs in accordance with the parameter settings.

4.2.4.2.2 Delay after bus voltage return

Delay after bus voltage return

In order to reduce the telegram traffic on the bus line after the bus voltage is switched on (bus reset), after connection of the device to the bus line or after ETS programming it is possible to delay all of the actively transmitting feedback or status messages of the actuator. For this purpose a channel-independent delay time can be defined (parameter "Delay after bus voltage return" on the parameter page "Times". Only after the parameterised time elapses are feedback or status telegrams for initialisation transmitted to the bus.

The feedback objects "active fan level" and "fan coil active", the status of the manual control, the fault message for cyclical monitoring and the feedback for the manual fan control can be transmitted to the bus with a delay, so long as these feedback telegrams are enabled in the ETS. If so enabled, the status information of the manual control, the fault message of the cyclical monitoring and the feedback for the manual fan control are always transmitted, taking the preset delay into account. The feedback telegrams "active fan level" and "fan coil active" can be transmitted to the bus either immediately or with a delay, depending on their parameterisation.

The delay time can be set between 0 seconds (no delay; immediate telegram transmission after readiness of the fan coil actuator) and 59 minutes 59 seconds (maximum delay). When multiple fan coil actuators are used in a single KNX/EIB installation, it is advisable to set different delay times for the individual devices.

After a device reset the fan coil actuator always requires a short initialisation time before it is ready to function. This initialisation time of approx. 5 s is always in effect (even when the delay after bus voltage return is deactivated), and thus adds itself to the time set in the ETS.

- i** The delay has no effect on the behaviour of the outputs. Only the feedback telegrams or status telegrams are delayed. The outputs are not locked during this time and can also be activated during the delay after bus voltage return.
- i** Also no request telegrams for the feedback telegrams are answered during the delay time.
- i** The delay time after bus voltage return has no effect on read requests for mode of operation change-over. A separate delay time can be configured in the ETS for this purpose.

4.2.4.2.3 Manual control

Manual control

The fan coil actuator has a manual control function for all valve, fan level or switching outputs. The button field with 4 function keys and 3 status LEDs on the front panel of the device (figure 16) can be used for setting and controlling the following modes of operation...

- Bus operation: operation from other bus devices (e.g. room thermostats, push-buttons, etc.),
- Temporary manual control: manual control via the button field, automatic return to bus operation,
- Permanent manual control: exclusively manual control of the device via the button field, return to bus operation only after manual control is aborted manually.

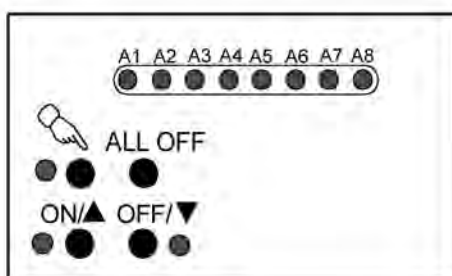

Figure 16: Elements for manual control on the front panel of the device

The operation of the function keys, the control of the individual outputs and the status display are described in detail in chapter "2.5 Operation".

The parameterisation, status feedback, disabling via a bus telegram, and interaction with other functions of the fan coil actuator when manual control is activated and deactivated are described in greater detail below.

Manual control is possible only while the actuator is supplied with power from the mains. In the state of the fan coil actuator as supplied, manual control mode is fully enabled. In this unprogrammed state the individual outputs can be switched on and off even without the bus voltage being connected, which allows quick function checks of the connected fan coil devices or other loads, for example at building sites.

After initial commissioning of the actuator via the ETS, manual control can be enabled or disabled separately for various states of operation. Manual control can, for instance, be disabled during bus operation (bus voltage applied). It is also possible to completely disable manual control in the event of a bus voltage failure. Therefore manual control can be disabled completely, if the bus disable and bus failure disable are active.

Enabling the manual control mode

Manual control for the different states of operation is enabled by means of the parameters "Manual control in case of bus voltage failure" and "Manual control during bus operation".

- Set the parameter "Manual control in case of bus voltage failure" to "enabled".
Manual control is then basically enabled when the bus voltage is off. This setting corresponds to the setting of the actuator as delivered.
- Set the parameter "Manual control in case of bus voltage failure" to "disabled".
Manual control is completely disabled when the bus voltage is off. In this case, bus operation is not possible either so that the outputs of the actuator can no longer be activated.

- i** In the configuration "Manual control in case of bus voltage failure = disabled", a bus voltage failure does not terminate a previously activated manual control. In this case, the parameter configuration only takes effect when the manual control is terminated by pressing a button on the device. After that the manual control cannot be activated as long as the bus voltage is switched off.

- Set the parameter "Manual control during bus operation" to "enabled".
Manual control is then basically enabled when the bus voltage is on. The outputs of the actuator can be activated via the bus or manually. This setting corresponds to the setting of the actuator as delivered.
 - Set the parameter "Manual control during bus operation" to "disabled".
Manual control is completely disabled when the bus voltage is on. In this configuration, the actuator outputs can only be operated via the bus.

- i** Further parameters and communication objects of the manual control are visible only in the configuration "Manual control during bus operation = enabled". For this reason, the disabling function, the status message and bus control disabling can only be configured in the above parameter setting.

Presetting the behaviour at the beginning and at the end of manual control

The manual control distinguishes the temporary and permanent manual control. The behaviour is different depending on these modes of operation, especially at the end of manual control. It should always be noted that bus operation is always disabled while manual control is active. Manual control of the outputs of the actuator has the second-highest priority. Only the dwell time (pause time) for a level change-over has a higher priority, and is always retained even in case of manual control. If so programmed in the ETS, the switch-on level also initially overrides the one preselected manually when any fan level is switched on for the first time.

Behaviour at the beginning of manual control:

The behaviour at the beginning of manual control does not differ for temporary and permanent manual control. At the beginning of manual control, initially the last activated switching states of the valve outputs and of the simple switching states, and also the states of the fan levels, are adopted without change. Active disabling functions or fan levels can be overridden by manual control. These functions, as well as all other functions with a lower priority than manual control, are activated again after manual control is terminated, as long as they were not deactivated in the meantime. Then the function with the higher priority is always executed (see chapter 4.2.4.4. Priorities).

- i** Valve protection must be considered separately: If a valve is to be switched on as a result of its protection function being executed, then the valve output is switched off immediately at the beginning of manual control. This is necessary to prevent overheating or freezing without ventilation of any valve that may have been switched off before by the valve protection.

Behaviour at the end of manual control:

The behaviour at the end of manual control is different for temporary and permanent manual control.

Temporary manual control is switched off automatically as soon as the last output has been selected and the selection button  is pressed another time, or no button is pressed for 5 s. When temporary manual control is switched off the actuator returns to "normal" bus operation and does not change the status last set via manual control. If, however, a disabling function or fan level limitations or other functions with a lower priority than manual control, but a higher priority than normal operation (bus operation via command values and mode of operation

change-over) has been activated via the bus before or during manual control, then the actuator executes these functions again for the fan coil channels concerned.

Permanent manual control is switched off if selection button  is pressed for longer than 5 s. Depending on the parameterisation of the actuator in the ETS, when permanent manual control is switched off the outputs are set to the state last set via manual control or internally tracked (for fan coil devices: disabling functions, fan level limitations, valve/fan protection, cyclical monitoring, etc.). The parameter "Behaviour at the end of permanent manual control during bus operation" defines the corresponding reaction.

- Set the parameter "Behaviour at the end of permanent manual control during bus operation" to "no change".

All telegrams received while permanent manual control is active (e.g. command value telegrams, telegrams for mode of operation change-over or for activation of a disabling function or fan level limitation or switching telegram of the simple switching outputs) will be rejected. After the end of the permanent manual control mode, the current state of all outputs remains unchanged.

If, however, a disabling function, a level limitation or manual fan control or other functions with a lower priority than manual control, but a higher priority than normal operation (bus operation via command values and mode of operation change-over) has been activated via the bus before or during manual control, then the actuator executes these functions again for the fan coil channels concerned.

- Set the parameter "Behaviour at the end of permanent manual control during bus operation" to "track output states".

During active permanent manual control all incoming bus telegrams are tracked internally. At the end of manual control, all outputs are adjusted to the tracked states. The individual priorities of the functions with respect to one another are taken into account here; in each case only the function with the higher priority is executed (see chapter 4.2.4.4. Priorities). If during manual control no bus telegrams are received, the internally tracked state corresponds to the state before the manual control.

- i** When the setting is "No change" (in temporary manual control always, in permanent manual control in accordance with the parameterisation), the following applies for fan coil systems with mix mode of operation heating/cooling: The valve outputs can be switched as desired via manual control. It is also possible to change the mode of operation via manual control (heating <-> cooling). In normal operation, with the setting "no change" the last mode of operation set via manual control remains active. This overrides the mode of operation last specified via the bus.
Only after either a mode of operation change-over or a new command value for the mode of operation last specified via the bus is received does the actuator restore the bus mode of operation state. As is usual with a change-over of the mode of operation, a switch-on or switch-off delay and a switch-on level of the fan is taken into account here if necessary.
- i** The behaviour at the end of the permanent manual control when the bus voltage is off (only manual control) is permanently set to "no change".
- i** The control operations triggered during manual control update the states of the objects "Feedback for active fan level" and "Feedback for fan coil active". Telegrams are also transmitted to the bus, if the feedback objects concerned are enabled in the ETS and are parameterised as actively transmitting.

- i** Manual control is possible only while the actuator is supplied with power from the mains. The bus supply voltage does not have to be connected or switched on (building site operation).
In the event of a bus voltage failure, manual control is automatically terminated and all relays are switched off. The parameterised "Behaviour at the end of permanent manual control" is not carried out here.
In case of bus voltage return, active manual control is automatically terminated and the actuator executes the "Behaviour after bus or mains voltage return".
Failure of the bus voltage when the mains voltage supply is switched on does not end manual control. In this case the actuator does not execute the "behaviour in case of bus voltage failure" configured in the ETS.
At the beginning of any ETS programming process, manual control is terminated automatically. Manual control cannot be activated or continued during an ETS programming process.

Presetting a manual control disable

The manual control mode can be separately disabled via the bus, even if it is already active. If the disabling function is enabled, then as soon as a disabling telegram is received via the disabling object of the manual control, the actuator immediately terminates an activated manual control and locks the function keys on the front panel of the device. The telegram polarity of the disabling object is parameterisable.

The manual control mode during bus operation must be enabled in the ETS.

- Set the parameter "Disabling function ?" on parameter page "Manual control" to "yes".
The disabling function of the manual control mode is enabled and the disabling object is visible.
 - Select the desired telegram polarity in the "Disabling object polarity" parameter.
- i** If the polarity is "0 = disabled; 1 = enabled", the disabling function is immediately active on return of bus voltage or after an ETS programming operation (object value "0"). To activate the manual control in this case, an enable telegram "1" must first be sent to the disabling object.
- i** In case of bus voltage failure the disabling via the disabling object is always inactive (manual control is then either enabled or completely disabled in accordance with the parameter "Manual control in case of bus voltage failure". After return of bus voltage a disabled state that was active before will be reactivated.
- i** In the event of failure of the supply voltage (bus voltage and mains voltage failure) the disable is deactivated via the disabling object. Merely the interruption of the mains voltage supply does not affect the disabling of manual control.
- i** When an active manual control is terminated by a disable, the actuator will also transmit a "Manual control inactive" status telegram to the bus, if this status messaging function is enabled.

Presetting the status message function for the manual control mode

The actuator can transmit a status message to the bus via a separate object, when the manual control mode is activated or deactivated. The status telegram can only be transmitted when the bus voltage is present. The polarity of the status telegram can be parameterised.

The manual control mode during bus operation must be enabled in the ETS.

- Set the parameter "Transmit status ?" on the "Manual control" parameter page to "yes".
The status messaging function of manual control is enabled and the status object is visible.
 - Specify in the parameter "Status object function and polarity" whether the status is generally transmitted as a "1" telegram whenever manual control is activated, or only when permanent manual control is activated.
- i** The status object is always "0" when the manual control mode is deactivated.

- i** After bus voltage return, in accordance the the state of the manual control the status object is always updated and transmitted actively to the bus. This transmission of the status telegram is performed with a time delay, if necessary, depending on the parameter setting for the "Delay after bus voltage return" on the parameter page "Times".
Manual control is terminated by a mains voltage failure or ETS programming. In case of a bus voltage failure a status telegram "OFF" is transmitted, if the bus voltage is switched on at that instant. The current status is also transmitted after ETS programming.
- i** When active manual control is terminated by a disable, the actuator will also transmit a "Manual control inactive" status telegram to the bus.

Setting disabling of the bus control

The fan coil channels or the simple switching outputs – if present – can be disabled locally by means of manual control on the device, so that the outputs concerned can no longer be activated by means of bus telegrams. Such disabling of the bus operation is initiated by operation in permanent manual control and is indicated by rapid flashing of the status LEDs (A1...A8) of the outputs concerned. The disabled outputs of a fan coil channel or of the simple switching outputs can then only be activated in permanent manual control.

The manual control mode during bus operation must be enabled in the ETS.

- Set the parameter "Bus control of the channels during bus operation can be disabled?" on parameter page "Manual control" to "yes".

The function for disabling the bus control is enabled and can be activated locally. As an alternative, this parameter can be set to "no" to prevent activation of disabling of the bus control in permanent manual control.

- i** The disabling initiated locally has the highest priority. Thus all other functions of the actuator that can be activated via the bus (e.g. disabling function, fan protection, and the like), are overridden. The bus-disabled output remains in the state last set in permanent manual control.
Depending on the parameterisation of the actuator in the ETS, at the end of the bus disabling and subsequent switching-off of the permanent manual control, the outputs will be set to the state last set via manual control or to the state internally tracked. If necessary any active fan level limitation will also be executed here.
If, however, a disabling function or manual fan control has been activated via the bus before or during the bus disabling, the actuator executes these functions again for the fan coil channels concerned.
- i** Any disabling of the bus control activated locally is not reset in case of bus voltage failure or return. Even a mains voltage failure does not by itself reset the disabling. A failure of the supply voltage (bus and mains voltage failure) does, however, deactivate the disabling of the bus control.

4.2.4.3 Channel-oriented functional description

4.2.4.3.1 Reset and initialisation behaviour

Behaviour in case of bus voltage failure, after bus or mains voltage return or after programming with the ETS

The behaviour of the fan coil actuator after bus or mains voltage return can be set separately in the ETS for each fan coil channel. Because the actuator is equipped with mains-supplied, monostable relays, it is also possible to configure the relay switching state in case of bus voltage failure.

Behaviour after ETS programming

After any programming via the ETS, all valve and fan level outputs of the fan coil actuator are always opened (OFF state). The relays of the simple switching outputs, if present, also open. The behaviour after ETS programming is thus specified as a fixed value, and cannot be adjusted.

- i** ETS programming can be performed as soon as the bus voltage is connected to the actuator and switched on. The mains voltage supply is not required for an ETS download.
- i** After ETS programming, the disabling functions and the level limitations are always deactivated. The manual fan controls are deactivated, so long as their parameterisation does not call for any activation (parameter "Activate manual fan control after bus or mains voltage failure? = no"). The checking time intervals of the valve and fan protection are reset and restarted.
- i** After ETS programming the feedback and status objects of the actuator are updated. As a part of this, if necessary the actuator transmits the following feedback telegrams (if transmitting actively) and status telegrams (if enabled in the ETS) to the bus after the delay time has elapsed:
 - for each fan coil channel: "Feedback for fan coil active" and "Feedback for active fan level",
 - the status of manual control,
 - the feedback telegrams of the manual fan controls,
 - the status messages of the cyclical monitoring functions.
- i** At the beginning of any ETS programming process, manual control is terminated automatically. Manual control cannot be activated or performed during an ETS programming process.
- i** For manual fan control:
Activation of manual fan control after ETS programming can be forced by means of parameter configuration in the ETS (see chapter 4.2.4.3.6. Manual fan control).

Presetting the behaviour in case of bus voltage failure

The behaviour of a fan coil channel is set via the parameter "Behaviour in case of bus voltage failure" on the parameter page "Channel x general" (x = number of the fan coil channel).

- Set parameter to "Switch off all valve & fan outputs".
In the event of a bus voltage failure, all valve and fan outputs of the actuator are switched off. Switch-off delays set for fan levels are not taken into consideration here. If the fan levels are controlled using the level principle, switching-off is performed in stages taking into account the dwell time in the level change-over.
- Set parameter to "no change in the valve & fan states".
In the event of a bus failure, all valve and fan relay states remain unchanged (see notes). So long as the actuator remains supplied with mains voltage in this state, dwell times or pause times for a previously executed level change-over or switch-on level will be processed (higher priority), after which the intended "target state" of the fan will be set.

i To protect against overheating of the heating register or freezing of the cooling register of a fan coil unit, the valves are switched off by forced control in the event of a bus failure that occurs during the dwell time or pause time of a level change-over. This is always performed, independently of the fan coil system set in the ETS. The valves can be switched on at any time with subsequent bus or mains voltage return or via manual control.

i If any switch-on or switch-off delays for the fans were active at the instant of a bus voltage failure, the actuator aborts their processing. With the setting "no change in the valve & fan states" the fan coil actuator then creates the intended "target state" of the delay immediately.

i In the event of a failure of the mains voltage supply, all relays of the actuator always drop out (contacts open), regardless of the state of the bus voltage. In this state the outputs can no longer be activated.

Because in this situation all valves and fans are switched off, the fan coil actuator updates its feedback telegrams "active fan level" and "fan coil active" accordingly (state "OFF" / "inactive") and also transmits the telegrams to the bus, so long as bus voltage is present and the objects are configured as actively transmitting. These feedback telegrams are then also sent cyclically, so long as bus voltage is present. The actuator also sends a status telegram "Manual control inactive" to the bus if manual control was aborted by the mains failure.

A change of state via the bus (e.g. a newly-received command value, manual fan control or a level limitation) is ignored by the actuator in the event of a mains failure, and is thus not executed. A request for feedback is also not answered by the actuator in the event of a mains voltage failure. Read telegrams (ValueRead) are always answered, so long as the bus voltage is switched on.

i In the event of a bus or mains voltage failure the temporary application data of all fan coil channels are saved internally in non-volatile memory, which means that these data can be restored after bus or mains voltage return, if this is parameterised in the ETS (cf. "Presetting the behaviour after bus or mains voltage return").

The data are stored before the reaction parameterised for the case of bus voltage failure takes place and only if one part of the supply (mains or bus) is still present, or if the supply fails completely after the mains voltage has been available before without interruption for at least 20 seconds after the last reset (storage capacitors sufficiently charged for storage purposes). In all other cases nothing is stored.

The following application data are saved separately for the up to two fan coil channels...

- command values for heating and cooling,
 - the state set after the end of a cyclical monitoring time,
 - an activated level limitation,
 - activated manual fan control, including level value,
- Any active fan or valve protection or disabling function is not saved.

The saving process is performed only once after the failure of one part of the supply voltage...

Example 1:

Bus voltage failure -> saving process -> then mains voltage failure -> no additional saving process,

Example 2:

Mains voltage failure -> saving process -> then bus voltage failure -> no additional saving process.

Because the application data are saved only once in the event of bus or mains voltage failure, values or states that are changed after a bus voltage failure, for example via manual control, or in the event of a mains voltage failure via bus operation, are not tracked!

In case of ETS programming, the saved application data are lost (see "Behaviour after ETS programming").

i Any manual control previously activated is terminated automatically in the event of a mains voltage failure. In this case, the parameterised "Behaviour at the end of permanent manual control during bus operation" is not executed. Failure of only the bus voltage when the mains voltage supply is switched on does not end manual control.

- i** Active disabling functions are always cancelled by a bus or mains voltage failure, and are subsequently inactive. The checking time intervals of the valve and fan protection and the time interval of the cyclical monitoring are likewise reset and later restarted when the supply voltage is switched on.
- i** Fan levels of a fan coil channel which are not used can optionally be used as switching outputs with a simple switching function. The behaviour of these switching outputs is determined as following in the event of a bus or mains voltage failure:
 - Behaviour in case of bus voltage failure: no reaction,
 - Behaviour in case of mains voltage failure: switch off (open contacts).

Presetting the behaviour after bus or mains voltage return

The behaviour of a fan coil channel is set via the parameter "Behaviour after bus or mains voltage return" on the parameter page "Channel x general" (x = number of the fan coil channel).

- Set parameter to "Switch off all valve & fan outputs".

In case of bus or mains voltage return, all valve and fan outputs of the actuator are switched off. If the fan levels are controlled using the level principle, switching-off is performed in stages taking into account the dwell time in the level change-over. If a switch-off delay has been configured for the fan, then it is taken into account after the cooling valve is switched off. Any switch-off delay previously started and still active is, however, aborted in case of bus or mains return, and then immediately set to the intended "OFF" state. Disabling functions or fan level limitations are deactivated. The manual fan controls are deactivated, so long as their parameterisation does not call for any activation (parameter "Activate manual fan control after bus or mains voltage failure? = no").
- Set parameter to "Valve & fan states as before bus/mains failure".

In the event of bus or mains voltage return the application data saved before bus or mains voltage failure are restored (see notes on "Presetting the behaviour in case of bus voltage failure"), and the states of the valve and fan level outputs are tracked. In case of restoration of the states of the fan level outputs, switch-on delays, switch-on levels incl. dwell times and dwell/pause times for the level change-over are taken into account. The tracked relay states are never set until the mains voltage is also present.
- i** The outputs remain set to the state after bus or mains voltage return until new command values are specified (or if necessary a mode of operation specification is received), or a new function of the actuator (disabling function, manual control, etc.) is activated.
- i** For the setting "Valve & fan states as before bus/mains failure":

For the fan coil systems "2-pipe heating/cooling via change-over object" and "4-pipe heating/cooling via change-over object", the saved state is not restored immediately. First a mode of operation has to be received via the object "Heating/cooling change-over". As long as no valid mode of operation has been specified from outside, the relay outputs of the fan coil channel concerned remain in the state OFF.
- i** For the setting "Valve & fan states as before bus/mains failure":

In case of ETS programming, the saved application data are lost. In this case, or if no application data could be saved, the actuator executes the behaviour "Switch off all valve & fan outputs".

- i** In the event of bus voltage return the feedback and status objects of the actuator are updated. As a part of this, if necessary the actuator transmits the following feedback telegrams (if transmitting actively) and status telegrams (if enabled in the ETS) to the bus after the delay time has elapsed:
- for each fan coil channel: "Feedback for fan coil active" and "Feedback for active fan level",
 - the status of manual control,
 - the feedback telegrams of the manual fan controls,
 - the status messages of the cyclical monitoring functions.
- If only the mains voltage is switched on again (bus voltage remained switched on without interruption), then the fan coil actuator only transmits the feedback telegrams "active fan level" and "fan coil active" if outputs of the channel concerned are switched on as a result of the tracking of states after mains voltage return.
- In this case the status telegram of the manual fan control is also transmitted if the mains voltage return activates the manual control of the fan (parameter-dependent).
- i** For manual fan control:
Activation of manual fan control after bus or mains voltage return can be forced by means of parameter configuration in the ETS (see chapter 4.2.4.3.6. Manual fan control). If activation of the manual fan control was forced, then the actuator does not execute the "behaviour after bus or mains voltage return" for the fan coil channel concerned.
- i** Active disabling functions are always inactive after bus or mains voltage return.
- i** Fan levels of a fan coil channel which are not used can optionally be used as switching outputs with a simple switching function. The behaviour of these switching outputs in case of bus or mains voltage return is defined as follows:
- Behaviour in case of bus voltage return: no reaction,
 - Behaviour in case of mains voltage return: same state as before mains failure, if no bus failure has occurred in the meantime; otherwise switch off (open contract).

4.2.4.3.2 Protection functions

Valve protection

The fan coil actuator can protect the valves for heating and cooling connected for each channel against sticking. The anti-sticking protection is generally necessary to prevent a valve defect if the valve drives are not moved for a prolonged time.

The valve protection of the fan coil actuator functions as follows...

Each valve has a separate 24-hour elapsed-time meter in the fan coil actuator. A meter is started after the corresponding valve is closed by the (output OFF). As soon as the valve is opened again by any function of the actuator, the actuator resets the elapsed-time meter for that valve to "0 h", and only starts the meter again when the corresponding valve is closed again.

If a valve is then not activated for a period of 24 hours (i.e. the maximum time meter level has been reached; the valve was closed for the last 24 hours), then the fan coil actuator opens the corresponding valve under forced control for a defined period of 5 minutes. In this state incoming command value telegrams or a change-over of the mode of operation have no effect on the valve position. Only after this time has elapsed will the actuator react again to new command values or mode of operation specifications.

The 24-hour time meter is always stopped and reset in the event of an active disabling function, in the event of mains or bus voltage failure, in the event of a fault (monitoring time of the cyclical monitoring elapsed), or in the event of manual control locally on the device. If the actuator is actively executing a valve protection function, i.e. a valve is open due to the protection function, then the actuator aborts the valve protection immediately if one of the above-mentioned events occurs. A failure only of the mains voltage does not reset the time meter.

Valve protection is therefore only performed in normal operation (control via the bus by means of command value telegrams - no function with a higher priority activated) when bus and mains voltage is present.

After initialisation of the actuator (after bus and mains voltage return or after ETS programming), the 24-hour time meter is reset and restarted when valve protection is enabled. The first valve protection will thus be performed 24 hours after the initialisation at the earliest.

For 4-pipe fan coil systems, the following must be taken into account in connection with valve protection: In order to avoid simultaneous heating and cooling in the fan coil unit, the respective other valve of the fan coil channel will be closed if it is open.

In this manner a fan coil unit that, for example, performs heating at a specific time, can perform cooling for the duration of the valve protection. The reverse is true in like manner. This behaviour influences the thermostat process for the room temperature for a short time.

If the 24-hour time meter for a valve elapses while valve protection is being executed for the other valve of the channel, then the valve protection for the second valve is delayed until the valve protection of the first valve is completed or aborted. After that the second valve protection is executed, so long as the bus and mains voltage is switched on.

- i** The actuator opens a valve as part of the valve protection without regard to the state of the fan. In other words, the fan can also be in the switched-off state. Valve protection and fan protection can also be executed at the same time, however.
- i** If the actuator energizes a valve output as part of the valve protection, then - if so enabled - the feedback "Fan coil active" is updated and if necessary sent to the bus.
- i** The valve protection is also executed if after a device reset (bus voltage return or ETS programming) no mode of operation has been specified.

- i** In manual control: If a valve is to be switched on as a result of its protection function being executed, then the valve output is switched off immediately at the beginning of manual control. This is necessary to prevent overheating or freezing without ventilation of any valve that may have been switched off before by the valve protection.

Enabling valve protection

Valve protection can be enabled separately for each fan coil channel.

- Set the parameter "Valve protection" on the parameter page "Channel x - general" (x = number of the fan coil channel) to "cyclically 24h after last valve position".
The valve protection is enabled. The 24-hour meter is started automatically after initialisation of the actuator. If a valve is not actuated for a period of 24 hours, then the actuator opens the corresponding valve for a period of 5 minutes. This process is repeated cyclically every 24 hours, so long as in the meantime no valve activation is performed via command values, via a disabling function, or via manual control.
- Set the parameter "Valve protection" on the parameter page "Channel x - general" to "deactivated".
The valve protection is completely deactivated.

Fan protection

The fan coil actuator can protect the connected fan motors against sticking, and the fan blades and the heat exchanger of the fan coil unit against dust. This protection function is generally necessary to prevent a fan defect if the fan has not been moved for a prolonged time.

The fan protection of the fan coil actuator functions similarly to the valve protection as follows...

Each fan has a separate 24-hour elapsed-time meter in the fan coil actuator. A counter is started when all of the outputs belonging to a fan are switched off by the actuator. As soon as at least one fan level output is switched on again by any function, the actuator resets the time meter for the corresponding fan to "0 h" and only starts the meter again when all fan level outputs are switched off again.

If all fan level outputs of a channel are then not switched on again for a period of 24 hours (i.e. the maximum time meter level has been reached; the fan was not in motion in the last 24 hours), then the fan coil actuator switches the corresponding fan on under forced control to the highest permissible fan level for a defined period of 5 minutes. In this state incoming command value telegrams or a change-over of the mode of operation have no effect on the fan level. Only after this time has elapsed will the actuator react again to new command value specifications.

Fan protection is only executed, however, if it was enabled previously by an "ON" telegram via the communication object "Enable fan protection". If it is not enabled object value "OFF"), then the fan coil actuator suppresses the fan protection and does not execute fan protection, even after the fan has not moved for 24 hours! This feature can be used, for example, to suppress the fan protection in order to reduce noise in bedrooms, or when a "quiet room" is needed (auditorium or the like).

If the fan has not been moved for more than 24 hours and the fan protection cannot be executed due to it not being enabled, then the actuator saves the "need" for fan protection, and executes the protection later as soon as enabling is received via the object. If before the enabling is received the fan is activated again via command values or via other functions of the actuator, then the fan coil actuator resets the 24-hour time meter for the corresponding fan, and does not execute the fan protection later.

The object value of the communication object "Enable fan protection" is saved in the actuator only in volatile memory. This means that the object value and thus any fan protection enabling

previously granted are lost in the event of a device reset (bus and mains voltage failure or ETS programming). After a device reset the object value is set to "OFF" (not enabled).

During fan protection the fan coil actuator switches the fan to the highest permissible fan level. This maximum level can also be limited by the fan level limitation during fan protection as well.

- i** Special feature of restriction via the fan level limitation: With the setting "Fan level with limitation = switch off" the fan level limitation prevents execution of the fan protection. In this case the fan protection is tracked with the highest fan level as soon as the fan level limitation has been removed, if the fan protection is still enabled at that time and no new command value telegram has been received.

The 24-hour time meter of the fan protection is always stopped and reset in the event of an active disabling function, in the event of a fault (monitoring time of the cyclical monitoring elapsed), or in the event of manual control locally on the device. If the actuator is actively executing a fan protection function, i.e. the fan is switched on due to the protection function, then the actuator aborts the fan protection immediately if one of the above-mentioned events occurs. In this case at the beginning of manual control the switching states of the fan level outputs set by the fan protection are adopted in the manual control without change. A bus voltage failure alone does not reset the time meter of the fan protection. If the fan protection was last enabled via the communication object and the bus voltage fails, then the actuator continues to increment the time meter value as long as the mains voltage supply is switched on. If during the bus failure the maximum time value of 24 hours is reached, then when the bus voltage returns the actuator executes the fan protection, provided that the fan protection was last enabled before the bus failure. A failure only of the mains voltage also does not reset the time meter.

Fan protection is therefore only performed in normal operation (control via the bus by means of command value telegrams - no function with a higher priority activated) when bus and mains voltage is present.

After initialisation of the actuator (after bus and mains voltage return or after ETS programming), the 24-hour time meter is reset and restarted when fan protection is enabled. The first fan protection will thus be performed 24 hours after the initialisation at the earliest.

- i** If the actuator energizes a fan level outputs as part of the fan protection, then - if so enabled - the feedback "Fan coil active" is updated and if necessary sent to the bus.
- i** Valve protection and fan protection can also be executed at the same time. The heating and cooling valves are not affected by the fan protection alone, however.

Enabling fan protection

Fan protection can be enabled separately for each fan coil channel.

- Set the parameter "Fan protection" on the parameter page "Channel x - general" (x = number of the fan coil channel) to "when enabled cyclically 24h after last fan activation".
The communication object "Enable fan protection" in the ETS is enabled. The 24-hour meter is started automatically after initialisation of the actuator. If a fan is not activated for a period of 24 hours, then the actuator switches the corresponding fan to the the highest permissible fan level for a period of 5 minutes, so long as enabling was previously granted via the communication object. The fan protection is repeated cyclically every 24 hours, so long as in the meantime no fan activation is performed via command values, via a disabling function, or via manual control.

- Set the parameter "Fan protection" on the parameter page "Channel x - general" to "deactivated".

The fan protection is completely deactivated.

4.2.4.3.3 Basic configuration of the fan levels

Number of fan levels

The fan coil actuator can be adapted very flexibly to the specific fan coil application required by means of parameter configurations. Thus initially the number of fan levels required for the connected devices can be defined. The maximum number of usable fan levels is dependent on the number of fan coil channels configured in the ETS; with one fan coil channel it is possible to use 1 ... 6 fan levels, with two channels 1 ... 3 fan levels. With two fan coil channels the number of fan levels per channel can be specified independently.

Fan level outputs of a fan coil channel which are not used can optionally be used as switching outputs with a simple switching function.

The following table shows an overview of the output assignments for only one fan coil channel:

number of fan levels	output 3	output 4	output 5	output 6	output 7	output 8
6	level 1	level 2	level 3	level 4	level 5	level 6
5	level 1	level 2	level 3	level 4	level 5	switching A8
4	level 1	level 2	level 3	level 4	switching A7	switching A8
3	level 1	level 2	level 3	switching A6	switching A7	switching A8
2	level 1	level 2	switching A5	switching A6	switching A7	switching A8
1	level 1	switching A4	switching A5	switching A6	switching A7	switching A8

Figure 17: Overview of the output assignments for only one fan coil channel

number of fan levels	output 2	output 3	output 4	output 6	output 7	output 8
3	level 1	level 2	level 3	level 1	level 2	level 3
2	level 1	level 2	switching A4	level 1	level 2	switching A8
1	level 1	switching A3	switching A4	level 1	switching A7	switching A8

Figure 18: Overview of the output assignments for two fan coil channels

Using the unneeded fan level outputs as simple switching outputs

Fan outputs that are not used to control a fan level in the connected fan coil unit are designed as simple switching outputs. These switching outputs can be controlled independently by the bus via a 1-bit communication object, and have no settable parameters. The switching outputs can be used for simple switching tasks (e.g. switching of lighting or a status indication). As regards the contact rating, the technical data for the fan coil actuator must be observed!

As soon as the number of fan levels of a fan coil channel is limited in the ETS, the ETS automatically makes the communication objects of the switching outputs visible (see "Overview of output assignments" tables further above).

The behaviour of the switching outputs is implemented permanently in the device, and cannot be changed...

- Contact type: NO contact,
- Behaviour in case of bus voltage failure: no reaction,
- Behaviour in case of mains voltage failure: switch off;
- Behaviour in case of bus voltage return (mains voltage present): no reaction,
- Behaviour in case of mains voltage return (bus voltage present): same state as before mains failure,

- Behaviour in case of bus and mains voltage return: switch off,
- No time delay or the like.

i No separate feedback objects are present. The state of the communication objects is updated after bus voltage return, and can be read out (set "R"-flag!).

Setting the number of fan levels

The number of fan levels can be specified separately for each fan coil channel.

Before this the number of fan coil channels and the type of fan coil system must have been set on the parameter page "General".

- Set the parameter "Number of fan levels" on the parameter page "Cx - fan configuration" (x = number of the fan coil channel) to the required number of fan levels.

The required fan levels and the associated parameters are defined in the ETS.

i Unused fan level outputs are automatically defined as simple switching outputs.

Controlling the fan levels

In standard commercially available fan coil units, there is generally a distinction made between two different ways to control the fan levels...

- The change-over principle (only one level output can be switched on – all other levels must switch off),
- The level principle (the fan level outputs switch one after another (hierarchically) – lower levels remain switched on, higher levels switched off.).

Which of these two principles has to be used should be obtained from the technical documentation of the connected fan coil unit. The setting is then performed separately in the ETS for each fan coil channel.

The following tables illustrate the switching behaviour as a function of the specific active fan level and as a function of the principle that has been set.

The examples show the fan levels with the use of only one fan coil channel and the maximum number of fan levels (1...6). Control of the fan levels with two fan coil channels (2 x 1...3) is carried out in a similar manner.

active fan level	output 3	output 4	output 5	output 6	output 7	output 8
none (switched off)	off	off	off	off	off	off
level 1	ON	off	off	off	off	off
level 2	off	ON	off	off	off	off
level 3	off	off	ON	off	off	off
level 4	off	off	off	ON	off	off
level 5	off	off	off	off	ON	off
level 6	off	off	off	off	off	ON

Figure 19: Control of the fan levels with the change-over principle (only one output is switched on)

active fan level	output 3	output 4	output 5	output 6	output 7	output 8
none (switched off)	off	off	off	off	off	off
level 1	ON	off	off	off	off	off
level 2	ON	ON	off	off	off	off
level 3	ON	ON	ON	off	off	off
level 4	ON	ON	ON	ON	off	off
level 5	ON	ON	ON	ON	ON	off
level 6	ON	ON	ON	ON	ON	ON

Figure 20: Control of the fan levels with the level principle (fan outputs switch hierarchically one after the other)

The change-over principle:

When a fan is switched on, there is always only one fan level output active "ON". If the active fan level is changed, the fan coil actuator first switches the previously switched-on fan level off ("OFF" state), and only after that switches the other output on.

In this case the "Pause 'OFF' for level change-over" parameterised in the ETS is maintained (see "Defining behaviour of the fan levels"). This means that when the fan level is changed the fan coil actuator remains in the "OFF" state for the parameterised period, and switches directly to the specified level only after the time has elapsed.

Example:

Level 3 is active, then change-over to Level 6 via change in the command value -> first the fan level output 3 is switched off -> after that the actuator waits for the parameterised pause time -> only after that does it switch directly to Level 6.

When the fan is switched on, it is switched directly to the required fan level.

The level principle:

When a fan is switched on, several outputs are switched on, depending on the active fan level. When the fan level is increased, the adjacent output with the next higher output number is also switched on; the lower outputs remain switched on. When the active fan level is decreased, the switched-on output with the largest output number is switched off.

When the fan level is changed through more than one level, the change is not carried out abruptly, but rather always via interim brief activation of the intervening level(s). In this case the "Dwell time for level change-over" parameterised in the ETS is maintained (see "Defining behaviour of the fan levels"). This means that the fan coil actuator remains in each intervening level, and is only changed over to the next after the next following level after the time has elapsed.

Example:

Level 3 is active, then change-over to Level 6 via a change in the command value -> first switches to Level 4 and waits -> then switches to Level 5 and waits -> only after that switches to Level 6.

When the fan is switched on, the first level is also switched on initially, and only switched to Level 2 etc. after the end of the dwell time. When the fan level is changed by only one level, it is switched immediately to the adjacent fan level with no pause.

- i** The following applies for both principles: When the fan is switched on, the switch-on level and a switch-on delay for the fan are taken into account, if so parameterised in the ETS. Consequently a switch-off delay is carried out when the fan is switched off, if parameterised. Any activated fan level limitation is also taken into account.

Configuring the control of the fan levels

The control of the fan levels (level or change-over principle) is performed separately in the ETS for each fan coil channel.

Before this the number of fan coil channels and the type of fan coil system must have been set on the parameter page "General". Moreover, the number of fan levels must have been set already.

- Set the parameter "Control of the fan levels" on the parameter page "Cx - fan configuration" (x = number of the fan coil channel) to "only one fan output switches (change-over principle)".
As soon as the fan is running, there is always only one fan level output switched on. All other non-active levels are switched off.
 - Set the parameter "Control of the fan levels" on the parameter page "Cx - fan configuration" (x = number of the fan coil channel) to "Fan level outputs switch hierarchically (level principle)".
When the fan is switched on, the fan level outputs switch one after another (hierarchically). All fan levels lower than the active fan level remain switched on, higher ones switched off.
- i** When only one fan level is used, the parameter "Control of the fan levels" is always set to "only one fan output switches (change-over principle)".

Definition of the fan levels / active fan level

In normal operation the fan converts command values for heating and/or cooling received via the bus into the equivalent fan levels. Here the 1-byte command value telegrams have a decimal weight of 0...255. This decimal value range is represented in the percentage range 0% ... 100%.

Switch-on criterion:

The larger the active command value, the larger the active fan level to be set by the actuator. So that the fan coil actuator can evaluate which of the up to 6 fan levels of a fan coil channel has to be set to active, each fan level has a lower limit for the command value assigned to it. Assignment is carried out in the ETS by parameterising a command value (1...100 %) for each fan level.

As soon as a command value reaches or crosses a lower limit, the actuator activates the corresponding fan level.

Example (3 fan levels):

Lower limit for fan level 1: 10%,

Lower limit for fan level 2: 30%,

Lower limit for fan level 3: 70%.

Reaction:

Active command value 25% -> fan level 1 is active.

Now the active command value changes to 35 %. -> fan level 2 is active.

Now the active command value changes to 80 %. -> fan level 3 is active.

- i** The change-over of the fan levels is always performed taking into account the fan level control set in the ETS (change-over principle or level principle), and taking into account the dwell time or pause time.

As long as the fan is switched off, command values below the lower limit for fan level 1 cause the fan to remain switched off. For the command value "0 %" the fan remains switched off in any case.

Example (3 fan levels):

Lower limit for fan level 1: 10%,

Lower limit for fan level 2: 30%,

Lower limit for fan level 3: 70%.

Reaction:

Active command value is 0% -> fan is switched off.

Now the active command value changes to 5 %. -> fan remains switched off.

Now the active command value changes to 15 %. -> fan level 1 is active.

Now the active command value changes to 35 %. -> fan level 2 is active.

Switch-off criterion / hysteresis:

In addition to considering the parameterised lower limits for activating a fan level, the actuator also takes into account a hysteresis for deactivating fan levels. A fan level is only deactivated when the active command value reaches or undershoots the lower limit of the level less the hysteresis derived from the lower limit. The purpose of this behaviour is to prevent constant change-over of the fan levels when the command value is located at the limit between two fan levels.

In addition, when a fan is switched on, command values below the lower limit for fan level 1 minus the hysteresis cause the fan to be switched off. With the command value "0 %" the fan switches off in any case. Please note that when a switch-off delay is enabled in cooling operation switching-off may be performed with a time delay.

- i** The hysteresis is only taken into account for deactivation of fan levels, i.e. for switching the fan to a lower level.

The hysteresis is parameterised in the ETS in common for all fan levels of a fan coil channel as a percentage value (0...20 %). The absolute command value that has to be reached or undershot for deactivation of a fan level is derived relatively from each command value lower limit, taking into account the common hysteresis.

Example:

Hysteresis: 5 %

Lower limit for fan level 1: 10%,

Lower limit for fan level 2: 30%,

Lower limit for fan level 3: 70%.

Calculation:

Command value for deactivation of the fan level = lower limit of level - (lower limit of level * hysteresis)

-> Command value for deactivation of fan level 1 = 10 % - (10 % * 5 %)

-> Command value for deactivation of fan level 1 = 0.1 - (0.1 * 0.05) = 0.1 - (0.005)

-> 0.005 is rounded up to 0.01 (full percentage point - corresponds here to 1 %)

-> Command value for deactivation of fan level 1 = 0.1 - (0.01) = 10 % - 1 % = 9 %

...

-> Command value for deactivation of fan level 2 = 28 %

-> Command value for deactivation of fan level 3 = 66 %

Reaction:

Active command value 15% -> fan level 1 is active.

Now the active command value changes to 5 %. -> fan switches off.

Now the active command value changes to 35 %. -> fan level 2 is active.

Now the active command value changes to 29 %. -> Fan level 2 remains active, because the hysteresis command value for level 2 (28 %) was not undershot.

Now the active command value changes to 25 %. -> fan level 1 is active.

- i** With the hysteresis setting "0 %" the hysteresis is inactive, meaning that a fan level is deactivated immediately when its command value lower limit is undershot.

The following command value diagram (figure 21) illustrates the evaluation of the lower limits for the fan levels and how the hysteresis is taken into account for a fan level change-over. The diagram is simplified, and does not take into account any dwell time or pause time for level change-over (only the active fan level is illustrated), nor any optional switch-on level or additional switch-on or switch-off delays.

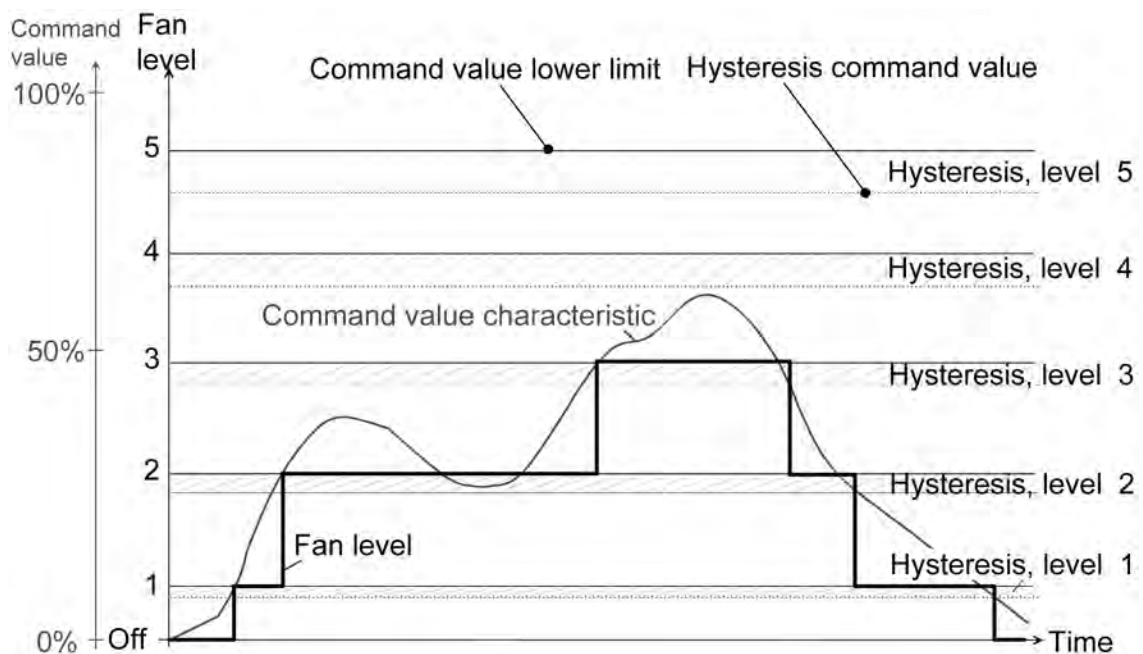

Figure 21: Simplified command value diagram to illustrate a fan level change-over (active fan level), taking into account the command value lower limits and the hysteresis

Setting lower limits for command values

So that the fan coil actuator can evaluate which of the up to 6 fan levels of a fan coil channel has to be set to active, each fan level has a lower limit for the command value assigned to it. Assignment is carried out in the ETS by parameterising a command value (1...100 %) for each fan level.

As soon as a command value reaches or crosses a lower limit, the actuator activates the corresponding fan level.

Before this the number of fan coil channels and the type of fan coil system must have been set on the parameter page "General". Moreover, the number of fan levels must have been set already.

- Set the parameter "Command value lower limit for fan level ... (1...100 %)" on the parameter page "Cx - fan configuration" (x = number of the fan coil channel) to the necessary command value. This setting must be made for each fan level.

A fan level switches on when its command value lower limit is reached or exceeded. This fan level switches off again as soon as its command value lower limit minus the hysteresis is undershot again.

- i** The following applies: lower limit for level 1 < lower limit for level 2 < ... < lower limit for level 6.

The lower levels for the various fan levels set in the ETS may not be set to identical values, and also may not overlap! Otherwise the fan levels can no longer be controlled unambiguously according to their sequence!

The ETS does not catch such parameterisation errors automatically!

- i** The number of the parameter "Command value lower limit for fan level ... (1...100 %)" depends on the parameterised number of fan levels.

Setting the hysteresis

A fan level is only deactivated when the active command value reaches or undershoots the lower limit of the level less the hysteresis derived from the lower limit. The hysteresis is set in the ETS only once per fan coil channel, and is derived relatively from each command value lower limit.

Before this the number of fan coil channels and the type of fan coil system must have been set on the parameter page "General". Moreover, the number of fan levels must have been set already.

- Set the parameter "Hysteresis for level change-over (0...20 %)" on the parameter page "Cx - fan configuration" (x = number of the fan coil channel) to the necessary hysteresis.

The set hysteresis affects all of the fan levels relatively. The absolute hysteresis command value is derived individually for each level from its command value lower limit. As soon as the hysteresis command value for a level is undershot, the fan coil actuator deactivates this level.x

- i** With the setting "0 %" the hysteresis is inactive, meaning that a fan level is deactivated immediately when its command value lower limit is undershot.

4.2.4.3.4 Defining the behaviour of the fan levels

After the fan levels have been configured, i.e. the appropriate number and the type of control have been set and the command value lower limits incl. the hysteresis have been configured, the fan level behaviour of a fan coil channel can be configured in the ETS

It is generally recommended to retain this sequence for the ETS parameterisation, because the parameters that defined the behaviour of the fan (parameter page "Cx - behaviour") are dependent on the configuration parameters (parameter page "Cx - configuration").

The fan behaviour generally determines the reaction when the fan is switched on and off and when there is a level change-over. In addition it is possible to configure a level limitation here.

Fan level when the fan is switched on (switch-on level)

When the fan is switched on, i.e. if it was switched off before and was at a standstill, the fan can be switched on temporarily to a defined switch-on level. This switch-on level can be any of the available fan levels, and is set in the ETS.

The switch-on level is generally one of the higher fan levels, so that at the beginning of a heating or cooling process the fan in the fan coil unit can start up optimally (reliable start-up of the fan motor through transfer of a higher torque, and thus a higher fan speed).

The switch-on level has the highest priority in the fan coil actuator, because it relates to a mechanical characteristic of the connected fan. The switch-on level is thus set and executed every time the fan is switched on regardless of whether the fan was switched on via a command value specification (normal operation), via manual fan activation, via the command value monitoring, via the disabling function, or via manual control. Even when the mode of operation is changed (heating <-> cooling), the switch-on level is always executed when the fan is switched on again.

How long the fan runs after it is switched on in the switch-on level can be configured in the ETS as a dwell time. The fan thus remains in the switch-on level until the set dwell time has elapsed. Changes in the active fan level, for example via a new command value specification during the dwell time (exception: command value = "0"), do not cause a change-over of the fan level. Only after the end of the dwell time does it switch to the fan level corresponding either to the last command value specification or to the direct fan level specification (disabling function, cyclical monitoring, manual fan control, etc.).

The dwell time cannot be retriggered. If in normal operation the switch-on time of the fan is to be switched off via a new command value specification (command value = "0") during the dwell time, then the dwell time is terminated immediately and the fan is also switched off immediately.

The following command value diagram (figure 22) illustrates the fan behaviour after switching on, taking a switch-on level into account. The diagram is simplified, and does not take into account any dwell time or pause time for level change-over (only the active fan level is illustrated), nor any additional switch-on or switch-off delays.

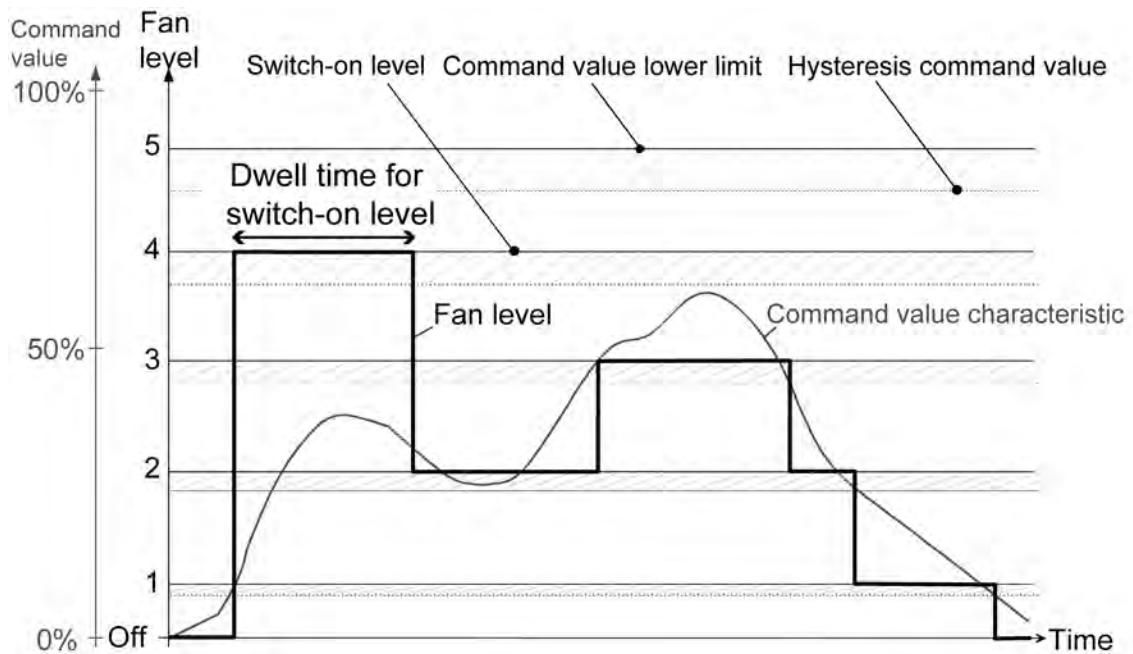

Figure 22: Simplified command value diagram to illustrate a fan level change-over (active fan level), taking into account the switch-on level

When the fan is switched on to the switch-on level, the "Control of the fan levels" (change-over principle / level principle) parameterised in the ETS is also taken into account. The following examples are intended to illustrate the behaviour of the fan coil actuator in this respect. The following table shows the configuration used for the outputs (1 fan coil channel / 6 fan levels / 2-pipe heating). Other configurations behave in a similar manner.

A1	A2	A3	A4	A5	A6	A7	A8
Heating	Not used	Level 1	Level 2	Level 3	Level 4	Level 5	Level 6

Output configuration used in the examples for the switch-on level

When the fan levels are controlled with the change-over principle (only one output switches on), the output is switched on immediately in accordance with the switch-on level. After the end of the dwell time the fan output is set in accordance with the active fan level.

Example:

The fan is switched off.

Parameterised switch-on level = 5 / control of the fan levels = change-over principle.

The fan is switched on by new command value specification / active fan levels according to command value = 3.

-> The fan initially switches to the switch-on level (level 5, only output 7 closes) and remains at this level for the "Dwell time for switch-on level" set in the ETS.

-> After the end of the dwell time the fan is initially switched off for the "Duration of the pause 'OFF' for level change-over" (outputs 3-8 OFF).

-> after the end of the pause time the fan is switched to the active fan level (level 3, only output 5 closes).

When the fan levels are controlled with the level principle (fan outputs switch hierarchically), in the case of level change-over initially all of the "lower" levels are switched on, taking the dwell time into account.

Example:

The fan is switched off.

Parameterised switch-on level = 5 / control of the fan levels = level principle.

The fan is switched on by new command value specification / active fan levels according to command value = 3.

-> The fan initially switches the first fan level on (only output 3 closes) and remains at this level for the time of the "Dwell time for level change-over".

-> After that all of the additional levels (outputs 3-6) are switched on in the same manner in stages as far as the switch-on level. The fan then remains at the switch-on level (level 5, outputs 3-7 close) for the "Dwell time for switch-on level" set in the ETS.

-> After the end of the dwell time for the switch-on level the fan is switched back to the active fan level in stages, maintaining the "Dwell time for level change-over" (level 3, outputs 3-5 close).

Example:

The fan is switched off.

Parameterised switch-on level = 2 / control of the fan levels = level principle.

The fan is switched on by new command value specification / active fan levels according to command value = 4.

-> The fan initially switches the first fan level on (only output 3 closes) and remains at this level for the time of the "Dwell time for level change-over".

-> After that it switches to the switch-on level (level 2, outputs 3-4 close). The fan then remains there for the "Dwell time for switch-on level" set in the ETS.

-> After the end of the dwell time for the switch-on level the fan is initially switched, maintaining the "Dwell time for level change-over", back to level 3 (outputs 3-5 close), and then to the active fan level (level 4, outputs 3-6 close).

The "Dwell time for switch-on level" thus has a higher priority than the "Dwell time for level change-over".

- i** The following applies for both principles: If the switch-on level corresponds directly to the last active fan level specified, then the actuator remains in the set fan level after the end of the dwell time.

Configuring the switch-on level

The switch-on level and the dwell time for the switch-on level are set in the ETS separately for each fan coil channel.

Before configuration of the switch-on level in the ETS, the number of fan coil channels and the type of fan coil system must have been set on the parameter page "General". Moreover, the number of fan levels must have been set already on the parameter page "Cx - fan configuration".

- Set the parameter "Fan level when the fan is switched on" on the parameter page "Cx - fan behaviour" (x = number of the fan coil channel) to "as specified by command value lower limits".

The switch-on level is deactivated. The fan switches on to the active fan level. In normal operation the active fan level is determined based on the command value telegrams received and the specified level weight (command value lower limits).

- Set the parameter "Fan level when the fan is switched on" on the parameter page "Cx - fan behaviour" to "independent switch-on level (time-controlled)".
For the parameter "Switch on to switch-on level", configure the level to which the fan is to be switched on (1...max. 6 - the selection is limited by the number of fan levels available). Also set the "Dwell time for switch-on level" (1...59 s).

The switch-on level is activated. The fan switches on to the switch-on level and remains in this level until the dwell time has elapsed. Only after that does it switch to the specified active fan level.

- i** When the fan is switched on to the switch-on level and change-over to the active fan level after the end of the dwell time, the control of the fan levels according to the change-over principle or the level principle is always taken into account.
- i** The dwell time of the switch-on level cannot be retrIGGERED. If in normal operation the switch-on time of the fan is to be switched off via a new command value specification (command value = "0") during the dwell time, then the dwell time is terminated immediately and the fan is also switched off immediately.
In addition the "Dwell time for switch-on level" has the highest priority in the actuator and overrides the "Dwell time for level change-over".

Switch-on delay for the fan in the mode of operation "Heating"

In order to prevent cold air from flowing out at the beginning of a heating process, a switch-on delay can be configured in the ETS for the fan. Delaying the switching-on of the fan means that air is not blown into the room immediately. Instead, first only the heating valve is opened, thus heating up the heat exchanger of the fan coil unit. Only after that does the fan switch on and blow pre-heated air into the room.

The fan ON delay is only taken into account when the fan is switched on together with the heating valve from the "OFF" state to one of the levels.

In fan coil systems with a combined heating / cooling mode of operation, when there is a change-over of the mode of operation the fan is initially switched off, and likewise switched on again only after the configured switch-on delay.

If during the switch-off delay the fan coil actuator receives the command value "0" (switch off), or if this value is specified as the active fan level, then the switch-on delay is aborted and the fan level outputs remain switched off. The switch-on delay is furthermore not retrIGGERED if additional command values not equal to "0" are received.

- i** If the fan is switched on without the heating valve, for example in case of manual fan control, then the switch-on delay is not executed. The switch-on delay is also not taken into account in case of manual control directly on the device and in case of bus voltage failure or bus/mains voltage return.
In these cases the fan can be activated with no delay.
- i** The switch-on delay is only taken into account for switching on the fan in the mode of operation "Heating". For cooling the fan can be switched on without delay.

The following command value diagram (figure 23) illustrates the fan behaviour after switching on in the mode of operation "Heating", taking a switch-on delay into account. The diagram is simplified, and does not take into account any dwell time or pause time for level change-over (only the active fan level is illustrated), nor any switch-on level which may be parameterised. A switch-on level would take place after the end of the switch-on delay.

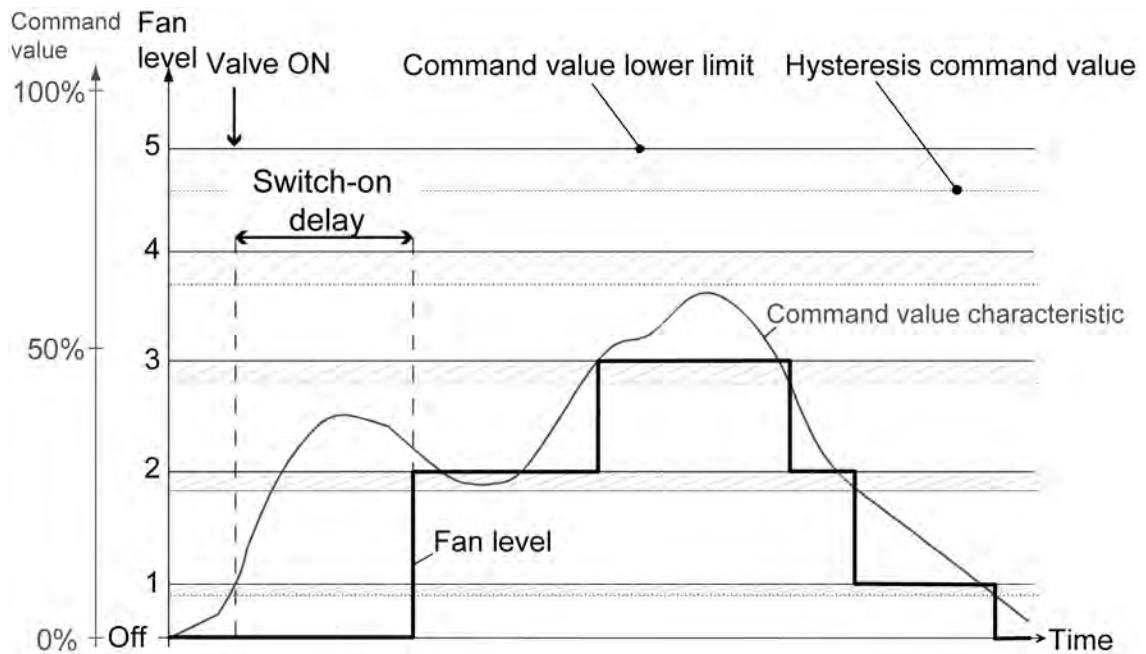

Figure 23: Simplified command value diagram to illustrate a fan level change-over (active fan level), taking into account a switch-on delay

Configuring the switch-on delay

The switch-on delay is configured in the ETS separately for each fan coil channel.

Before configuration of the switch-on delay in the ETS, the number of fan coil channels and the type of fan coil system must have been set on the parameter page "General".

- Set the parameter "Fan switch-on delay for heating" on the parameter page "Cx - fan behaviour" (x = number of the fan coil channel) to the required delay time. The setting "0 minutes 0 seconds" deactivates the delay completely.

When the fan is switched on in heating operation the delay time is started and processed. The fan switches on (if necessary to the switch-on level) only after the delay time has elapsed.

- i** The switch-on delay can only be configured for fan coil systems with the mode of operation "Heating" or "Heating / Cooling". Otherwise the associated parameters are not visible.
- i** The switch-on delay for the fan is only executed if the fan is switched on together with the heating valve from the "OFF" state to one of the levels. The switch-on delay has no effect in cooling operation or for manual fan control.
- i** If during the switch-off delay the fan coil actuator receives the command value "0" (switch off), or if this value is specified, then the switch-on delay is aborted and the fan level outputs remain switched off. The switch-on delay is furthermore not retriggered if additional command values not equal to "0" are received.
- i** The delay has no effect on the switching behaviour of the valves.

Switch-off delay for the fan in the mode of operation "Cooling"

In order to prevent freezing of the cooling register at the end of a cooling process, a switch-off delay can be configured in the ETS for the fan. The delayed switch-off of the fan means that the air flow through the cooling register of the fan coil unit is not stopped immediately. Instead, first only the cooling valve is closed, thus continuing to blow air "through" the heat exchanger of the fan coil unit. The fan does not switch off until after the end of the delay.

The fan OFF delay is only taken into account if the fan is switched off, for example via the command value specification "0", when the cooling valve is switched on.

In fan coil systems with a combined heating / cooling mode of operation, when there is a change-over of the mode of operation the fan is initially switched off only after the configured switch-off delay, and then switched on again.

If the fan coil actuator again receives a command value for cooling that is not equal to "0", or if such a value is specified as the active fan level, then the switch-off delay is aborted and the fan level remains switched on. Moreover, the switch-off delay is not retriggered if additional command values equal to "0" are received.

- i** If the fan is switched off without the cooling valve being switched on, for example in case of manual fan control, then the switch-off delay is not executed. The switch-off delay is also not taken into account in case of manual control directly on the device and in case of bus voltage failure or bus/mains voltage return. In these cases the fan can be activated with no delay.
- i** The switch-off delay is only taken into account for switching off the fan in the mode of operation "Cooling". For heating the fan can be switched off without delay.

The following command value diagram (figure 24) illustrates the fan behaviour after switching off in the mode of operation "Cooling", taking a switch-off delay into account. The diagram is simplified, and does not take into account any dwell time or pause time for level change-over (only the active fan level is illustrated).

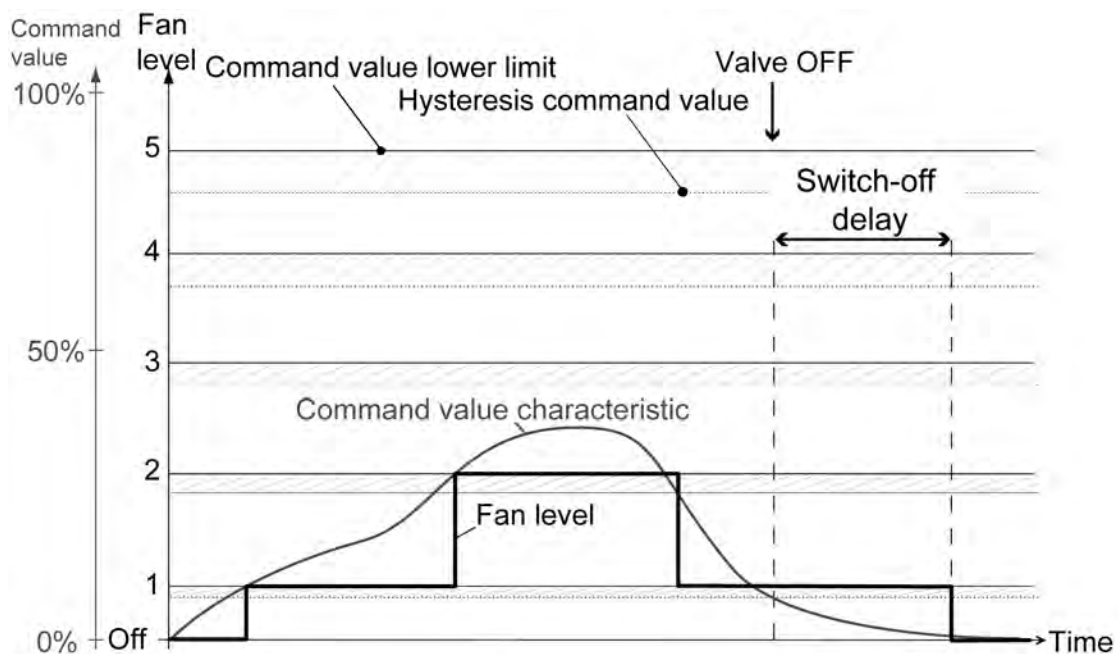

Figure 24: Simplified command value diagram to illustrate a fan level change-over (active fan level), taking into account a switch-off delay

Configuring the switch-off delay

The switch-off delay is configured in the ETS separately for each fan coil channel.

Before configuration of the switch-off delay in the ETS, the number of fan coil channels and the type of fan coil system must have been set on the parameter page "General".

- Set the parameter "Fan switch-off delay for cooling" on the parameter page "Cx - fan behaviour" (x = number of the fan coil channel) to the required delay time. The setting "0 minutes 0 seconds" deactivates the delay completely.

When the fan is switched off in cooling operation the delay time is started and processed. The fan switches off only after the delay time has elapsed.

- i** The switch-off delay can only be configured for fan coil systems with the mode of operation "Cooling" or "Heating / Cooling". Otherwise the associated parameters are not visible.
- i** The switch-off delay for the fan is only executed if the fan is switched off, for example via the command value specification "0", when the cooling valve is switched on. The switch-off delay has no effect in heating operation or for manual fan control.
- i** If the fan coil actuator again receives a command value for cooling that is not equal to "0", or if such a value is specified, then the switch-off delay is aborted and the fan level remains switched on. Moreover, the switch-off delay is not retriggered if additional command values equal to "0" are received.
- i** The delay has no effect on the switching behaviour of the valves.

Dwell time for level change-over / pause "OFF" for level change-over

Due to fan motors' inertia, as a rule there is a limit to how short the time intervals for switching the fan levels can be, i.e. there is a limit to how quickly the fan speed can be varied. Often the technical information for a fan coil unit specifies change-over times that the fan coil actuator must maintain for each fan level change-over. The change-over direction, i.e. whether the level is being increased or decreased, does not play any role here.

When the fan level is changed-over, the "Control of the fan levels" (change-over principle / level principle) parameterised in the ETS is taken into account and distinguished.

Behaviour with the change-over principle (only one output switches):

When a fan is switched on, there is always only one fan level output active "ON". If the active fan level is changed, the fan coil actuator first switches the previously switched-on fan level off ("OFF" state), and only after that switches the other output on.

In this case the "Pause 'OFF' for level change-over" parameterised in the ETS is maintained. This means that when the fan level is changed the fan coil actuator remains in the "OFF" state for the parameterised period, and switches directly to the specified level only after the time has elapsed. If during the pause "OFF" new command values are received or specified, then after the end of the pause time the fan coil actuator switches to the fan level in accordance with the new specification.

If the fan was switched off and is switched on to any of the levels, then the fan coil actuator switches the corresponding fan output on immediately with no pause (if necessary taking into account a switch-on delay in heating operation). Similarly, the fan switches off immediately with no pause in case of a "0" command value or a switch-off command (e.g. disabling function) (taking any switch-off delay in cooling operation into account if necessary).

The following command value diagram (figure 25) illustrates by means of an example the pause "OFF" for a fan level change-over with the change-over principle. The diagram is simplified, and does not take into account any optional switch-on level or additional switch-on or switch-off delays. Moreover, the the pause time is shown with an "exaggerated" length in order to convey the switching behaviour better.

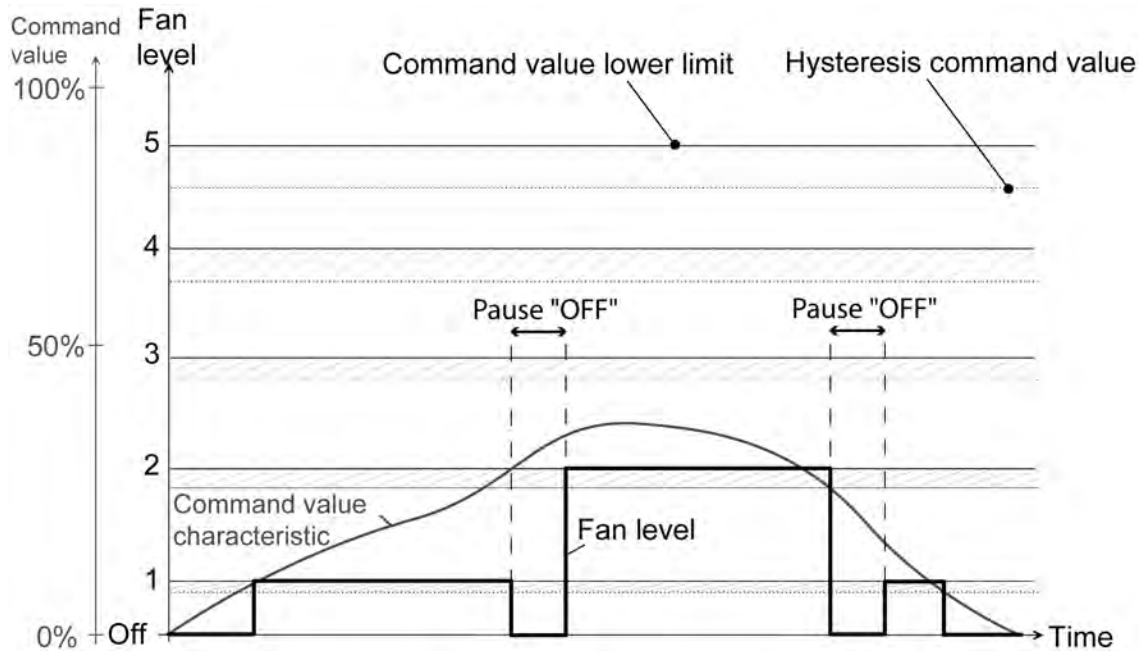

Figure 25: Simplified command value diagram to illustrate a fan level change-over with the change-over principle, taking into account the pause "OFF" 1

Behaviour with the level principle (fan outputs switch hierarchically):

When a fan is switched on, several outputs are switched on, depending on the active fan level. When the fan level is increased, the adjacent output with the next higher output number is also switched on; the lower outputs remain switched on. When the active fan level is decreased, the switched-on output with the largest output number is switched off.

When the fan level is changed through more than one level, the change is not carried out abruptly, but rather always via brief activation of the intervening level(s).

In this case the "Dwell time for level change-over" parameterised in the ETS is maintained. This means that the fan coil actuator remains in each intervening level, and is only changed over to the next after the next following level after the time has elapsed.

When the fan is switched on, the first level is also switched on initially (taking any switch-on delay in heating operation into account if necessary), and only switched to Level 2 etc. after the end of the dwell time. When the active fan level is changed by only one level, it is switched immediately to the adjacent fan level with no pause.

The following command value diagram (figure 26) illustrates by means of an example the dwell time for a fan level change-over with the level principle. The diagram is simplified, and does not take into account any optional switch-on level or additional switch-on or switch-off delays. Moreover, the length of the dwell time is merely an example.

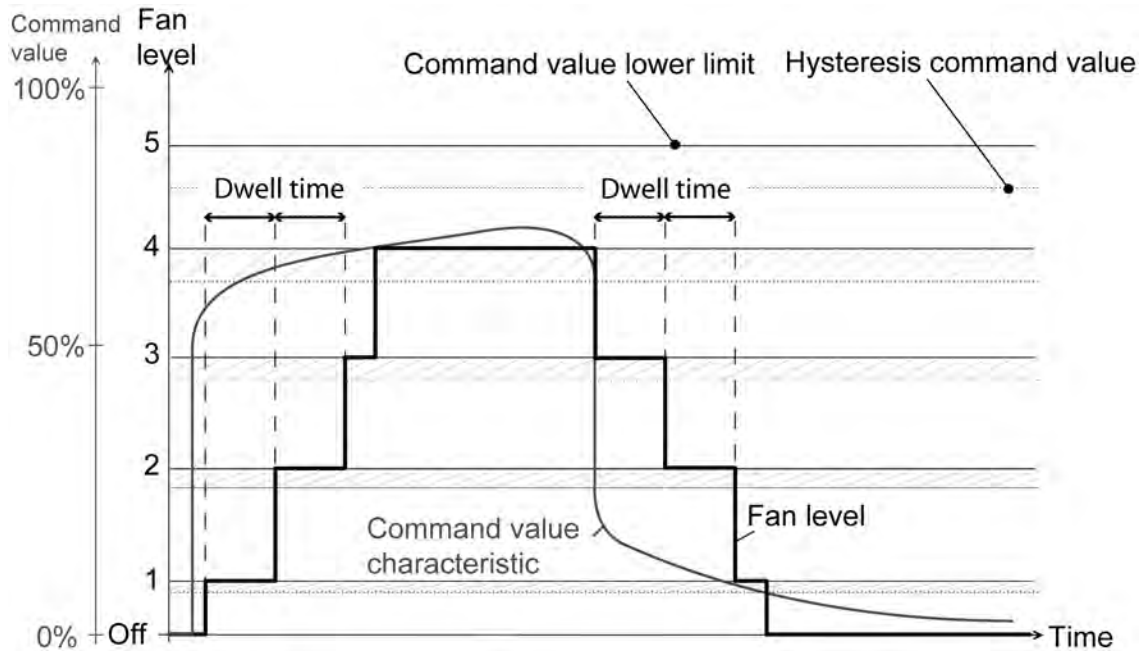

Figure 26: Simplified command value diagram to illustrate a fan level change-over with the level principle, taking into account the dwell time

- i** Because the "Dwell time for level change-over" and the "Pause 'OFF' for level change-over" are derived from a specified characteristic of the connected fan coil unit, these times are always taken into account in all modes of operation of the fan coil actuator (e.g. manual control, disabling function, etc.).

An exception to this, however, is manual control of the fan in control with the level principle! In this case the dwell time for the level change-over is not maintained in case of a manual change-over of the fan levels, in order to be able to operated the levels with no delay and with an immediate (visual) reaction of the fan.

- i** The "Dwell time for switch-on level" (when a switch-on level is used) always has the highest priority in the fan coil actuator.
With the level principle: The "Dwell time for level change-over" can be overridden by a "Dwell time for switch-on level" (see "Fan level when the fan is switched on (switch-on level)").

With the change-over principle: The "Dwell time for switch-on level" does not affect the "Pause 'OFF' for level change-over". Both times are taken into account when the fan is switched on and in case of a subsequent level change-over.

Set pause "OFF" for level change-over

The pause "OFF" is set separately in the ETS for each fan coil channel. The pause is only visible and effective for channels with fan level change-over with the change-over principle.

Before configuration of the pause time in the ETS, the number of fan coil channels and the type of fan coil system must have been set on the parameter page "General". The "control of the fan levels" must be set to the "change-over principle".

- Set the parameter "Pause 'OFF' for level change-over" on the parameter page "Cx - fan behaviour" (x = number of the fan coil channel) to the required pause time (100 milliseconds ... 2 seconds 900 milliseconds).

When the fan level is changed-over, the last fan level output switched on is switched off. Only after the end of the pause time does the fan coil actuator switch the "new" fan output on.

- i** If the fan was switched off and is switched on to any of the levels, then the fan coil actuator switches the corresponding fan output on immediately with no pause (if necessary taking into account any switch-on delay in heating operation). Similarly, the fan switches off immediately with no pause in case of a "0" command value or a switch-off command (e.g. disabling function) (if necessary taking into account a switch-off delay in cooling operation).
- i** The pause time for change-over of the fan level cannot be deactivated!

Setting the dwell time for level change-over

The dwell time is set separately in the ETS for each fan coil channel. The dwell time is only visible and effective for channels with fan level change-over with the level principle.

Before configuration of the dwell time in the ETS, the number of fan coil channels and the type of fan coil system must have been set on the parameter page "General". The "control of the fan levels" must be set to the "level principle".

- Set the parameter "Dwell time for level change-over" on the parameter page "Cx - fan behaviour" (x = number of the fan coil channel) to the dwell time (100 milliseconds ... 2 seconds 900 milliseconds).

When the fan level is changed through more than one level, the change is carried out taking the dwell time into account via brief activation of the intervening level(s).

- i** When the fan is switched on, the first level is also switched on initially (taking any switch-on delay into account if necessary), and only switched to Level 2 etc. after the end of the dwell time. When the active fan level is changed by only one level, it is switched immediately to the adjacent fan level with no pause.
- i** The dwell time for change-over of the fan level cannot be deactivated!
- i** In case of manual control of the fan, the dwell time has no effect for a level change-over, i.e. the fan outputs can be switched up and down with no delay.

Level limitation

To reduce the fan noise of a fan coil unit, the fan level limitation can be activated. The level limitation reduces the sound emissions by limiting the maximum fan level to a fan level value specified in the ETS (limitation level). The limitation can be switched on and off via a 1-bit communication object via the bus, and thus activated in accordance with requirements, for example via a timer during nighttime hours in order to reduce noise in bedrooms, or via "manual" operation of a push-button when a "quiet room" is needed (auditorium or the like).

The limitation of the fan level is activated by receipt of a "1" telegram via the object "Level limitation". Deactivation is therefore accomplished through the receipt of a "0" telegram. While a limitation is active, the fan coil actuator prevents the fan from being switched to a higher level than the limitation level. If at the instant that the limitation is activated the fan is running at a level that is greater than the limitation level, then the fan level is immediately reduced to the limitation value. In this case the dwell time or the pause "OFF" is also taken into account in the level change-over. When the fan is switched on, however, reduction to the limitation value is only performed after any switch-on level that may be active has been processed.

The limitation level can be one of the available lower fan levels; the largest fan level cannot be selected. Moreover, in case of a limitation the fan can also be switched off completely (taking any switch-off delay into account if necessary). In this case the valves are also closed under forced control, if they were open at the instant of the limitation.

The level limitation has an effect on the following functions...

- Fan level control via the bus by means of regular command value telegrams,
- Manual fan control,

- Fan level after the end of the monitoring time for cyclical monitoring.
- Fan protection.

A fan level limitation has no effect on...

- a disabling function,
- manual control directly on the actuator,
- a switch-on level,

i After deactivation of one of these functions with higher priority, a level limitation is taken into account if the limitation is activated at that instant.

After an effective level limitation has been deactivated via the object, the fan coil actuator sets the non-limited setpoint fan level for the channel concerned, thus increasing the fan level directly if necessary. In this case, if the fan was switched off and switched on again via the level limitation, a switch-on level is also executed, provided that it is parameterised.

i The value of the object "Level limitation" is saved in non-volatile memory in the event of bus or mains voltage failure (depending on which of these voltages fails first). Any level limitation active before the bus or mains voltage failure is resumed after bus or mains voltage return, if the parameter "Behaviour after bus or mains voltage return" is set to "Valve & fan states as before bus/mains voltage failure". Otherwise the level limitation is inactive.

The following command value diagram (figure 27) illustrates by means of an example the reaction to a level limitation for an active fan level that is above the limitation level. The diagram is simplified, and does not take into account any dwell times or pause times for the fan level change-over, nor any optional switch-on level or additional switch-on or switch-off delays.

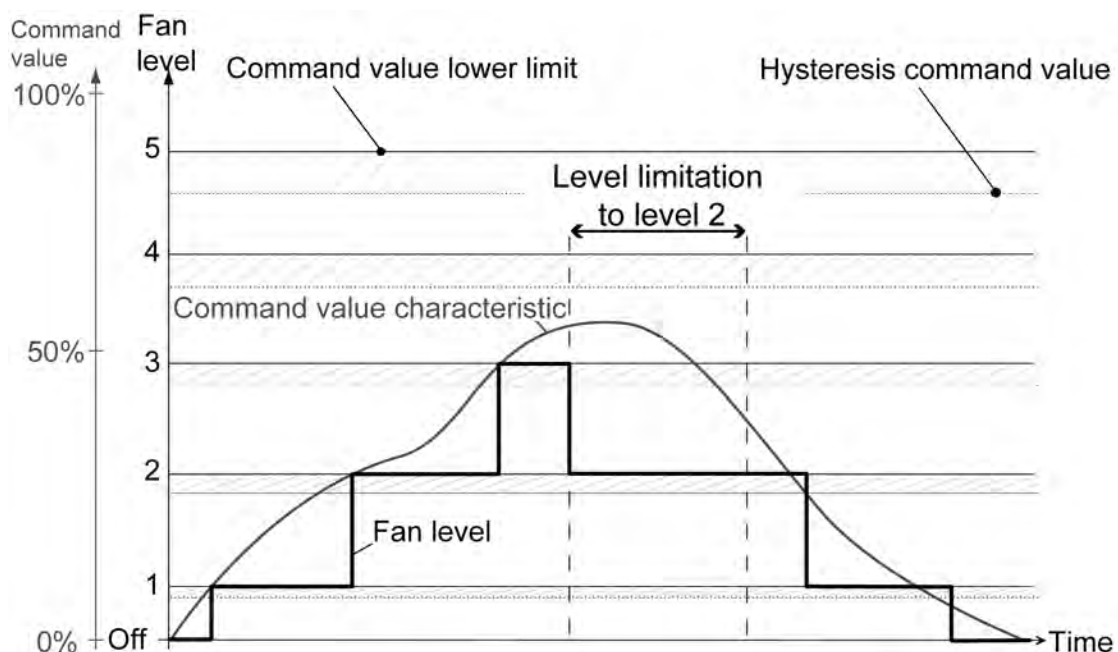

Figure 27: Simplified command value diagram to illustrate the reaction to a fan level limitation

Configuring the level limitation

To reduce the fan noise of a fan coil unit, the fan level limitation can be activated. The limitation is switched on and off via a 1-bit communication object via the bus, and thus activated in accordance with requirements. In order for it to be used, the level limitation must be enabled in the ETS for each fan coil channel.

Before configuration of the level limitation in the ETS, the number of fan coil channels and the type of fan coil system must have been set on the parameter page "General". Moreover, the number of fan levels must have been set already on the parameter page "Cx - fan configuration".

- Set the parameter "Level limitation via object" on the parameter page "Cx - fan behaviour" (x = number of the fan coil channel) to "enabled". After that, configure the limitation level in the parameter "Fan level with limitation" (Switch off fan ... max. level 5 - the selection is limited by the available number of fan levels).

The communication object becomes visible in the ETS. As soon as the level limitation is activated via the object, the fan coil actuator limits the fan level and thus the fan speed and consequently the fan noise for fan level control via the bus by means of regular command value telegrams, for manual fan control, for fan level specification of the cyclical monitoring, and for fan protection.

In case of the setting "Switch off fan" for the level limitation, the fan and also any valves that are switched on are switched off as soon as the limitation is activated.

4.2.4.3.5 Feedback telegrams

Feedback for the active fan level

The fan coil actuator can send feedback for the specific fan level that is active to the bus separately for each channel. In this manner the state of the fan coil unit can be transmitted to the bus at any time and displayed in a visualisation or evaluated further in other bus devices, for example.

The feedback for the active fan level takes place depending on the data format set in the ETS either via individual 1-bit communication objects separately for each fan level or alternatively via only one 1-byte value object in common for all fan levels of a channel.

With fan level feedback via value the feedback object returns the currently valid fan level as a numeric value (acc. to KNX DPT 5.010). The numeric value corresponds directly to the active fan level (0...max. 6; 0 = no level output switched on, fan OFF). This numeric value is thus limited by the maximum number of fan levels configured in the ETS for the fan coil channel concerned.

As an alternative to this data format it is possible to use fan level feedback via separate 1-bit communication objects. Here the feedback returns switching states directly that identify with regard to a fan level whether the corresponding fan output (acc. to KNX DTP 1.001) is switched on or off. Thus there exist (1...max. 6) separate objects for each fan level. Therefore all objects have the state "OFF" when the fan is stopped, i.e. when it is switched off.

Which data format is used depends on the type of evaluation for the fan feedback telegram in other bus devices (e.g. visualisation), and is thus configured in accordance with requirements. For feedback via 1-bit communication objects it should be noted that when the fan level is changed from one active level to another two telegrams are always transmitted to the bus, if the objects are configured as actively transmitting. For this reason, in level change-over with the level principle a higher bus load may occur for a short time, if the fan is switched through several levels with a short dwell time. This effect becomes more pronounced if several fan coil actuators are changed-over at the same time, so that each of them sends its own feedback telegrams to the bus. This is only one reason that fan level feedback via the value of the 1-bit feedback should be preferred.

In all modes of operation of the actuator, i.e. also for manual control on the device, the fan level feedback always returns the current fan state to the bus, as long as the bus voltage is connected and switched on.

The feedback also takes into account disabling states, switch-on or switch-off delays for the fan, and in case of a level change-over also switching processes over intermediate levels (with the level principle) or pause state (in the change-over principle). Exception: With fan level feedback via a value telegram any pause state for a fan level change-over with the change-over principle is not returned in order to prevent two value telegrams from being transmitted to the bus instantaneously.

Regardless of the data format of the fan level feedback, a distinction is made between feedback objects that function as actively transmitting signalling objects or as passive status objects. When functioning as an active signalling object, every time the feedback is updated by the fan coil actuator (change in the fan level), a telegram is also sent immediately to the bus. When functioning as a passive active status object, no telegram is transmitted to the bus when the feedback is updated. Rather, only the object value is updated, which can then be read out via the bus, for example using a visualisation. The configuration as a signalling or status object is performed in the ETS, which then automatically sets the necessary communication flags for the feedback objects.

i It is entirely possible, even when a signalling object is active, to set the "Read" flag in the ETS subsequently, in order to keep the read-out functionality of the object.

Enabling and configuring feedback for the active fan level

Feedback for the active fan level can take place separately for each fan coil channel, and for this reason is also enabled and configured separately in the ETS.

Before configuration of the fan level feedback, the number of fan coil channels and the type of fan coil system must have been set in the ETS on the parameter page "General".

- Set the parameter "Feedback for the active fan level" on the parameter page "Cx - fan feedback" (x = number of the fan coil channel) to "yes, active signalling object".
The feedback is enabled. As soon as the actuator updates a feedback object, a telegram is also actively transmitted to the bus. In the ETS, the "Transmission" flags are automatically set for the feedback objects.
- Set the parameter "Feedback for the active fan level" on the parameter page "Cx - fan feedback" to "yes, passive status object".
The feedback is enabled. The actuator updates only the feedback objects internally, and does not transmit any telegram. The object value can be read out via the bus at any time (ValueRead), as a result of which the actuator then transmits a response telegram (ValueResponse). In the ETS, the "Read" flags are automatically set for the feedback objects.
- Set the parameter "Feedback for the active fan level" on the parameter page "Cx - fan feedback" to "no".
The feedback for the active fan level is deactivated. The ETS hides the corresponding communication objects.

Setting the type of feedback

The type of feedback is configured in the ETS separately for each fan coil channel, and defines the data format for the feedback objects.

In order to set the data format, fan level feedback must be enabled.

- Set the parameter "Type of feedback" on the parameter page "Cx - fan feedback" (x = number of the fan coil channel) to "Fan levels via value".
The data format for the fan level feedback is defined as 1 byte. Only one communication object is visible in common for all fan levels of a channel. When the fan level is changed, the actuator always updates and transmits the current object value.
- Set the parameter "Type of feedback" on the parameter page "Cx - fan feedback" to "Fan levels individually".
The data format for the fan level feedback is defined as 1 bit. Separate objects are defined separately for each fan level. When the fan level is changed, the actuator updates and transmits only the object values that change.

Feedback for "Fan coil active"

By means of the feedback "Fan coil active" the actuator can indicate separately for each fan coil channel whether the fan and/or a valve of the corresponding channel is switched on. By evaluating or displaying this feedback it is possible, for example, to recognise quickly and reliably at a central location in a building whether ventilation or heating or cooling operation is actively in operation.

This feedback takes place via the 1-bit communication object "Feedback for fan coil active". This object is actively transmitting: As soon as the actuator of any of the outputs of a channel is switched on, a "1" telegram is transmitted to the bus. Consequently a "0" telegram is transmitted immediately as soon as all outputs of the channel are switched off. The feedback is updated in every state of operation of the channel, meaning that the real state is always returned. Thus switch-on or switch-off delays for the fan are also taken into account, for example.

- i** With valve protection the feedback "Fan coil active" is not generated if only one of the valves of a channel is open and no fan is running at that instant. With fan protection, on the other hand, the feedback is always generated.
- i** The feedback "Fan coil active" does not identify whether the channel concerned is heating or cooling, and what level the fan is running in.

Enabling "Fan coil active" feedback

The feedback for "Fan coil active" is configured in the ETS separately for each fan coil channel. If used, the parameters for the fan level feedback should be set first in the ETS.

- Set the parameter "Feedback object 'Fan coil active'" on the parameter page "Cx - fan feedback" (x = number of the fan coil channel) to "enabled".
The feedback function is enabled and the feedback object "Feedback for fan coil active" is visible.
- Set the parameter "Feedback object 'Fan coil active'" on the parameter page "Cx - fan feedback" (x = number of the fan coil channel) to "disabled".
The feedback function "Fan coil active" is deactivated.

Bus behaviour for the feedback telegrams

For the feedback telegrams "Active fan level" and "Fan coil active" it is possible to configure the bus behaviour for telegram transmission in greater detail in the ETS. As soon as the fan level feedback is parameterised as actively transmitting or the feedback "Fan coil active" is enabled, further parameters for configuration of the bus behaviour appear in the ETS.

Setting time delay for feedback after bus voltage return

It is possible to set a time delay for the actively transmitting feedback telegrams after bus voltage return (switching on of the bus voltage), and also after ETS programming. This can be useful, for example, in order to reduce the bus load if after a bus reset several devices are carrying out initialisation of their feedback objects at the same time. Here it is advisable to define different time delays in the devices, so that the transmission of the feedback telegrams is staggered in time.

For this purpose a channel-independent delay time can be defined in the actuator. Only after the parameterised time elapses are feedback telegrams for initialisation transmitted to the bus.

Whether the feedback telegrams "Active fan level" and "Fan coil active" should now be transmitted with a time delay after initialisation can be configured in the ETS in common for both feedback telegrams via the parameter "Time delay for feedback ... after bus voltage return" on the parameter page "Cx - fan feedback" (x = number of the fan coil channel). This setting is performed independently for each fan coil channel.

The delay time itself is configured independent of the channel on the parameter page "Times" (see chapter 4.2.4.2.2. Delay after bus voltage return).

The parameter "Time delay for feedback ... after bus voltage return" is only visible if the fan level feedback (actively transmitting) and/or the the feedback "Fan coil active" is enabled. Moreover, the parameter name changes dynamically depending on the enabled feedback telegrams.

- Set the parameter "Time delay for feedback ... after bus voltage return" to "Yes".
After the bus voltage supply is switched on or after ETS programming the feedback telegrams for the active fan level and "Fan coil active" are transmitted with a time delay.
- Set the parameter "Time delay for feedback ... after bus voltage return" to "No".
After the bus voltage supply is switched on or after ETS programming the feedback telegrams for the active fan level and "Fan coil active" are transmitted to the bus immediately after initialisation of the actuator.

- i** After a device reset the fan coil actuator always requires a short initialisation time before it is ready to function. This initialisation time of approx. 5 s is always in effect (even when the delay after bus voltage return is deactivated), and thus adds itself to the time set in the ETS.
- i** After bus voltage return or after ETS programming the actuator always transmits feedback telegrams for each channel, as long as the the objects are configured as actively transmitting. If only the mains voltage is switched on again (bus voltage remained switched on without interruption), then the fan coil actuator only transmits the feedback telegrams "active fan level" and "fan coil active" if outputs of the channel concerned are switched on as a result of the tracking of states after mains voltage return.
- i** In the event of a failure of the mains voltage supply, all relays of the actuator always drop out (contacts open), regardless of the state of the bus voltage. In this state the outputs can no longer be activated.
Because in this situation all valves and fans are switched off, the fan coil actuator updates its feedback telegrams "active fan level" and "fan coil active" accordingly (state "OFF" / "inactive") and also transmits the telegrams to the bus, so long as bus voltage is present.

Setting cyclical transmission of the feedback telegrams

When the bus voltage is switched on, it is possible to have the actuator transmit actively transmitting feedback telegrams cyclically. Cyclical transmission is performed based on a fixed time period, and is always in addition to and independent of telegram transmission for updating or requesting of the corresponding feedback objects.

The time for the cyclical transmission is defined in the actuator independent of the channel in the ETS on the parameter page "Times".

Whether the feedback telegrams "Active fan level" and "Fan coil active" should now be transmitted cyclically can be configured in the ETS in common for both feedback telegrams via the parameter "Cyclical transmission of the feedback ..." on the parameter page "Cx - fan feedback" (x = number of the fan coil channel). This setting is performed independently for each fan coil channel.

The cyclical transmission can only be configured if the fan level feedback (actively transmitting) and/or the feedback "Fan coil active" is enabled. Moreover, the parameter name changes dynamically depending on the enabled feedback telegrams.

- Set the parameter "Cyclical transmission of the feedback ..." to "Yes". On the parameter page "Times", configure the channel-independent "Time for cyclical transmission of the feedback telegrams" (0 minutes ... 23 hours 59 minutes).

The current object values of the feedback telegrams "Active fan level" and "Fan coil active" are also transmitted to the bus cyclically in addition to telegram transmission in case of an update or request. At the end of the cycle time all object values of a channel are always sent one immediately after the other. Therefore with the data format 1 bit up to 6 telegrams are transmitted for the fan level feedback alone (depending on the number of fan levels present). The telegram sequence is undefined.

After the bus voltage supply is switched on or after ETS programming, the starting of the cycle time begins only after the device initialisation time (approx. 5 s) plus the "Delay after bus voltage return" set in the ETS have elapsed. Consequently the actuator does not transmit cyclically during a delay after bus voltage return.

- Set the parameter "Cyclical transmission of the feedback ..." to "No".

Cyclical transmission is deactivated. The current object values of the feedback telegrams "Active fan level" and "Fan coil active" are transmitted to the bus only in case of an update or request. This means that when there is an update a telegram is only transmitted for feedback objects whose value has changed.

- i** In the event of a failure of the mains voltage the fan coil actuator updates its feedback telegrams "active fan level" and "fan coil active" accordingly (state "OFF" / "inactive") and also transmits the telegrams cyclically to the bus, so long as bus voltage is present.

- i** The setting "0 minutes 0 seconds" for the cycle time on the parameter page "Times" deactivates the cyclical transmission completely for all channels!

Configuring the request for feedback

Transmission of the feedback telegrams of a channel can be initiated via the bus at any time. For this purpose each fan coil channel has the 1-bit communication object "Request feedback". As soon as any switching telegram ("0" or "1") is received via this object, the actuator immediately initiates transmission of the feedback telegrams "Active fan level" and "Fan coil active".

The feedback request only affects actively transmitting feedback objects.

A feedback request can only be configured if the fan level feedback (actively transmitting) and/or the feedback "Fan coil active" is enabled. Moreover, the parameter name changes dynamically depending on the enabled feedback telegrams.

- Set the parameter "Request object for feedback telegram(s) ..." on the parameter page "Cx - fan feedback" (x = number of the fan coil channel) to "enabled".

The request object is enabled. In case of a request all actively transmitting feedback object values of a channel are transmitted one immediately after the other. With the data format 1 bit up to 6 telegrams are transmitted for the fan level feedback alone (depending on the number of fan levels present). The telegram sequence is undefined.

- Set the parameter "Request object for feedback telegram(s) ..." on the parameter page "Cx - fan feedback" to "disabled".

The feedback request is deactivated, the object is hidden in the ETS. The current object values of the feedback telegrams "Active fan level" and "Fan coil active" are transmitted to the bus only in case of an update or via cyclical transmission.

- i** Also the actor answers no request telegrams for the feedback telegrams during the delay time after bus voltage return. After bus voltage return, the feedback telegrams are transmitted automatically to the bus after the end of the delay time, if actively transmitting.
- i** The cyclical transmission of the feedback telegrams is not affected by a feedback request.

4.2.4.3.6 Manual fan control

Manual fan control

The manual fan control makes it possible to control the fan in the fan coil unit independent of the command value specification of a room thermostat. This enables requirements-oriented ventilation of a room in any desired, manually specified fan level. It is possible to define whether the manual ventilation can be performed only with, or also without additional heating / cooling. The manual specification for fan control can be made via a KNX/EIB push-button or via an operating panel, for example (figure 28). Even with manual fan control, the valves are always controlled via the command values, for example from a room thermostat.

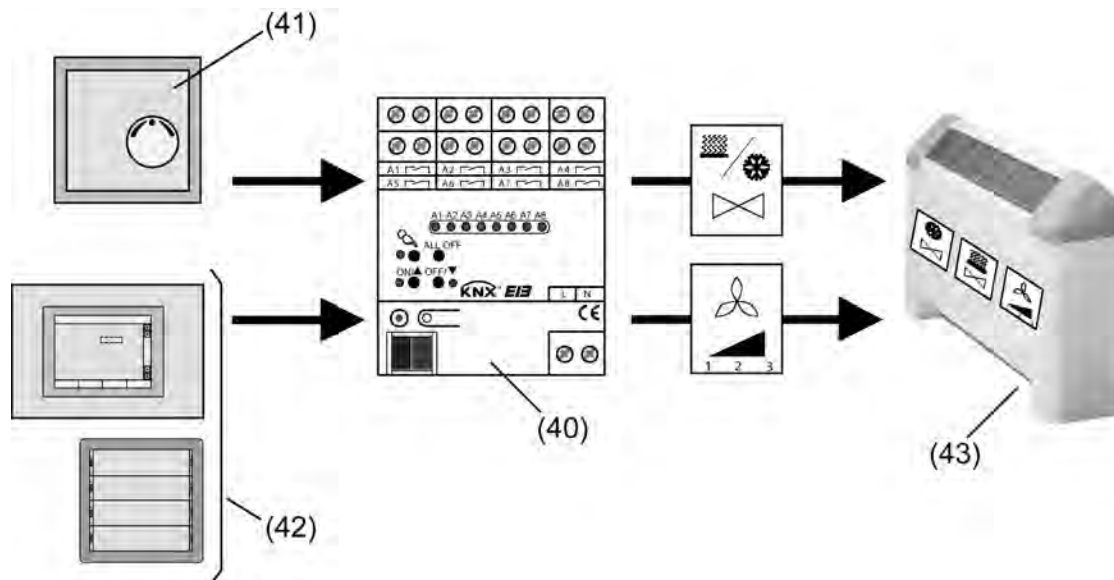

Figure 28: Principle of manual fan control

(40) Fan coil actuator

(41) Room thermostat

(42) Push-button and/or operating panel for manual control of the fan

(43) Fan coil unit

Enabling manual fan control

The manual fan control function can be enabled in the ETS separately for each fan coil channel.

- Set the parameter "Manual fan control" on the parameter page "Cx - manual fan control" (x = number of the fan coil channel) to "enabled".

The manual fan control is enabled for the corresponding channel. Additional parameters and objects become visible.

- Set the parameter "Manual fan control" on the parameter page "Cx - manual fan control" to "disabled".

The manual fan control is deactivated.

Configuring activation of manual fan control

The fan can only be controlled manually if the function of the manual fan control has been activated in the fan coil actuator via the bus. The manual fan level control can be activated and deactivated here in two different ways...

- Activation and deactivation via a separate 1-bit communication object,
- Activation via the object which also sets the fan level directly, and deactivation via a separate 1-bit communication object,

The manual fan control must have been enabled beforehand in the ETS.

- Set the parameter "Activation of manual fan control" on the parameter page "Cx - manual fan control" (x = number of the fan coil channel) to "via object 'Manual fan control active/inactive'".

The communication object "Manual fan control active/inactive" is visible in the ETS. The manual fan control is activated by this object via an "ON" telegram and deactivated via an "OFF" telegram. While a function is activated the fan can be controlled manually using the control specification (object "Manual fan control specification")

When manual fan control is deactivated, normal operation is activated again if no function with a higher priority (e.g. disabling function) is active. In normal operation the fan control actuator controls the outputs and mode of operation according to the last command value received. Consequently all outputs are switched off if no command value or valid mode of operation has been received at the instant that manual fan control is deactivated.

As long as manual fan control is deactivated, any telegrams that are received for manual control specification of the fan will be rejected.

This configuration can be useful if manual control is enabled at a central point in the building, for example by the concierge. The actual manual control of the fan coil unit is then performed separately in each room depending on requirements, for example using a push-button.

- Set the parameter "Activation of manual fan control" on the parameter page "Cx - manual fan control" to "via object 'Manual fan control specification'".

Manual fan control is activated as soon as any telegram is received via the object "Manual fan control specification", independently of the data format that is set. The telegram is also evaluated immediately as a control specification, meaning that the fan is switched to a fan level according to the specification. As long as manual fan control is active, the fan can be controlled using the object "Manual fan control specification".

To deactivate manual fan control, the 1-bit object "Deactivate manual fan control" must have an "OFF" telegram written to it. An "ON" telegram to this object shows no reaction.

When manual fan control is deactivated, normal operation is activated again if no function with a higher priority (e.g. disabling function) is active. In normal operation the fan control actuator controls the outputs and mode of operation according to the last command value received. Consequently all outputs are switched off if no command value or valid mode of operation has been received at the instant that manual fan control is deactivated.

This configuration can be useful if a channel of the actuator is used primarily only for ventilation. Manual control of the fan coil unit is then performed separately in each room, for example using a push-button. Manual control can be deactivated at certain times of the day at a central point in the building, e.g. by the concierge in the evening hours.

This configuration also makes it possible, however, to supplement manual control with a heating or cooling system, for example at certain times of the year.

- i** With the setting "via object 'Manual fan control active/inactive'":

As long as manual fan control is deactivated, any telegram with the value "OFF" has no effect on the object "Manual fan control active/inactive".

With the setting "via object 'Manual fan control specification'":

As long as manual fan control is deactivated, any telegram with the values "ON" or "OFF" has no effect on the object "Deactivate manual fan control".

- i** The state of the manual fan control (activated / deactivated) is saved in non-volatile memory in the actuator together with the last manual level specification in the event of bus or mains voltage failure (depending on which of these voltages fails first). Any manual fan control active before the bus or mains voltage failure is resumed after bus or mains voltage return, if the parameter "Behaviour after bus or mains voltage return" is set to "Valve & fan states as before bus/mains voltage failure".
Moreover, manual fan control can be activated after bus or mains voltage return and also after ETS programming independent of the parameter "Behaviour after bus or mains voltage return" (see "Presetting behaviour for manual fan control after bus or mains voltage return" below).

Setting the data format for manual fan control

When manual fan control is activated, the fan of the fan coil unit can be controlled directly via the object "Manual fan control specification". The data format for this object can be configured in the ETS to 1 bit or alternatively to 1 byte, thus allowing control of the fan levels either via a switching direction specification or via a value specification. In this manner the manual fan control can be adapted very flexibly to the operating equipment (e.g. push-button or operating panel).

The manual fan control must have been enabled beforehand in the ETS.

- Set the parameter "Fan level change-over with manual specification via" on the parameter page "Cx - manual fan control" (x = number of the fan coil channel) to "Switching direction object (1-bit)".

The data format of the specification object is set to 1 bit switching direction (KNX DP type 1.007), and corresponds for example to the format of a push-button that transmits simple switching telegrams to the bus when a rocker switch is actuated (button 1 ON, button 2 OFF).

At the time of activation or during manual fan control the last fan level that was set is increased gradually one level at a time (object value "ON") or decreased (object value "OFF"). The fan level can be increased until the maximum number of fan levels or the limitation level is reached. It can be decreased all the way to switching-off of the fan.

- Set the parameter "Fan level change-over with manual specification via" on the parameter page "Cx - manual fan control" to "Value object (1-byte)".

The data format of the specification object is set to 1 byte value specification (KNX DP type 5.010).

At the time of activation or during manual fan control the fan level corresponding to the value of the last specification telegram is set. If the value of the specification object exceeds the maximum number of fan levels or, in case of active level limitation, it is larger than the limitation level, then the maximum possible or limited level value is set. An object value of "0" switches off both the fan and the valves, if they were last switched on. The value specification can also be performed if manual fan control is deactivated. In this case the actuator saves the value temporarily and tracks it as soon as the manual control is activated. Immediately after a device reset (bus and mains voltage failure or ETS programming) the state of the value specification object is always "0" (fan and valves OFF).

- i** If the fan is switched on using manual control, the actuator first carries out the switch-on level, if it is configured in the ETS. Only after the end of the dwell time for the switch-on level does it switch to the manually specified fan level.
- i** In the case of fan level control with the level principle the "Dwell time for level change-over" configured in the ETS has no effect if the manual fan control is activated via a 1-bit switching direction object. This means that the fan outputs can be changed-over with no delay, for example if the push-button is pressed several times.
In contrast, when the fan levels are controlled via a value object the dwell time is always effective for a level change-over across more than one level.
- i** A switch-on delay of the fan for heating or a switch-off delay of the fan for cooling has no effect for manual fan control if the valves are closed, i.e. if neither heating nor cooling is being performed. If the valves are, however, opened during manual fan control, then switch-on or switch-off delays for the fan are also taken into account.

i No manual fan control is possible during fan protection.

Setting the functional principle for manual fan control

The fan coil actuator makes a distinction between two functional principles of the manual fan control, which can be configured in the ETS as alternatives to each other.

Thus manual fan control can on the one hand be activated completely independently of the command values. In this case, manual ventilation without active heating or cooling as a purely ventilation function is possible, i.e. even when the valves are closed.

On the other hand, manual fan control can only be performed if the heating or cooling valve is open, i.e. if active heating or cooling is being performed.

The manual fan control must have been enabled beforehand in the ETS.

- Set the parameter "Manual fan control only with active heating / cooling" on the parameter page "Cx - manual fan control" (x = number of the fan coil channel) to "No".

Manual fan control can be performed independently of heating or cooling operation, i.e. even when the valves are closed. Changes in the command value of a room thermostat have no effect on the fan level, so long as the manual fan control is activated.

The command values, if necessary in connection with the object "Heating/cooling change-over", only affect the control of the valves. Thus a valve is opened if the command value of the active mode of operation is not equal to 0 %. However, this only takes place if the fan is also switched on at this instant using manual control. If the fan is switched off, then the valves also remain switched off in order to protect the fan coil unit against overheating or freezing (figure 29).

A change in the mode of operation (heating or cooling) is possible without any change in the state of the fan level.

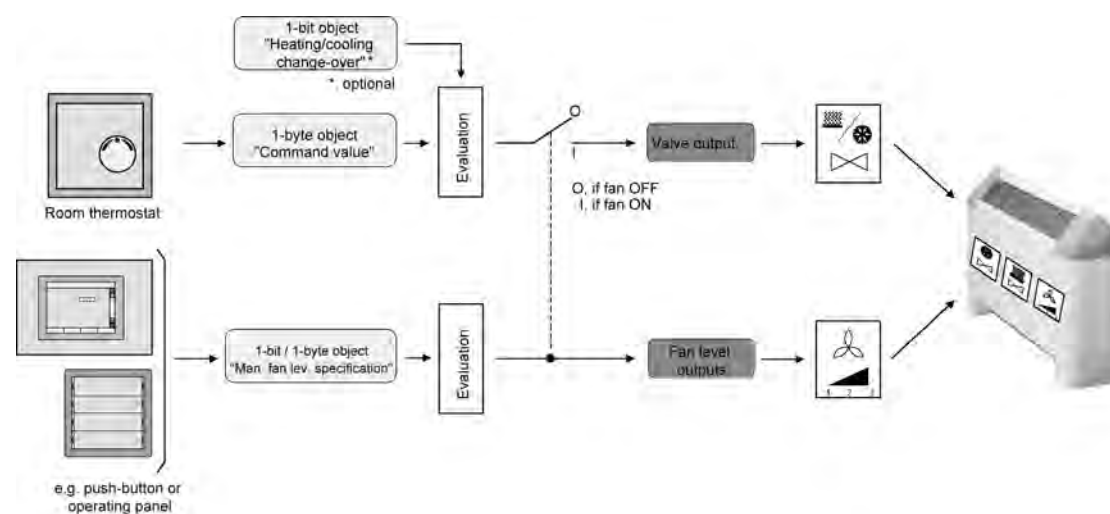

Figure 29: Schematic diagram for manual fan control independent of active heating / cooling (simplified depiction)

- Set the parameter "Manual fan control only with active heating / cooling" on the parameter page "Cx - manual fan control" to "Yes".

The manual fan control can only be performed if the valves for heating or cooling are opened, i.e. the command value of the active mode of operation is greater than 0 % and a valid mode of operation (heating / cooling) has been specified. As long as the active command value is 0 % or no mode of operation has been specified yet, the fan can never be switched on using manual control. In this case manual control can be activated, but any level specification is ignored, meaning that the fan remains switched off (figure 30).

Any manual specification of the fan level only takes effect if the command value of the active mode of operation is greater than 0 %. In this case the fan level can only be selected manually; changes in the command value for a room thermostat have no effect on the fan level, so long as the command value is not 0 %.

If the command value drops to 0 %, the fan and thus also the valves are always switched off; the manual fan level specification is thus ignored once again. If the command value subsequently becomes greater than 0 %, a new manual specification of the fan level must always be performed (in this case the old specification is not tracked)! This is also the case if the manual fan control is activated automatically after bus or mains voltage return (e.g. if states are tracked).

In case of an activated manual fan control and command values greater than 0 % the valves of a channel are only switched on if the fan is also switched on manually.

If the fan is switched off via manual control, the actuator also always switches the valve off, regardless of the command value.

If the mode of operation is changed (heating <-> cooling) while manual fan control is activated, the fan is switched off by forced control. In the case of mode of operation change-over via the change-over object, the fan can only be switched on once again via manual control if a command value has also been specified for the new mode of operation.

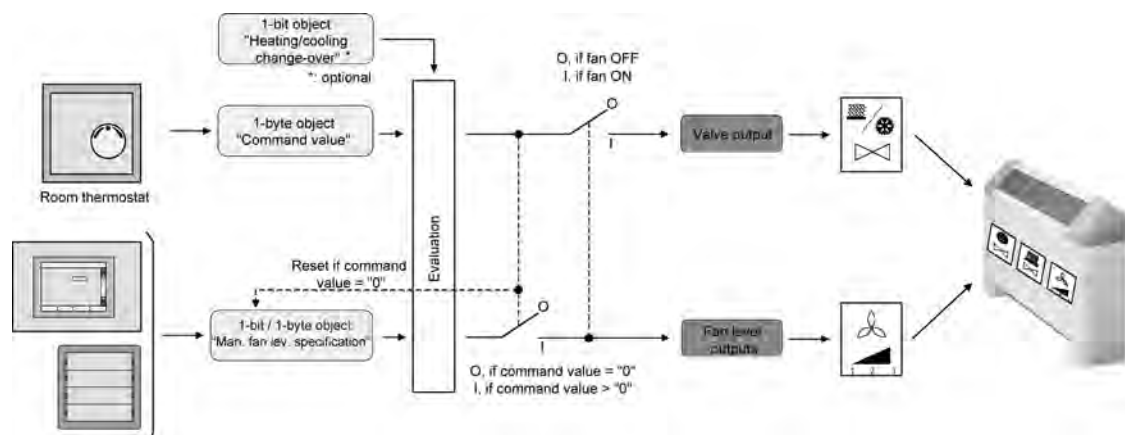

Figure 30: Schematic diagram for manual fan control depending on active heating / cooling (simplified depiction)

- i** If the fan is switched on in manual control after a new command value specification or via a new manual specification, the actuator first carries out the switch-on level, if it is configured in the ETS. Only after the end of the dwell time for the switch-on level does it switch to the manually specified fan level.
- i** In both functional principles, any fan switched on by the manual fan level control influences the room thermostat function if the command value is not equal to 0 %. More or less heating or cooling is performed, because the valve corresponding to the mode of operation remains open, but the fan level is no longer dependent on the command value.

- i** A switch-on delay of the fan for heating or a switch-off delay of the fan for cooling has no effect for manual fan control if the valves are closed, i.e. if neither heating nor cooling is being performed. Manual fan control without the valve being switched on is only possible with the configuration "Manual fan control only with active heating / cooling" = "No". If the valves are, however, opened during manual fan control, then switch-on or switch-off delays for the fan are also taken into account. This behaviour results from the configuration "Manual fan control only with active heating / cooling" = "No" or "Yes".

Configuring feedback for manual fan control

The manual fan control of the fan coil actuator has an individual status feedback for each fan coil channel. The 1-bit feedback object appears as soon as manual control is enabled in the ETS.

This feedback object is used to transmit an "ON" telegram actively to the bus, after which the manual fan control is activated depending on the configuration in the ETS either via the object "Manual fan control active/inactive" or via the the object "Manual fan control specification". It is irrelevant here whether activation also causes the fan to be switched on or not (if, for example, the command value is still 0 %).

The feedback object is used to transmit an "OFF" telegram to the bus, after which the manual fan control is terminated via the object "Manual fan control active/inactive" or "Deactivate manual fan control".

- Set the parameter "Manual fan control" on the parameter page "Cx - Manual fan control" (x = number of the fan coil channel) to "enabled".
The manual fan control is enabled for the corresponding channel (see "Enabling manual fan control"). The 1-bit feedback object "Manual fan control feedback" becomes visible.
 - Set the parameter "Manual fan control" on the parameter page "Cx - manual fan control" to "disabled".
The manual fan control is deactivated for the corresponding channel (see "Enabling manual fan control"). The 1-bit feedback object is not visible.
- i** In the event of bus voltage return or after ETS programming the feedback telegrams of the manual fan control of both channels are transmitted actively to the bus. Transmission only takes place after the end of the "Delay after bus voltage return" (see "Delay after bus voltage return").
If only the mains voltage is switched on again (bus voltage remained switched on without interruption), then the fan coil actuator does not transmit the feedback telegrams of the manual fan control. In this case the transmission takes place if the mains voltage return activates the manual control of the fan (see chapter 4.2.4.3.1. Reset and initialisation behaviour) (see page 88-89).
- i** The feedback of the manual fan control can, for example, be used to control a status LED on a push-button or a status indication on an operating panel, or also to disable a room thermostat.

Presetting behaviour for manual fan control after bus or mains voltage return

It is possible to activate manual fan control automatically after return of bus or mains voltage or after ETS programming. Automatic activation of the manual fan control is useful, for example, if a channel of the actuator is primarily used only for multiple-level ventilation, and the control is to be activated immediately after a device reset.

The manual fan control must have been enabled beforehand in the ETS. Moreover, the parameter "Manual fan control only with active heating / cooling" has to be configured to the setting corresponding to the application, because this parameter also affects the behaviour of the manual fan control after bus or mains voltage return or after ETS programming.

- Set the parameter "Activate manual fan control after bus or mains voltage return ?" on the parameter page "Cx - manual fan control" (x = number of the fan coil channel) to "No".

Manual fan control is not activated automatically after return of bus or main voltage. The "behaviour after bus or mains voltage return" is performed which was configured in the ETS separately for each fan coil channel on the parameter page "Channel x - general".

Special case: If the parameter "Behaviour after bus or mains voltage return" is set to "Valve & fan states as before bus/mains failure", and if manual fan control was activated before the bus or mains voltage failure, then after bus or mains voltage return the actuator also reactivates the manual fan control, including the saved specified values for the fan level.

After ETS programming, manual fan control is always deactivated in this configuration.

- Set the parameter "Activate manual fan control after bus or mains voltage return ?" on the parameter page "Cx - manual fan control" to "Yes".

The manual fan control is activated under forced control after return of bus or mains voltage or after ETS programming. For the fan coil channel concerned, the "behaviour after bus or mains voltage return" which was configured in the ETS on the parameter page "Channel x - general" is not performed.

Special case: If the parameter "Behaviour after bus or mains voltage return" is set to "Valve & fan states as before bus/mains failure", and if manual fan control was activated before the bus or mains voltage failure, then after bus or mains voltage return the actuator reactivates the manual fan control, including the saved specified values for the fan level.

- i** Manual fan control is always deactivated again via the object "Manual fan control active/ inactive" or "Deactivate manual fan control" (see "Configuring activation of manual fan control"). This also applies for the case that manual control is activated automatically after bus or mains voltage return or after ETS programming.
- i** For the setting "Manual fan control only with active heating / cooling" = "Yes" and for the case that manual fan control is activated / tracked automatically after bus or mains voltage return, the following must be observed:
If a command value of 0 % is tracked after bus or mains voltage return, the actuator ignored the saved and tracked state of the manual fan level specification. In this case, even though manual control is activated, the fans and the valves are still switched off, independently of the old manual specification.
If the command value subsequently becomes greater than 0 %, a new manual specification of the fan level must always be performed (in this case the old, previously saved specification is not tracked)!
The same is applicable if no mode of operation has been received in the fan coil system with mode of operation change-over after bus or mains voltage return.

4.2.4.3.7 Cyclical command value monitoring

Cyclical command value monitoring

The fan coil actuator makes it possible to monitor the active command value for each fan coil channel. This monitoring checks whether command value telegrams have been received by the fan coil actuator within a time interval that can be defined in the ETS. If there are no telegrams during the monitoring time, then the actuator can set the valve and fan outputs to a state parameterised in the ETS. As a rule, a room thermostat transmits its command values cyclically to the bus if cyclical monitoring has been activated in the fan coil actuator (figure 31).

The monitoring time can be configured in the fan coil actuator from 1 minute to 23 hours 59 minutes. During the monitoring time the fan coil actuator expects at least one command value telegram. If a telegram is received, then the actuator resets the monitoring time and restarts the time interval.

The cyclical monitoring begins immediately after commissioning via the ETS, or after the bus and mains voltage is switched on.

If no telegram is received before the end of the monitoring time, the fan coil actuator immediately assumes the valve and fan level state (fault state) configured in the ETS. Here the actuator can transmit a 1-bit fault message to the bus, which can be evaluated "in the bus" by means of other bus devices for further processing.

Only when a new command value telegram is received does the actuator reset the monitoring time, reset it, and resets the valve and fan level states in accordance with the command value specification. The fault message is also retracted here by having the actuator send an inverted fault message telegram to the bus.

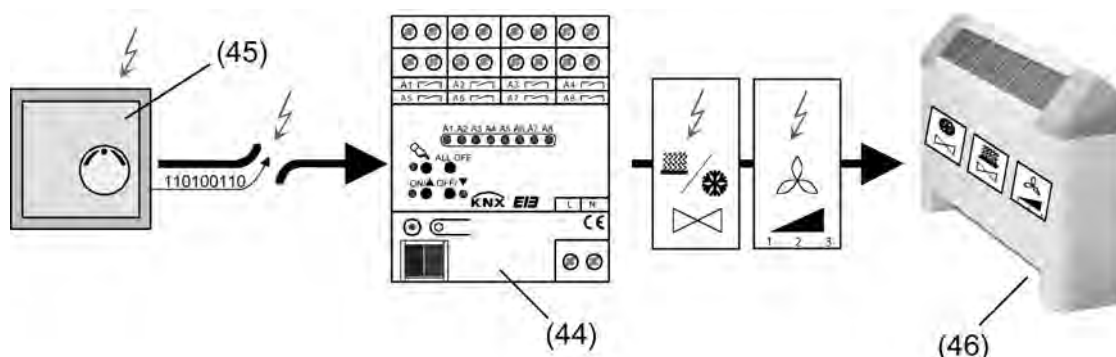

Figure 31: Principle of cyclical command value monitoring in the event of a fault (e.g. open circuit)

(44) Fan coil actuator in fault state

(45) Faulty room thermostat with cyclical telegram transmission of the command values

(46) Fan coil unit

Together with the command value specification via the bus, the cyclical monitoring has the lowest priority in the fan coil actuator. As soon as a function with a higher priority is activated, for example manual fan control, a disabling function, or manual control, then the actuator interrupts the cyclical monitoring. Only after all functions with a higher priority are deactivated does the actuator restart the monitoring time.

If a fault message has been transmitted to the bus before the beginning of a function with a higher priority, then the actuator automatically retracts the fault message, if the monitoring time is re-started at the end of the function with the highest priority.

The command values continue to be monitored while a fan level limitation is active. If in this situation the cyclical monitoring detects missing command values, then the fan coil channel immediately assumes the valve and fan level state configured in the ETS, however the fan level is limited by the limitation value of the active fan level limitation.

- i** No cyclical monitoring is performed during a bus or mains voltage failure; the monitoring time is re-started upon bus or mains voltage returns and after every ETS programming. After bus or mains voltage return any fault message previously sent to the bus is retracted by transmitting an "OFF" telegram.
- i** For fan coil systems "2- & 4-pipe heating / cooling via change-over object": Basically only the command value belonging to the mode of operation last specified (heating or cooling) is cyclically monitored. The communication object for change-over of the mode of operation is not monitored by the cyclical monitoring. A change or an initial specification of the mode of operation by means of a telegram to the change-over object restarts the monitoring time, however, and also results in cancellation of any fault message previously transmitted and of the fault state itself.

Enabling cyclical monitoring

In order to be able to use the cyclical monitoring for a fan coil channel, it has to be enabled separately in the ETS for each channel.

- Set the parameter "Cyclical monitoring of the command values" on the parameter page "Cx - cyclical monitoring" (x = number of the fan coil channel) to "enabled".

Cyclical monitoring is enabled and the parameters for the function are visible in the ETS. When monitoring is enabled, in fault-free operation the command value object active depending on the mode of operation must have telegrams transmitted to it cyclically.

- Configure the parameter "Cyclical monitoring of the command values" on the parameter page "Cx - cyclical monitoring" to "deactivated".

The cyclical monitoring is completely disabled. No telegram monitoring of the command value objects is performed.

Configuring the reaction at the end of the monitoring time

If the fan coil actuator does not receive any command value telegram of the active mode of operation within the time interval of the monitoring time, then the fan coil channel immediately enters the fault state, provided that no function with a higher priority is activated at that instant. The fault state is valve and fan level state defined in the ETS separately for each fan coil channel. The possible parameter settings are dependent on the configured fan coil system.

The cyclical monitoring must have been enabled already.

- Set the parameter to "no reaction".

No special fault state is set. The current valve position and fan level is adopted with no changes after the end of the monitoring time.

Any actions still in progress at this instant (e.g. switch-on or switch-off delay for the fan) will still be completely finished.

- Set the parameter to "Switch off all valve & fan outputs".

For the fault state all valves are closed and the fan is switched off.

- Set the parameter to "Heating with fan level". Configure the necessary fan level in the parameter "Fan level". This setting cannot be selected in the fan coil systems "2-pipe cooling" and "2-pipe heating/cooling via change-over object".

In the fault state the heating valve is opened. The fan is switched to the parameterised level. In fan coil systems with the combined "heating/cooling" mode of operation the opening of the heating valve causes the cooling valve to close automatically, if it is open at the instant that the fault state is activated.

- Set the parameter to "Cooling with fan level". Configure the necessary fan level in the parameter "Fan level". This setting cannot be selected in the fan coil systems "2-pipe heating" and "2-pipe heating/cooling via change-over object".

In the fault state the cooling valve is opened. The fan is switched to the parameterised level. In fan coil systems with the combined "heating/cooling" mode of operation the opening of the cooling valve causes the heating valve to close automatically, if it is open at the instant that the fault state is activated.

- Set the parameter to "Specified mode of operation with fan level". Configure the necessary fan level in the parameter "Fan level". This setting can only be selected in the fan coil system "2-pipe heating/cooling via change-over object".

The common valve for heating/cooling is opened in the fault state, if it is not open already. The fan is switched to the parameterised level.

The cyclical monitoring begins immediately after commissioning via the ETS, or after the bus and mains voltage is switched on. In this case the parameterised "Reaction at the end of the monitoring time" is only executed if a valid mode of operation has also been specified via the object "Heating/cooling change-over" and the monitoring time has elapsed at least one additional time. This is because specifying the mode of operation via a telegram to the switching object after initialisation results in a reset of the monitoring time, and if necessary first the execution of the behaviour after bus or mains voltage return (for parameterisation the behaviour as before bus/mains voltage failure).

- i** The parameter settings "Heating with fan level" and "Cooling with fan level" cannot be selected in the fan coil system "2-pipe heating/cooling via change-over object", because the heating or cooling medium in the combined pipe for the fan coil actuator is not known, and therefore specification of the mode of operation can only be made "from outside".

Configuring the fault message for cyclical monitoring

If in the course of cyclical monitoring no command value telegram is received before the end of the monitoring time, the fan coil actuator immediately assumes the valve and fan level state (fault state) configured in the ETS. Here the actuator can transmit a 1-bit fault message to the bus, which can for example be evaluated by means of other bus devices for further processing. If new command value telegrams are received or the fault state of the cyclical monitoring is overridden by a different function of the actuator, the actuator retracts the fault message.

The telegram polarity of the fault message is defined: An "ON" telegram is transmitted if a fault state has been detected. Similarly, an "OFF" telegram is transmitted to the bus as soon as a fault state has been reset.

The cyclical monitoring begins immediately after commissioning via the ETS, or after the bus and mains voltage is switched on. The fan coil actuator transmits the fault message to the bus automatically and with active transmission as soon as the monitoring time has elapsed and no command value telegram has been received.

Transmission of the fault message also takes place if the parameterised "Reaction at the end of the monitoring time" cannot be performed because, for example, no mode of operation has been specified yet for 2-pipe systems with heating/cooling, or a function with a higher priority (e.g. disabling function) is activated at that instant.

After bus voltage return or after ETS programming the telegram for the fault message ("OFF" state) is transmitted automatically to the bus with a delay, depending on the parameter "Delay after bus voltage return". Consequently, after the return of the bus supply voltage any fault message previously transmitted to the bus is retracted by transmitting an "OFF" telegram. If only the mains voltage is switched on again (bus voltage remained switched on without interruptions), the fan coil actuator transmits the "OFF" fault message only if a fault state was detected before the mains failure, and therefore an "ON" fault message was transmitted.

The cyclical monitoring must have been enabled already.

- Set the parameter "Fault message at the end of the monitoring time" on the parameter page "Cx - cyclical monitoring" (x = number of the fan coil channel) to "enabled".

The fault message is enabled and the communication object "Fault message for cyclical monitoring" becomes visible in the ETS. As soon as the monitoring time ends without a command value telegram having been received via the specific command value object that is active, the actuator transmits a fault message to the bus.

- Set the parameter "Fault message at the end of the monitoring time" on the parameter page "Cx - cyclical monitoring" to "disabled".
The fault message is completely deactivated. In the event of a command value fault, if necessary only the "Reaction at the end of the monitoring time" parameterised in the ETS is executed.
- ❗ The cyclical monitoring has no effect during a higher function (e.g. disabling, manual control). If, however, the monitoring time elapses during one of these functions, a fault message is transmitted to the bus, if so parameterised in the ETS.
- ❗ In a 2-pipe fan coil system with a change-over object for heating/cooling, after a device reset a valid mode of operation must first be specified so that the parameterised "Reaction at the end of the monitoring time" can be executed. If a mode of operation has still not been specified after a reset, then a fault message is transmitted to the bus after the end of the monitoring time to indicate that there is a fault in the telegram transmission of the command values.
- ❗ For fan coil systems "2- & 4-pipe heating / cooling via change-over object":
A change or an initial specification of the mode of operation by means of a telegram to the change-over object restarts the monitoring time and also results in cancellation of any fault message previously transmitted and of the fault state itself.

4.2.4.3.8 Disabling function

Disabling function

The fan coil actuator makes it possible to disable each of its fan coil channels via a bus telegram. During the disabling the valve and fan outputs can be set to a state parameterised in the ETS, and can no longer be controlled via the bus. In this manner it is possible to place the valves or the fan in a locked stated, for example for servicing purposes (figure 32). The outputs can then only be controlled via manual control directly on the device. The behaviour of the valve or fan outputs at the end of the disabling can also be set, so that the connected fan coils can enter a defined state when they switch back to normal operation.

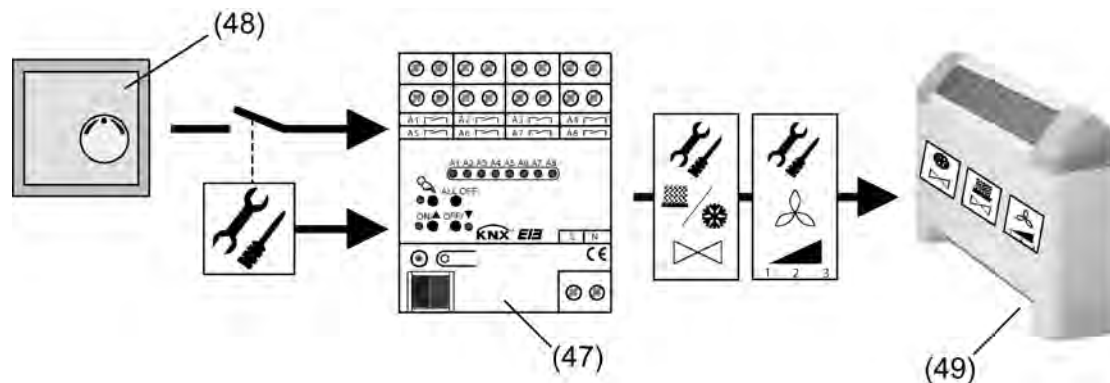

Figure 32: Principle of the disabling function - example showing a maintenance interlock

(47) Disabled fan coil actuator

(48) Room thermostat

(49) Fan coil unit

Enabling the disabling function

In order to be able to use the disabling function for a fan coil channel, it has to be enabled separately in the ETS for each channel.

- Set the parameter "Disabling function" on the parameter page "Cx - disabling function" (x = number of the fan coil channel) to "enabled".

The disabling function is enabled and the disabling object and the disabling parameter become visible in the ETS.

- Configure the parameter "Disabling function" on the parameter page "Cx - disabling function" to "deactivated".

The disabling function is disabled. The disabling object is hidden.

Setting the polarity of disabling object

The disabling function is activated and deactivated via the separate 1-bit communication object "Disabling function". The telegram polarity for this object can be set.

The disabling function must be enabled.

- Set the parameter "Polarity of the disabling object" on the parameter page "Cx - disabling function" (x = number of the fan coil channel) to the required telegram polarity.

The disabling function is activated via a telegram value according to the parameterisation ("disabled" state), and deactivated again via the inverted telegram value ("enabled" state).

- i** The disabling function is always deactivated after a device reset (bus or mains voltage return, ETS programming). With the setting "1 = enabled; 0 = disabled", after a device reset a "0" telegram has to be received in order for the disabling to be activated.

Setting the behaviour at the beginning of the disabling function

The behaviour at the beginning of a disabling function can be defined in the ETS independently for each channel using the parameter "Reaction at the beginning of the disabling function". The possible parameter settings are dependent on the configured fan coil system.

Bus control of the outputs is always locked at the beginning of a disabling function so that in all fan coil systems any command value change received via the bus does not result in any change in the states of the outputs.

The disabling function must be enabled.

- Set the parameter to "no reaction".

The current valve position and fan level at the beginning of the disabling is adopted with no changes in the disabling. Any mode of operation change-over received via the bus does not result in any change in the states of the outputs during the disabling.

If the disabling is activated at the instant that a switching process or delay is running, or processing of a switch-on level, then the actuator still finishes the process completely.

- Set the parameter to "Switch off all valve & fan outputs".

At the beginning of the disabling all valves are closed and the fan is switched off. Any mode of operation change-over received via the bus does not result in any change in the states of the outputs.

- Set the parameter to "Heating with fan level". Configure the necessary fan level in the parameter "Fan level". This setting cannot be selected in the fan coil systems "2-pipe cooling" and "2-pipe heating/cooling via change-over object".

At the beginning of the disabling the heating valve is opened. The fan is switched to the parameterised level. In fan coil systems with the combined "heating/cooling" mode of operation the opening of the heating valve causes the cooling valve to close automatically, if it is open at the instant the disabling is activated. Any mode of operation change-over received via the bus does not result in any change in the states of the outputs during the disabling.

- Set the parameter to "Cooling with fan level". Configure the necessary fan level in the parameter "Fan level". This setting cannot be selected in the fan coil systems "2-pipe heating" and "2-pipe heating/cooling via change-over object".

At the beginning of the disabling the cooling valve is opened. The fan is switched to the parameterised level. In fan coil systems with the combined "heating/cooling" mode of operation the opening of the cooling valve causes the heating valve to close automatically, if it is open at the instant the disabling is activated. Any mode of operation change-over received via the bus does not result in any change in the states of the outputs during the disabling.

- Set the parameter to "Specified mode of operation with fan level". Configure the necessary fan level in the parameter "Fan level". This setting can only be selected in the fan coil system "2-pipe heating/cooling via change-over object".

The common valve for heating/cooling is opened at the beginning of the disabling, if it is not open already. The fan is switched to the parameterised level.

During the disabling the fan coil actuator detects changes in the mode of operation via the change-over object. When there is a mode of operation change-over the actuator initially switches its fan level outputs off, taking into account the level change-over and any switch-off delay if necessary. The valve is also closed during the switch-off procedure. Only after that does the actuator open the valve again and switch on to the required fan level (taking any switch-on level into account if necessary). This procedure is necessary taking into account the delay times for the fan in order not to blow incorrectly climate-controlled air into the room in case of a change in the heating or cooling medium in a combined pipe.

If the mode of operation is not known at the instant the disabling is activated, i.e. no telegram has been received yet via the change-over object, then the channel concerned remains completely switched off in the disabling until a valid mode of operation is received.

- i** The parameter settings "Heating with fan level" and "Cooling with fan level" cannot be selected in the fan coil system "2-pipe heating/cooling via change-over object", because the heating or cooling medium in the combined pipe for the fan coil actuator is not known, and therefore specification of the mode of operation can only be made "from outside".
- i** During a disabling the valve and fan level outputs of the disabled fan coil channel can be operated and thus changed exclusively via manual control on the device. This overrides the behaviour specified at the beginning of the disabling function.
- i** When a disabling function is activated, a switch-on level and also switch-on and switch-off delays of a channel are taken into account for all settings, if so set in the ETS.
- i** A level limitation has no effect on the corresponding fan coil channel during a disabling function. A level limitation is only taken into account again at the end of a disabling function, if the limitation was activated via a bus telegram before or during the disabling.
- i** The cyclical monitoring has no effect during a disabling function. If, however, the monitoring time elapses during a disabling function, a fault message is transmitted to the bus, if so parameterised in the ETS.
- i** The fan and valve protection is interrupted at the beginning of a disabling function, and is not performed during the disabling. The 24-hour elapsed-time meters of the protection functions are restarted at the end of the disabling function.

Setting the behaviour at the end of the disabling function

The behaviour at the end of a disabling function can be defined in the ETS independently for each channel using the parameter "Reaction at the end of the disabling function". The possible parameter settings are dependent on the configured fan coil system.

Bus control of the outputs is always enabled again at the end of the disabling.

The disabling function must be enabled.

- Set the parameter to "no reaction".
The valve position and fan level set at the beginning of the disabling is retained until a new command value and if necessary a mode of operation change-over is received, or until activation of a function with a lower priority (e.g. manual fan control). If "no reaction" is also parameterised at the beginning of the disabling, then at the end of the disabling the actuator retains the channel state that was set before the disabling.
If the disabling is deactivated at the instant that a switching process or delay is running, or processing of a switch-on level, then the actuator still finishes the process completely.
- Set the parameter to "Switch off all valve & fan outputs".
At the end of the disabling all valves are closed and the fan is switched off. This state remains until a new command value and if necessary a mode of operation change-over is received, or until activation of a function with a lower priority (e.g. manual fan control).
- Set the parameter to "Heating with fan level". Configure the necessary fan level in the parameter "Fan level". This setting cannot be selected in the fan coil systems "2-pipe cooling" and "2-pipe heating/cooling via change-over object".
At the end of the disabling the heating valve is opened. The fan is switched to the parameterised level. In fan coil systems with the combined "heating/cooling" mode of operation the opening of the heating valve causes the cooling valve to close automatically, if it is open at the instant of enabling. This state remains until a new command value and if necessary a mode of operation change-over is received, or until activation of a function with a lower priority (e.g. manual fan control).
- Set the parameter to "Cooling with fan level". Configure the necessary fan level in the parameter "Fan level". This setting cannot be selected in the fan coil systems "2-pipe heating" and "2-pipe heating/cooling via change-over object".
At the end of the disabling the cooling valve is opened. The fan is switched to the parameterised level. In fan coil systems with the combined "heating/cooling" mode of operation the opening of the cooling valve causes the heating valve to close automatically, if it is open at the instant the enabling is opened. This state remains until a new command value and if necessary a mode of operation change-over is received, or until activation of a function with a lower priority (e.g. manual fan control).

- Set the parameter to "Specified mode of operation with fan level". Configure the necessary fan level in the parameter "Fan level". This setting can only be selected in the fan coil system "2-pipe heating/cooling via change-over object".

The common valve for heating/cooling is opened at the end of the disabling, if it is not open already. The fan is switched to the parameterised level.
If the mode of operation is not known at the instant of enabling, i.e. no telegram has been received yet via the change-over object, then the channel concerned remains completely switched off until a valid mode of operation is received.
- Set the parameter to "tracked state".

At the end of the disabling the combination of valve position and fan level is set that corresponds to the command value last received during the disabling. If no command value has been received during the disabling, then the channel state last set at the beginning of the disabling is retained until a new command value is received.
For fan coil systems with mode of operation change-over via the change-over object it is also necessary to specify a valid mode of operation.
- ⓘ The disabling function is always deactivated after bus or mains voltage return or after ETS programming. In this case the configured "behaviour at the end of the disabling function" is not executed!
- ⓘ When a disabling function is deactivated, a switch-on level and also switch-on and switch-off delays of a channel are taken into account for all settings, if so set in the ETS.
- ⓘ At the end of a disabling function the monitoring time for cyclical monitoring is restarted. In this case any fault message previously transmitted is retracted by transmitting the inverted telegram value for the fault message.
- ⓘ A level limitation has no effect on the corresponding fan coil channel during a disabling function. A level limitation is only taken into account again at the end of a disabling function, if the limitation was activated via a bus telegram before or during the disabling. Thus the fan level parameterised in the ETS is limited if necessary at the end of the disabling function!

4.2.4.4 Priorities

Priorities

The fan coil actuator distinguishes between various functions that can have an effect on the a fan coil channel and thus on its outputs. In order to prevent conflicting states, each available function has a certain priority. The function with the higher priority overrides the one with the lower priority or influences it.

Taking into account all additional functions, the following priorities are defined....

- 1st priority: switch-on level and dwell time for switch-on level (highest priority)
- 2nd priority: dwell time for level change-over / pause "OFF" for level change-over
- 3rd priority: manual control locally on the actuator
- 4th priority: behaviour in case of mains or bus voltage return or bus voltage failure
- 5th priority: switch-on or switch-off delay of the fan levels
- 6th priority: disabling function
- 7th priority: fan level limitation
- 8th priority: valve or fan protection
- 9th priority: manual fan control
- 10th priority: normal operation (control via the bus using command values, etc.) / behaviour after the monitoring time for the command values has elapsed.

i The "Dwell time for level change-over" (fan control with level principle) has no effect in manual fan control.

i The switch-on or switch-off delay for the fan levels has no effect in the event of fan protection.

4.2.4.5 Summary of the output assignments

Summary of the output assignments

output assignment 1 fan coil channel									
number of fan levels	output assignment								fan coil system
	O1	O2	O3	O4	O5	O6	O7	O8	
6 levels	heating	unused	level 1	level 2	level 3	level 4	level 5	level 6	2-pipe only heating
5 levels	heating	unused	level 1	level 2	level 3	level 4	level 5	switching	
4 levels	heating	unused	level 1	level 2	level 3	level 4	switching	switching	
3 levels	heating	unused	level 1	level 2	level 3	switching	switching	switching	
2 levels	heating	unused	level 1	level 2	switching	switching	switching	switching	
1 level	heating	unused	level 1	switching	switching	switching	switching	switching	
6 levels	cooling	unused	level 1	level 2	level 3	level 4	level 5	level 6	2-pipe only cooling
5 levels	cooling	unused	level 1	level 2	level 3	level 4	level 5	switching	
4 levels	cooling	unused	level 1	level 2	level 3	level 4	switching	switching	
3 levels	cooling	unused	level 1	level 2	level 3	switching	switching	switching	
2 levels	cooling	unused	level 1	level 2	switching	switching	switching	switching	
1 level	cooling	unused	level 1	switching	switching	switching	switching	switching	
6 levels	heating / cooling	unused	level 1	level 2	level 3	level 4	level 5	level 6	2-pipe heating / cooling
5 levels	heating / cooling	unused	level 1	level 2	level 3	level 4	level 5	switching	
4 levels	heating / cooling	unused	level 1	level 2	level 3	level 4	switching	switching	
3 levels	heating / cooling	unused	level 1	level 2	level 3	switching	switching	switching	
2 levels	heating / cooling	unused	level 1	level 2	switching	switching	switching	switching	
1 level	heating / cooling	unused	level 1	switching	switching	switching	switching	switching	
6 levels	cooling	heating	level 1	level 2	level 3	level 4	Stufe 5	Stufe 6	4-pipe heating / cooling
5 levels	cooling	heating	level 1	level 2	level 3	level 4	Stufe 5	switching	
4 levels	cooling	heating	level 1	level 2	level 3	level 4	switching	switching	
3 levels	cooling	heating	level 1	level 2	level 3	switching	switching	switching	
2 levels	cooling	heating	level 1	level 2	switching	switching	switching	switching	
1 level	cooling	heating	level 1	switching	switching	switching	switching	switching	

Figure 33: Output assignments for one fan coil channel

output assignment 2 fan coil channels									
number of fan levels	output assignment								fan coil system
	channel 1				channel 2				
	O1	O2	O3	O4	O5	O6	O7	O8	
3 levels	heating	level 1	level 2	level 3					2-pipe only heating
2 levels	heating	level 1	level 2	switching					
1 level	heating	level 1	switching	switching					
3 levels					heating	level 1	level 2	level 3	
2 levels					heating	level 1	level 2	switching	
1 level					heating	level 1	switching	switching	
3 levels	cooling	level 1	level 2	level 3					2-pipe only cooling
2 levels	cooling	level 1	level 2	switching					
1 level	cooling	level 1	switching	switching					
3 levels					cooling	level 1	level 2	level 3	
2 levels					cooling	level 1	level 2	switching	
1 level					cooling	level 1	switching	switching	
3 levels	heating / cooling	level 1	level 2	level 3					2-pipe heating / cooling
2 levels	heating / cooling	level 1	level 2	switching					
1 level	heating / cooling	level 1	switching	switching					
3 levels					heating / cooling	level 1	level 2	level 3	
2 levels					heating / cooling	level 1	level 2	switching	
1 level					heating / cooling	level 1	switching	switching	

Figure 34: Output assignments for two fan coil channels

4.2.4.6 State as supplied

State as supplied

In the state of the actuator as supplied the device behaves passively, i.e. no telegrams are transmitted to the bus. The outputs can, however, be operated by manual control on the device, if the mains voltage is on. In manual control there is no feedback to the bus. Other functions of the actuator are deactivated.

The device can be programmed and put into operation via the ETS. The physical address is preset to 15.15.255

Moreover the device has been configured at the factory with the following characteristics...

- Number of fan coil channels: 1
- Fan coil system: 4-pipe heating / cooling
- Number of fan levels: 6
- Control of the fan levels: change-over principle (only one output switches)
- Behaviour in case of bus voltage failure: switch off
- Behaviour in case of bus or mains voltage return: switch off
- Behaviour after ETS programming: switch off
- Switch-on level: none
- Switch-on delay / switch-off delay: none
- Valve protection: no
- Fan protection: no

4.2.5 Parameter

Description	Values	Comment
<p>□ General</p> <p>Number of fan coil channels</p>	<p>1 fan coil channel (maximum of 6 fan levels)</p> <p>2 fan coil channels (maximum of 3 fan levels each)</p>	<p>Depending on the number set, the relay outputs of the actuator are either in only one channel, or divided into two channels.</p> <p>All valve and fan level outputs of the actuator are assigned to just one fan coil channel. A fan coil unit can be connected to the device. In this configuration a maximum of 6 fan levels can be set.</p> <p>The valve and fan level outputs of the actuator are combined into two pairs, each of which is assigned to one fan coil channel. It is thus possible to connect two fan coil units to the fan coil actuator. In this configuration a maximum of 3 fan levels can be set per channel.</p> <p>i This parameter should be set at the beginning of the device configuration, because all further channel-oriented parameters are dependent on this setting. If the parameter is only changed during the course of a device configuration, the assignments of group addresses to objects could be lost or parameter settings could be reset!</p>
Type of fan coil system	<p>2-pipe only heating</p> <p>2-pipe only cooling</p> <p>2-pipe heating/cooling via change-over object</p>	<p>The fan coil system determines in what modes of operation (heating or cooling) the actuator works, how change-over takes place in the mixed operating mode "heating/cooling", and also defines whether a 2-pipe or a 4-pipe system is being controlled.</p> <p>The fan coil channel concerned can only heat. The heating energy is supplied to the connected fan coil unit via a 2-pipe system (= 1 valve for heating).</p> <p>The fan coil channel concerned can only cool. The cooling energy is supplied to the connected fan coil unit via a 2-pipe system. (= 1 valve for cooling).</p> <p>The fan coil channel concerned can either heat or cool. Which of these modes of operation is active is controlled by a 1-bit switchover object. The heating or cooling energy is supplied to the connected fan coil unit via a combined 2-pipe system (= 1 valve for heating and cooling).</p>

	4-pipe heating/cooling via change-over object	The fan coil channel concerned can either heat or cool. Which of these modes of operation is active is controlled by a 1-bit switchover object. The heating or cooling energy is supplied to the connected fan coil unit via a divided 4-pipe system (= 1 valve for heating and 1 valve for cooling).
	4-pipe heating/cooling via command value specification	The fan coil channel concerned can either heat or cool. Which of these modes of operation is active is determined by the last command value received (not equal to "0"). The heating or cooling energy is supplied to the connected fan coil unit via a divided 4-pipe system (= 1 valve for heating and 1 valve for cooling).
Type of fan coil system, channel 1	2-pipe only heating	The fan coil system determines in what modes of operation (heating or cooling) the first channel of the actuator works, how switchover takes place in the mixed operating mode "heating/cooling", and also defines whether a 2-pipe or a 4-pipe system is being controlled.
	2-pipe only cooling	The fan coil channel concerned can only heat. The heating energy is supplied to the connected fan coil unit via a 2-pipe system (= 1 valve for heating).
	2-pipe heating/cooling via change-over object	The fan coil channel concerned can only cool. The cooling energy is supplied to the connected fan coil unit via a 2-pipe system. (= 1 valve for cooling).
Type of fan coil system, channel 2	2-pipe only heating	The fan coil channel concerned can either heat or cool. Which of these modes of operation is active is controlled by a 1-bit switchover object. The heating or cooling energy is supplied to the connected fan coil unit via a combined 2-pipe system (= 1 valve for heating and cooling).
		<p>i This parameter is only visible in configurations with two fan coil channels!</p>
		The fan coil system determines in what modes of operation (heating or cooling) the second channel of the actuator works, how switchover takes place in the mixed operating mode "heating/cooling", and also defines whether a 2-pipe or a 4-pipe system is being controlled.

			<p>The fan coil channel concerned can only heat. The heating energy is supplied to the connected fan coil unit via a 2-pipe system (= 1 valve for heating).</p>
	2-pipe only cooling		<p>The fan coil channel concerned can only cool. The cooling energy is supplied to the connected fan coil unit via a 2-pipe system. (= 1 valve for cooling).</p>
	2-pipe heating/cooling via change-over object		<p>The fan coil channel concerned can either heat or cool. Which of these modes of operation is active is controlled by a 1-bit switchover object. The heating or cooling energy is supplied to the connected fan coil unit via a combined 2-pipe system (= 1 valve for heating and cooling).</p> <p>i This parameter is only visible in configurations with two fan coil channels!</p>
<p>☐ Times</p>			
Delay after bus voltage return Minutes (0...59)	0...59		<p>In order to reduce the telegram traffic on the bus line after the bus voltage is switched on (bus reset), after connection of the device to the bus line or after ETS programming it is possible to delay all of the actively transmitting feedback or status messages of the actuator. This parameter defines a delay time independent of the channel for this case. Only after the time parameterised here elapses are assigned feedback telegrams and status telegrams for initialisation transmitted to the bus.</p> <p>Setting the delay time minutes.</p>
Seconds (0...59)	0...17...59		<p>Setting the delay time seconds.</p> <p>i The setting "0" for the hours and minutes deactivates the delay time completely.</p>
Time for cycl. transmission of the feedback telegrams Hours (0...23)	0...23		<p>The different actively transmitting feedback telegrams of the actuator can, depending on the parameterisation, also transmit their state cyclically to the bus. The parameter "Time for cycl. transmission of the feedback" defines the cycle time independent of the channel.</p> <p>Sets the cycle time hours.</p>
Minutes (0...59)	0...2...59		<p>Sets the cycle time minutes.</p>

i The setting "0" for the hours and minutes deactivates the cyclical transmission for all channels.

□ Channel x - general (x = 1 or 2)

Behaviour after ETS programming

switch off all valve & fan outputs

After any programming via the ETS, all valve and fan level outputs of the fan coil actuator are always opened (OFF state). The relays of the simple switching outputs, if present, also open. The behaviour after ETS programming is thus specified as a fixed value, and cannot be adjusted.

Behaviour in case of bus voltage failure:

switch off all valve & fan outputs

In the event of a bus voltage failure, all valve and fan outputs of the actuator are switched off. Switch-off delays set for fan levels are not taken into consideration here. If the fan levels are controlled using the level principle, switching-off is performed in stages taking into account the dwell time in the level change-over.

no change in the valve & fan states

In the event of a bus failure, all valve and fan relay states remain unchanged. So long as the actuator remains supplied with mains voltage in this state, dwell times or pause times for a previously executed level change-over or switch-on level will be processed (higher priority), after which the intended "target state" of the fan will be set.

Behaviour after bus or mains voltage return

switch off all valve & fan outputs

In case of bus or mains voltage return, all valve and fan outputs of the actuator are switched off. If the fan levels are controlled using the level principle, switching-off is performed in stages taking into account the dwell time in the level change-over. If a switch-off delay has been configured for the fan, then it is taken into account after the cooling valve is switched off. Any switch-off delay previously started and still active is, however, aborted in case of bus or mains return, and then immediately set to the intended "OFF" state. Disabling functions or fan level limitations are deactivated. The manual fan controls are deactivated, so long as their parameterisation does not call for any activation (parameter "Activate manual fan control after bus or mains voltage failure? = no").

Valve & fan states as before bus/mains failure

In the event of bus or mains voltage return the application data saved before bus or mains voltage failure are restored, and the states of the valve and fan level outputs are tracked. In case of restoration of the states of the fan level outputs, switch-on delays,

Read request to "Heating/cooling change-over" object?	Yes	switch-on levels incl. dwell times and dwell/pause times for the level change-over are taken into account. The tracked relay states are never set until the mains voltage is also present.
	No	When the setting is "Yes", immediately after its initialisation the fan coil actuator transmits a read request (ValueRead) to the group address of the object "Heating/cooling change-over". The corresponding value feedback, e.g. of a room thermostat, then specifies a valid mode of operation to the actuator.
		The setting "No" deactivates the read request. In this case the fan coil actuator waits after a reset for a new telegram for mode of operation change-over.
		<p>i This parameter is only visible if the "Type of fan coil system" is configured to "<u>... via change-over object</u>".</p>
Delay time for read request seconds (0...59)	0... 30 ...59	<p>After a device reset the fan coil actuator waits in accordance with the specified "Delay time for read request" until it transmits the read request via the object "Heating / cooling change-over". With the setting "0 s" the actuator does not wait and transmits the read telegram to the bus immediately after its own initialisation. This initialisation time of approx. 5 s is always in effect (even when the delay for read request is deactivated), and thus adds itself to the time set in the ETS.</p> <p>Setting the delay time seconds.</p> <p>i This parameter is only visible if the parameter "Read request to object 'Heating / cooling change-over'?" is set to "Yes".</p> <p>i The "Delay after bus voltage return" set in the ETS has no effect on the read request.</p>
Valve protection	<p>deactivated</p> <p>cyclically 24h after the last valve adjustment</p>	<p>The fan coil actuator can protect the valves for heating and cooling connected for each channel against sticking. The anti-sticking protection is generally necessary to prevent a valve defect if the valve drives are not moved for a prolonged time.</p> <p>The valve protection is deactivated.</p> <p>The valve protection is enabled. The 24-hour meter is started automatically after initialisation of the actuator. If a valve is</p>

Fan protection	<p>deactivated cyclically 24h after the last valve adjustment</p>	<p>not actuated for a period of 24 hours, then the actuator opens the corresponding valve for a period of 5 minutes. This process is repeated cyclically every 24 hours, so long as in the meantime no valve activation is performed via command values, via a disabling function, or via manual control.</p> <p>The fan coil actuator can protect the connected fan motors against sticking, and the fan blades and the heat exchanger of the fan coil against dust. This protection function is generally necessary to prevent a fan defect if the fan has not been moved for a prolonged time.</p>
<p><input type="checkbox"/> Cx - fan configuration (x = 1 or 2) Number of fan levels 1...6</p>	<p>The fan protection is deactivated.</p>	<p>The fan protection is deactivated.</p> <p>The communication object "Enable fan protection" in the ETS is enabled. The 24-hour meter is started automatically after initialisation of the actuator. If a fan is not activated for a period of 24 hours, then the actuator switches the corresponding fan to the the highest permissible fan level for a period of 5 minutes, so long as enabling was previously granted via the communication object. The fan protection is repeated cyclically every 24 hours, so long as in the meantime no fan activation is performed via command values, via a disabling function, or via manual control.</p>
Number of fan levels 1...3		<p>The maximum number of usable fan levels depends on this parameter. In the configuration with only one fan coil channel a maximum of 6 fan levels can be used. Fan level outputs of a fan coil channel which are not used can optionally be used as switching outputs with a simple switching function. The ETS defines these switching outputs automatically.</p> <p>With this setting the required fan levels and the associated parameters are defined in the ETS.</p> <p>i This parameter is only visible in a configuration with one fan coil channel.</p>
		<p>The maximum number of usable fan levels depends on this parameter. In the configuration with two fan coil channels a maximum of 3 fan levels can be used. Fan level outputs of a fan coil channel which are not used can optionally be used as switching outputs with a simple switching function. The ETS defines</p>

Controlling the fan levels

these switching outputs automatically. With this setting the required fan levels and the associated parameters are defined in the ETS.

i This parameter is only visible in a configuration with two fan coil channels.

In standard commercially available fan coils, there is generally a distinction made between two different ways to control the fan levels. Which of these two principles has to be used should be obtained from the technical documentation of the connected fan coil.

only one fan output switches (change-over principle)

As soon as the fan is running, there is always only one fan level output switched on. All other non-active levels are switched off.

Fan outputs switch hierarchically (level principle)

When the fan is switched on, the fan level outputs switch one after another (hierarchically). All fan levels lower than the active fan level remain switched on, higher ones switched off.

i When only one fan level is used, this parameter is always set to "only one fan output switches (change-over principle)".

Command value lower limit for fan level 1 (1...100 %)

1...**5**...100

So that the fan coil actuator can evaluate which of the up to 6 fan levels of a fan coil channel has to be set to active, each fan level has a lower limit for the command value assigned to it. Assignment is carried out in the ETS by parameterising a command value (1...100 %) for each fan level. As soon as a command value reaches or crosses a lower limit, the actuator activates the corresponding fan level.

Setting of the lower limit for fan level 1.

Command value lower limit for fan level 2 (1...100 %)

1...**20**...100

Setting of the lower limit for fan level 2.

i This parameter is only visible if fan level 2 is present.

Command value lower limit for fan level 3 (1...100 %)

1...**40**...100

Setting of the lower limit for fan level 3.

i This parameter is only visible if fan level 3 is present.

Command value lower limit for fan level 4 (1...100 %)

1...**60**...100

Setting of the lower limit for fan level 4.

i This parameter is only visible if fan level 4 is present.

Command value lower limit for fan level 5 (1...100 %)

1...**80**...100

Setting of the lower limit for fan level 5.

i This parameter is only visible if fan level 5 is present.

<p>Command value lower limit for fan level 6 (1...100 %)</p>	<p>1...95...100</p>	<p>Setting of the lower limit for fan level 6.</p> <ul style="list-style-type: none"> i This parameter is only visible if fan level 6 is present. i The following applies: lower limit for level 1 < lower limit for level 2 < ... < lower limit for level 6. The lower levels for the various fan levels set in the ETS may not be set to identical values, and also may not overlap! Otherwise the fan levels can no longer be controlled unambiguously according to their sequence! The ETS does not catch such parameterisation errors automatically!
<p>Hysteresis for level change-over (0...20 %; 0 = hysteresis deactivated)</p>	<p>0...10...20</p>	<p>A fan level is only deactivated when the active command value reaches or undershoots the lower limit of the level less the hysteresis derived from the lower limit. The hysteresis is set in the ETS only once per fan coil channel, and is derived relatively from each command value lower limit. With the setting "0 %" the hysteresis is inactive, meaning that a fan level is deactivated immediately when its command value lower limit is undershot.</p>
<p><input type="checkbox"/> Cx - fan behaviour (x = 1 or 2)</p>		
<p>Fan level when the fan is switched on</p>	<p>as specified by command value lower limits</p>	<p>When the fan is switched on, i.e. if it was switched off before and was at a standstill, the fan can be switched on temporarily to a defined switch-on level. This switch-on level can be any of the available fan levels.</p> <p>The switch-on level is deactivated. The fan switches on to the active fan level. In normal operation the active fan level is determined based on the command value telegrams received and the specified level weight (command value lower limits).</p>
	<p>independent switch-on level (time-controlled)</p>	<p>The switch-on level is activated. The fan switches on to the switch-on level and remains in this level until the dwell time has elapsed. Only after that does it switch to the specified active fan level.</p>
<p>Switch on to switch-on level</p>	<p>1...2...6* *: The selection is limited by the configured number of fan levels.</p>	<p>This parameter defines the level to which the fan is to be switched on.</p> <ul style="list-style-type: none"> i This parameter is only visible when the parameter "Fan level when the fan is switched on" is set to "independent switch-on level (time-controlled)".

<p>Dwell time for switch-on level 0...15...59</p>	<p>i If only one fan level is configured, the fan always switches on to fan level 1.</p> <p>This parameter defines the dwell time for the switch-on level</p> <p>Sets the dwell time seconds.</p> <p>i This parameter is only visible when the parameter "Fan level when the fan is switched on" is set to "independent switch-on level (time-controlled)".</p>
<p>Fan switch-on delay for heating Minutes (0...59) 0...59</p>	<p>In order to prevent cold air from flowing out at the beginning of a heating process, a switch-on delay can be configured for the fan. Only after the end of the switch-on delay does the fan switch on and blow pre-heated air into the room.</p> <p>Sets the switch-on delay minutes.</p>
<p>Seconds (0...59) 0...30...59</p>	<p>Sets the switch-on delay seconds.</p> <p>i The setting "0" for the minutes and seconds deactivates the switch-on delay completely.</p>
<p>Fan switch-off delay for cooling Minutes (0...59) 0...59</p>	<p>In order to prevent cold air from flowing out at the beginning of a heating process, a switch-on delay can be configured for the fan. Only after the end of the switch-on delay does the fan switch on and blow pre-heated air into the room.</p> <p>Sets the switch-off delay minutes.</p>
<p>Seconds (0...59) 0...30...59</p>	<p>Sets the switch-off delay seconds.</p> <p>i The setting "0" for the minutes and seconds deactivates the switch-off delay completely.</p>
<p>Pause "OFF" for level change-over Seconds (0...2) 0...1...2</p>	<p>If the active fan level is changed, the fan coil actuator first switches the previously switched-on fan level off ("OFF" state), and only after that switches the other output on.</p> <p>In this case the parameterised "Pause 'OFF' for level change-over" is maintained. This means that when the fan level is changed the fan coil actuator remains in the "OFF" state for the parameterised period, and switches directly to the specified level only after the time has elapsed.</p> <p>Sets the pause time seconds.</p>
<p>1...9</p>	<p>Sets the pause time milliseconds.</p>

<p>Milliseconds (1...9 * 100 ms)</p>		<p>i The parameters for a pause time are only visible if the "Control of the fan levels" is configured to "only one fan output switches (change-over principle)".</p>
<p>Dwell time for level change-over Seconds (0...2)</p>	<p>0...1...2</p>	<p>When the fan level is changed through more than one level, the change is not carried out abruptly, but rather always via brief activation of the intervening level(s). In this case the parameterised "Dwell time for level change-over" is maintained. This means that the fan coil actuator remains in each intervening level, and is only changed over to the next after the next following level after the time has elapsed.</p> <p>Sets the dwell time seconds.</p>
<p>Milliseconds (1...9 * 100 ms)</p>	<p>1...9</p>	<p>Sets the dwell time milliseconds.</p> <p>i The parameters for the dwell time are only visible if the "Control of the fan levels" is configured to "Fan outputs switch hierarchically (level principle)".</p>
<p>Level limitation via object</p>	<p>disabled enabled</p>	<p>To reduce the fan noise of a fan coil, the fan level limitation can be activated. The limitation is switched on and off via a 1-bit communication object via the bus, and thus activated in accordance with requirements. In order for it to be used, the level limitation must be enabled here.</p> <p>The fan limitation is deactivated.</p> <p>The communication object "Level limitation" becomes visible in the ETS. As soon as the level limitation is activated via the object, the fan coil actuator limits the fan level and thus the fan speed and consequently the fan noise for fan level control via the bus by means of regular command value telegrams, for manual fan control, for fan level specification of the cyclical monitoring, and for fan protection. In case of the setting "Switch off fan" for the level limitation, the fan and also any valves that are switched on are switched off as soon as the limitation is activated.</p>
<p>Fan level with limitation</p>	<p>Switch off fan, 1...6 *</p> <p>*: The selection is limited by the configured number of fan levels.</p>	<p>This parameter can be used to configure the fan level to which the fan is limited when a fan limitation is active.</p> <p>In case of the setting "Switch off fan" for the level limitation, the fan and also any</p>

valves that are switched on are switched off as soon as the limitation is activated.

i This parameter is only visible if the parameter "Level limitation via object" is set to "enabled".

Cx - fan feedback (x = 1 or 2)

Feedback for the active fan level

The fan coil actuator can send feedback for the specific fan level that is active to the bus separately for each channel. In this manner the state of the fan coil can be transmitted to the bus at any time and displayed in a visualisation or evaluated further in other bus devices, for example.

A distinction is made between feedback objects that function as actively transmitting signalling objects or as passive status objects.

No

The fan level feedback is deactivated.

yes, active signalling object

The feedback is enabled. As soon as the actuator updates a feedback object, a telegram is also actively transmitted to the bus. In the ETS, the "Transmission" flags are automatically set for the feedback objects.

yes, passive status object

The feedback is enabled. The actuator updates only the feedback objects internally, and does not transmit any telegram. The object value can be read out via the bus at any time (ValueRead), as a result of which the actuator then transmits a response telegram (ValueResponse). In the ETS, the "Read" flags are automatically set for the feedback objects.

Type of feedback

The feedback for the active fan level takes place depending on the data format set here either via individual 1-bit communication objects separately for each fan level or alternatively via only one 1-byte value object in common for all fan levels of a channel.

Fan levels via value

The data format for the fan level feedback is defined as 1 byte. Here the feedback object returns the currently valid fan level as a numeric value (in acc. with KNX DPT 5.010). The numeric value corresponds directly to the active fan level (0...max. 6; 0 = no level output switched on, fan OFF). Only one communication object is visible in common for all fan levels of a channel. When the fan level is changed, the actuator always updates and transmits the current object value.

Fan levels individually

Feedback for "Fan coil active"	disabled	<p>The data format for the fan level feedback is defined as 1 bit. Here the feedback returns switching states directly that identify with regard to a fan level whether the corresponding fan output (acc. to KNX DTP 1.001) is switched on or off. Thus there exist (1...max. 6) separate objects for each fan level. Therefore all objects have the state "OFF" when the fan is stopped, i.e. when it is switched off. When the fan level is changed, the actuator updates and transmits only the object values that change.</p>
	enabled	<p>By means of the feedback "Fan coil active" the actuator can indicate separately for each fan coil channel whether the fan and/or a valve of the corresponding channel is switched on. This feedback takes place via the 1-bit communication object "Feedback for fan coil active". This object is actively transmitting: As soon as the actuator of any of the outputs of a channel is switched on, a "1" telegram is transmitted to the bus. Consequently a "0" telegram is transmitted immediately as soon as all outputs of the channel are switched off.</p>
Time delay for feedback telegram(s) ... after bus voltage return?	Yes (delay time under "Times"!)	<p>The feedback "Fan coil active" is deactivated.</p>
	No	<p>The feedback function is enabled and the feedback object "Feedback for fan coil active" is visible.</p>
		<p>Whether the feedback telegrams "Active fan level" and "Fan coil active" are transmitted with a time delay after initialisation can be configured here in common for both feedback telegrams. The delay time itself is configured independent of the channel on the parameter page "Times".</p>
		<p>After the bus voltage supply is switched on or after ETS programming the feedback telegrams for the active fan level and "Fan coil active" are transmitted with a time delay.</p>
		<p>After the bus voltage supply is switched on or after ETS programming the feedback telegrams for the active fan level and "Fan coil active" are transmitted to the bus immediately after initialisation of the actuator.</p>
		<p>i The name of this parameter depend on which feedback telegrams ("active fan level" and/or "Fan coil active") have been enabled.</p>

Cyclical transmission for feedback telegram(s) ... ?

- i** This parameter is only visible with enabled fan level feedback as an active signalling object and/or with enabled "Fan coil active" feedback.

Whether the feedback telegrams "Active fan level" and "Fan coil active" are transmitted cyclically can be configured here in common for both feedback telegrams.

The feedback telegram is transmitted to the bus cyclically and when there is a change of state. The cycle time is parameterised under "Times" generally for all feedback telegrams.

Yes (transmit cyclically and in the event of an update)

The current object values of the feedback telegrams "Active fan level" and "Fan coil active" are also transmitted to the bus cyclically in addition to telegram transmission in case of an update or request. At the end of the cycle time all object values of a channel are always sent one immediately after the other. The telegram sequence is undefined.

No (transmit only in the event of an update)

Cyclical transmission is deactivated. The current object values of the feedback telegrams "Active fan level" and "Fan coil active" are transmitted to the bus only in case of an update or request. This means that when there is an update a telegram is only transmitted for feedback objects whose value has changed.

- i** The name of this parameter depend on which feedback telegrams ("active fan level" and/or "Fan coil active") have been enabled.

- i** This parameter is only visible with enabled fan level feedback as an active signalling object and/or with enabled "Fan coil active" feedback.

Request object for feedback telegram(s) ...

Transmission of the feedback telegrams of a channel can be initiated via the bus at any time. For this purpose each fan coil channel has the 1-bit communication object "Request feedback". As soon as any switching telegram ("0" or "1") is received via this object, the actuator immediately initiates transmission of the feedback telegrams "Active fan level" and "Fan coil active".

disabled

The feedback request is deactivated, the object is hidden in the ETS. The current object values of the feedback telegrams "Active fan level" and "Fan coil active"

		<p>are transmitted to the bus only in case of an update or via cyclical transmission.</p>
	<p>enabled</p>	<p>The request object is enabled. In case of a request all actively transmitting feedback object values of a channel are transmitted one immediately after the other. The telegram sequence is undefined.</p>
		<p>i The name of this parameter depend on which feedback telegrams ("active fan level" and/or "Fan coil active") have been enabled.</p>
		<p>i This parameter is only visible with enabled fan level feedback as an active signalling object and/or with enabled "Fan coil active" feedback.</p>
<p><input type="checkbox"/> Cx - manual fan control (x = 1 or 2)</p>		
<p>Manual fan control</p>		<p>The manual fan control makes it possible to control the fan in the fan coil independent of the command value specification of a room thermostat. The manual fan control function can be enabled in the ETS separately for each fan coil channel.</p>
	<p>disabled</p>	<p>The manual fan control is deactivated.</p>
	<p>enabled</p>	<p>The manual fan control is enabled for the corresponding channel. Additional parameters and objects become visible.</p>
<p>Activation of manual fan control</p>		<p>The fan can only be controlled manually if the function of the manual fan control has been activated in the fan coil actuator via the bus. The manual fan level control can be activated and deactivated here in two different ways.</p>
	<p>via object "Man. fan lev. active/inactive"</p>	<p>The communication object "Manual fan control active/inactive" is visible in the ETS. The manual fan control is activated by this object via an "ON" telegram and deactivated via an "OFF" telegram.</p>
	<p>via object "Man. fan lev. specification"</p>	<p>Manual fan control is activated as soon as any telegram is received via the object "Manual fan control specification", independently of the data format that is set. The telegram is also evaluated immediately as a control specification, meaning that the fan is switched to a fan level according to the specification. To deactivate manual fan control, the 1-bit object "Deactivate manual fan control" must have an "OFF" telegram written to it. An "ON" telegram to this object shows no reaction.</p>

<p>Fan level change-over in case of manual specification via</p>	<p>Value object (1 byte)</p>	<p>i This parameter is only visible if the manual fan control is enabled.</p>	<p>When manual fan control is activated, the fan of the fan coil can be controlled directly via the object "Manual fan control specification". The data format for this object can be configured to 1 bit or alternatively to 1 byte, thus allowing control of the fan levels either via a switching direction specification or via a value specification.</p>
<p>Manual fan control only with active heating / cooling</p>	<p>Switching direction object (1 bit)</p>	<p>i This parameter is only visible if the manual fan control is enabled.</p>	<p>The data format of the specification object is set to 1 byte value specification (KNX DP type 5.010). At the time of activation or during manual fan control the fan level corresponding to the value of the last specification telegram is set. If the value of the specification object exceeds the maximum number of fan levels or, in case of active level limitation, it is larger than the limitation level, then the maximum possible or limited level value is set. An object value of "0" switches off both the fan and the valves, if they were last switched on.</p>
<p>No</p>	<p>The data format of the specification object is set to 1 bit switching direction (KNX DP type 1.007), and corresponds for example to the format of a push-button that transmits simple switching telegrams to the bus when a rockers switch is actuated (button 1 ON, button 2 OFF). At the time of activation or during manual fan control the last fan level that was set is increased gradually one level at a time (object value "1") or decreased (object value "0"). The fan level can be increased until the maximum number of fan levels or the limitation level is reached. It can be decreased all the way to switching-off of the fan.</p>	<p>The fan coil actuator makes a distinction between two functional principles of the manual fan control, which can be configured here as alternatives to each other.</p>	<p>Manual fan control can be performed independently of heating or cooling operation, i.e. even when the valves are closed. Changes in the command value of a room thermostat have no effect on the fan level, so long as the manual fan control is activated.</p>

<p>Yes</p>	<p>The manual fan control can only be performed if the valves for heating or cooling are opened, i.e. the command value of the active mode of operation is greater than 0 % and a valid mode of operation (heating / cooling) has been specified. As long as the active command value is 0 % or no mode of operation has been specified yet, the fan can never be switched on using manual control.</p> <p>i This parameter is only visible if the manual fan control is enabled.</p>
<p>Activate manual fan control after bus or mains vltg. return ?</p>	<p>It is possible to activate manual fan control automatically after return of bus or mains voltage or after ETS programming. Automatic activation of the manual fan control is useful, for example, if a channel of the actuator is primarily used only for multiple-level ventilation, and the control is to be activated immediately after a device reset.</p>
<p>No</p>	<p>Manual fan control is not activated automatically after return of bus or main voltage. The "behaviour after bus or mains voltage return" is performed which was configured separately for each fan coil channel on the parameter page "Channel x - general". After ETS programming, manual fan control is always deactivated in this configuration.</p>
<p>Yes</p>	<p>The manual fan control is activated under forced control after return of bus or mains voltage or after ETS programming. For the fan coil channel concerned, the "behaviour after bus or mains voltage return" which was configured on the parameter page "Channel x - general" is <u>not</u> performed.</p> <p>i This parameter is only visible if the manual fan control is enabled.</p>
<p><input type="checkbox"/> Cx - cyclical monitoring (x = 1 or 2)</p> <p>Cyclical monitoring of the command values</p>	<p>The fan coil actuator makes it possible to monitor the active command value for each fan coil channel. This monitoring checks whether command value telegrams have been received by the fan coil actuator within a time interval (monitoring time) that can be defined in the ETS. If there are no telegrams during the monitoring time, then the actuator can set the valve and fan outputs to a state parameterised in the ETS.</p>

	deactivated	The cyclical monitoring is completely disabled. No telegram monitoring of the command value objects is performed.
	enabled	Cyclical monitoring is enabled and the parameters for the function are visible in the ETS. When monitoring is enabled, in fault-free operation the command value object active depending on the mode of operation must have telegrams transmitted to it cyclically.
Monitoring time Hours (0...23)	0...23	This parameter defines the monitoring time for cyclical monitoring.
		Sets the monitoring time hours.
Minutes (1...59)	1... 30 ...59	Sets the monitoring time minutes.
		i The parameters for the monitoring time are only visible if cyclical monitoring is enabled.
Reaction at the end of the monitoring time		If the fan coil actuator does not receive any command value telegram of the active mode of operation within the time interval of the monitoring time, then the fan coil channel immediately enters the fault state configured here, provided that no function with a higher priority is activated at that instant. The possible parameter settings are dependent on the configured fan coil system.
	no reaction	No special fault state is set. The current valve position and fan level is adopted with no changes after the end of the monitoring time.
	Switch off all valve & fan outputs	For the fault state all valves are closed and the fan is switched off.
	Heating with fan level	In the fault state the heating valve is opened. The fan is switched to the parameterised level. This parameter setting cannot be selected with the fan coil system "2-pipe heating/cooling".
	Cooling with fan level	In the fault state the cooling valve is opened. The fan is switched to the parameterised level. This parameter setting cannot be selected with the fan coil system "2-pipe heating/cooling".
	specified mode of operation with fan level	The common valve for heating/cooling is opened in the fault state, if it is not open already. The fan is switched to the parameterised level. This parameter setting can only be selected with the fan coil system "2-pipe heating/cooling".
		i This parameter is only visible if cyclical monitoring is enabled.
Fan level	1...6 *	

<p>*: The selection is limited by the configured number of fan levels.</p> <p>Fault message at the end of the monitoring time</p>	<p>*: The selection is limited by the configured number of fan levels.</p>	<p>This configures the fan level that should be set in the event of a fault in active heating or cooling operation.</p>
		<p>i This parameter is only visible if the parameter "Reaction at the end of the monitoring time" is configured with the following settings: "Heating with fan level", "Cooling with fan level" or "Specified mode of operation with fan level".</p> <p>i This parameter is only visible if cyclical monitoring is enabled.</p>
	<p>disabled</p>	<p>If in the course of cyclical monitoring no command value telegram is received before the end of the monitoring time, the fan coil actuator immediately assumes the valve and fan level state (fault state) configured in the ETS. Here the actuator can transmit a 1-bit fault message to the bus, which can for example be evaluated by means of other bus devices for further processing.</p> <p>The fault message is completely deactivated. In the event of a command value fault, if necessary only the "Reaction at the end of the monitoring time" parameterised in the ETS is executed.</p>
	<p>enabled</p>	<p>The fault message is enabled and the communication object "Fault message for cyclical monitoring" becomes visible in the ETS. As soon as the monitoring time ends without a command value telegram having been received via the specific command value object that is active, the actuator transmits a fault message to the bus.</p> <p>i This parameter is only visible if cyclical monitoring is enabled.</p>
<p><input type="checkbox"/> Cx - disabling function (x = 1 or 2) Disabling function</p>		<p>The fan coil actuator makes it possible to disable each of its fan coil channels via a bus telegram. During the disabling the valve and fan outputs can be set to a parameterised state, and can no longer be controlled via the bus. The outputs can then only be controlled via manual control directly on the device.</p> <p>The disabling function is disabled. The disabling object is hidden.</p> <p>The disabling function is enabled and the disabling object and the disabling parameter become visible in the ETS.</p>
	<p>deactivated</p>	
	<p>enabled</p>	

Polarity of the disabling object	0 = enabled; 1 = disabled	<p>The disabling function is activated and deactivated via the separate 1-bit communication object "Disabling function". The telegram polarity for this object can be set here.</p>
	1 = enabled; 0 = disabled	<p>i This parameter is only visible if the disabling function is enabled.</p>
Reaction at the beginning of the disabling function		<p>At the beginning of a disabling function the fan coil channel immediately enters the fault state configured here, provided that no function with a higher priority is activated at that instant. The possible parameter settings are dependent on the configured fan coil system.</p>
	no reaction	<p>The current valve position and fan level at the beginning of the disabling is adopted with no changes in the disabling. If the disabling is activated at the instant that a switching process or delay is running, or processing of a switch-on level, then the actuator still finishes the process completely.</p>
	Switch off all valve & fan outputs	<p>At the beginning of the disabling all valves are closed and the fan is switched off.</p>
	Heating with fan level	<p>At the beginning of the disabling the heating valve is opened. The fan is switched to the parameterised level. This parameter setting cannot be selected with the fan coil system "2-pipe heating/cooling".</p>
	Cooling with fan level	<p>At the beginning of the disabling the cooling valve is opened. The fan is switched to the parameterised level. This parameter setting cannot be selected with the fan coil system "2-pipe heating/cooling".</p>
	specified mode of operation with fan level	<p>The common valve for heating/cooling is opened in the event of a disabling function, if it is not open already. The fan is switched to the parameterised level. This parameter setting can only be selected with the fan coil system "2-pipe heating/cooling".</p>
		<p>i This parameter is only visible if the disabling function is enabled.</p>
Fan level	1...6 *	<p>This configures the fan level that should be set in the disabled state in active heating or cooling operation.</p>
	*: The selection is limited by the configured number of fan levels.	<p>i This parameter is only visible if the parameter "Reaction at the beginning of the disabling function" is configured with the following settings: "Heating with fan level", "Cooling with fan level" or "Specified mode of operation with fan level".</p>

i This parameter is only visible if the disabling function is enabled.

Reaction at the end of the disabling function

no reaction	At the end of a disabling function the fan coil channel immediately enters the state configured here, provided that no function with a higher priority is activated at that instant. The possible parameter settings are dependent on the configured fan coil system.
Switch off all valve & fan outputs	The valve position and fan level set at the beginning of the disabling is retained until a new command value and if necessary a mode of operation change-over is received, or until activation of a function with a lower priority (e.g. manual fan control). If "no reaction" is also parameterised at the beginning of the disabling, then at the end of the disabling the actuator retains the channel state that was set before the disabling. If the disabling is deactivated at the instant that a switching process or delay is running, or processing of a switch-on level, then the actuator still finishes the process completely.
Heating with fan level	At the end of the disabling all valves are closed and the fan is switched off. This state remains until a new command value and if necessary a mode of operation change-over is received, or until activation of a function with a lower priority (e.g. manual fan control).
Cooling with fan level	At the end of the disabling the heating valve is opened. The fan is switched to the parameterised level. This state remains until a new command value and if necessary a mode of operation change-over is received, or until activation of a function with a lower priority (e.g. manual fan control). This parameter setting cannot be selected with the fan coil system "2-pipe heating/cooling".
specified mode of operation with fan level	At the end of the disabling the cooling valve is opened. The fan is switched to the parameterised level. This state remains until a new command value and if necessary a mode of operation change-over is received, or until activation of a function with a lower priority (e.g. manual fan control). This parameter setting cannot be selected with the fan coil system "2-pipe heating/cooling".
specified mode of operation with fan level	The common valve for heating/cooling is opened at the end of the disabling, if it is not open already. The fan is switched to the parameterised level. This parameter

		tracked state	setting can only be selected with the fan coil system "2-pipe heating/cooling".
			At the end of the disabling the combination of valve position and fan level is set that corresponds to the command value last received during the disabling. If no command value has been received during the disabling, then the channel state last set at the beginning of the disabling is retained until a new command value is received. For fan coil systems with mode of operation change-over via the change-over object it is also necessary to specify a valid mode of operation.
			i This parameter is only visible if the disabling function is enabled.
Fan level	1...6 *		This configures the fan level that should be set at the end of the disabling function in active heating or cooling operation.
		*: The selection is limited by the configured number of fan levels.	
			i This parameter is only visible if the parameter "Reaction at the end of the disabling function" is configured with the following settings: "Heating with fan level", "Cooling with fan level" or "Specified mode of operation with fan level".
			i This parameter is only visible if the disabling function is enabled.
☐ Manual control			
Manual control in case of bus voltage failure	disabled		This parameter can be used for programming whether manual control is to be possible (enabled) or deactivated in case of bus voltage failure.
	enabled		
Manual control during bus operation	disabled		This parameter can be used for programming whether manual control is to be possible (enabled) or deactivated during bus operation (bus voltage on).
	enabled		
Disabling function ?	Yes		Manual control can be disabled via the bus, even if it is already active. For this purpose, the disabling object can be enabled here.
	No		
			i This parameter is only visible if manual control is enabled during bus operation.
Polarity of disabling object	0 = enabled; 1 = disabled		This parameter defines the polarity of the disabling object.
	0 = disabled; 1 = enabled		i This parameter is only visible if manual control is enabled during bus operation.
Transmit status ?			The current state of manual control can be transmitted to the bus via a separate

<p>Yes</p> <p>No</p> <p>Status object function and polarity</p>	<p>Yes</p> <p>No</p> <p>0 = inactive; 1 = manual control active</p> <p>0 = inactive; 1 = permanent manual control active</p>	<p>status object, if bus voltage is available (setting: "Yes").</p> <p>i This parameter is only visible if manual control is enabled during bus operation.</p> <p>This parameter defines the information contained in the status object. The object is always "0", when the manual control mode is deactivated.</p> <p>The object is "1" when the manual control mode is active (temporary or permanent).</p> <p>The object is "1" only when the permanent manual control is active.</p> <p>i This parameter is only visible if manual control is enabled during bus operation.</p>
<p>Behaviour at the end of permanent manual control during bus operation</p>	<p>no change</p>	<p>The behaviour of the actuator at the end of permanent manual control depends on this parameter.</p> <p>All telegrams received while permanent manual control is active (e.g. command value telegrams, telegrams for mode of operation change-over or for activation of a disabling function or fan level limitation or switching telegram of the simple switching outputs) will be rejected. After the end of the permanent manual control mode, the current state of all outputs remains unchanged. If, however, a disabling function, a level limitation or manual fan control or other functions with a lower priority than manual control, but a higher priority than normal operation (bus operation via command values and mode of operation change-over) has been activated via the bus before or during manual control, then the actuator executes these functions again for the fan coil channels concerned.</p>
	<p>output tracking</p>	<p>During active permanent manual control all incoming bus telegrams are tracked internally. At the end of manual control, all outputs are adjusted to the tracked states. The individual priorities of the functions with respect to one another are taken into account here; in each case only the function with the higher priority is executed. If during manual control no bus telegrams are received, the internally tracked state corresponds to the state before the manual control.</p>

5 Appendix

5.1 Index

B		P	
Bus or mains voltage return.....	54	Parameter "Command value lower limits"	.. 108
Bus voltage failure.....	52	Parameter "Controlling the fan levels" ..	108
C		Parameter "Cyclical monitoring of the command values"	.. 117
Cyclical command value monitoring.....	90	Parameter "Delay after bus voltage return"	.. 104
D		Parameter "Disabling function".....	119
Disabling function.....	94	Parameter "Fan level when the fan is switched on"	.. 109
Dwell time.....	73	Parameter "Fan protection".....	107
E		Parameter "Feedback for 'fan coil active'"	.. 113
ETS programming.....	52	Parameter "Hysteresis for level change-over"	.. 109
ETS search paths.....	22	Parameter "Level limitation via object" ..	111
F		Parameter "Manual control".....	122
Fan coil - definition of terms and functional principle	.. 32	Parameter "Manual fan control".....	115
Fan coil - functional differences.....	34	Parameter "Number of fan levels".....	107
Fan coil channels.....	36	Parameter "Read request".....	106
Fan coil system.....	38	Parameter "Switch-off delay".....	110
Fan level control.....	60	Parameter "Switch-on delay".....	110
Fan level definition.....	62	Parameter "Type of feedback".....	112
Fan protection.....	57	Parameter "Valve protection".....	106
Feedback for "Fan coil active".....	79	Pause "OFF".....	72
Feedback for active fan level.....	78	Presetting manual control behaviour.....	48
Feedback telegrams for bus behaviour	.. 80	Priorities.....	98
L		S	
Level limitation.....	75	Safe-state mode.....	25
M		Scope of functions.....	23
Manual control.....	47	Setting fan coil channels.....	37
Manual control - all outputs OFF.....	18	Setting the fan coil system.....	44
Manual control - control output.....	17	Setting the hysteresis.....	65
Manual control - disabling bus control..	18, 51	State as supplied.....	101
Manual control - indicators and control..	12	Switch-off delay for the fan.....	70
Manual control - priorities.....	16	Switch-on delay for the fan.....	69
Manual control mode disabling function	.. 50	Switch-on level.....	66
Manual control status message.....	50	T	
Manual fan control.....	83	Type of fan coil system.....	102
N		V	
Number of fan levels.....	59	Valve protection.....	56
O		Version of application program.....	25
Output assignments.....	99		

ALBRECHT JUNG GMBH & CO. KG
Volmestraße 1
D-58579 Schalksmühle

Telefon: +49.23 55.8 06-0
Telefax: +49.23 55.8 06-1 89
E-mail: mail.info@jung.de
Internet: www.jung.de
www.jung-katalog.de