



## Product documentation

**LED-Controller 5gang**  
 Ref. No. 39 005 1S LED R  
 39 005 1S LED E



390051SLEDE



390051SLEDR

**ALBRECHT JUNG GMBH & CO. KG**  
 Volmestraße 1  
 58579 Schalksmühle  
 GERMANY

Telefon +49 (0) 23 55/80 60  
 Telefax +49 (0) 23 55/80 61 89  
 kundencenter@jung.de  
[www.jung.de](http://www.jung.de)

## Table of Contents

|          |   |    |
|----------|---|----|
| 1.       | Information on the product.....                   | 4  |
| 1.1.     | Product catalogue.....                            | 4  |
| 1.2.     | Function.....                                     | 4  |
| 2.       | Safety instructions and Device components.....    | 6  |
| 2.1.     | Safety instructions.....                          | 6  |
| 2.2.     | Device components.....                            | 6  |
| 3.       | Function.....                                     | 7  |
| 3.1.     | System information.....                           | 7  |
| 3.2.     | Intended use.....                                 | 7  |
| 3.3.     | Product characteristics.....                      | 7  |
| 4.       | Mounting and electrical connection.....           | 8  |
| 4.1.     | Information for electrically skilled persons..... | 8  |
| 4.2.     | Mounting.....                                     | 8  |
| 4.3.     | Connection.....                                   | 8  |
| 4.3.1.   | Connection plan.....                              | 9  |
| 4.3.1.1. | Connection plan RGBCCT.....                       | 10 |
| 4.3.1.2. | Connection plan RGBW.....                         | 10 |
| 4.3.1.3. | Connection plan RGB + TW.....                     | 10 |
| 4.3.1.4. | Connection plan TW.....                           | 11 |
| 4.3.2.   | Overcurrent shutdown and illuminant.....          | 11 |
| 5.       | Commissioning.....                                | 11 |
| 5.1.     | Switch on.....                                    | 11 |
| 6.       | Operation.....                                    | 12 |
| 6.1.     | Display.....                                      | 12 |
| 6.1.1.   | Commissioning functions.....                      | 13 |
| 6.2.     | LED displays.....                                 | 16 |
| 6.3.     | Programming mode.....                             | 16 |
| 6.4.     | Master Reset.....                                 | 16 |
| 7.       | Configuration.....                                | 17 |
| 7.1.     | Dimming characteristics.....                      | 17 |
| 7.2.     | Dimming behavior.....                             | 19 |
| 7.3.     | Limit dimming range.....                          | 19 |
| 7.4.     | Measurements and counters.....                    | 20 |
| 7.4.1.   | Measurements.....                                 | 20 |
| 7.4.2.   | Counter.....                                      | 20 |
| 7.5.     | Alarm objects and protection functions.....       | 20 |
| 7.5.1.   | Illuminant protection.....                        | 21 |
| 7.5.2.   | Power supply protection.....                      | 22 |
| 7.6.     | Channel functions.....                            | 23 |
| 7.6.1.   | RGB.....  | 23 |
| 7.6.2.   | RGBCCT: Extended-RGB.....                         | 24 |

|          |  |    |
|----------|--|----|
| 7.6.3.   | RGBW .....   | 25 |
| 7.6.4.   | Color spaces RGB and HSV .....                             | 26 |
| 7.6.5.   | Color temperature control .....                            | 27 |
| 7.6.6.   | Time-controlled dimming and Human Centric Light (HCL)..... | 31 |
| 8.       | ETS Application .....                                      | 32 |
| 8.1.     | Specification.....   | 32 |
| 8.2.     | Parameter .....  | 32 |
| 8.2.1.   | General .....  | 32 |
| 8.2.1.1. | Configuration.....   | 33 |
| 8.2.1.2. | Dimming settings .....                                     | 36 |
| 8.2.1.3. | Time functions.....  | 39 |
| 8.2.1.4. | External power relay .....                                 | 40 |
| 8.2.2.   | Measurements and meter .....                               | 42 |
| 8.2.2.1. | Measurements .....   | 43 |
| 8.2.2.2. | Meter.....   | 44 |
| 8.2.3.   | Alarm objects and protection functions.....                | 45 |
| 8.2.3.1. | Additional device protection.....                          | 46 |
| 8.2.3.2. | Illuminant protection.....                                 | 47 |
| 8.2.3.3. | Power supply protection.....                               | 48 |
| 8.2.4.   | Channel configuration .....                                | 49 |
| 8.2.4.1. | Single channel .....                                       | 49 |
| 8.2.4.2. | RGB - Configuration.....                                   | 51 |
| 8.2.4.3. | RGBW – White channel.....                                  | 52 |
| 8.2.4.4. | RGBCCT (as RGB-Extended) – White channel .....             | 53 |
| 8.2.4.5. | Tunable White - Configuration .....                        | 55 |
| 8.2.4.6. | RGBCCT (as TW-Extended) - Configuration.....               | 59 |
| 8.2.4.7. | RGBW (as Virtualized TW) - Configuration .....             | 60 |
| 8.2.5.   | Enabled functions .....                                    | 61 |
| 8.2.5.1. | Stairway function.....                                     | 62 |
| 8.2.5.2. | Scenes .....   | 64 |
| 8.2.5.3. | Bit scenes .....   | 66 |
| 8.2.5.4. | Disabling functions.....                                   | 67 |
| 8.2.5.5. | Sequences .....  | 69 |
| 8.2.5.6. | Time-controlled dimming or HCL .....                       | 73 |
| 8.3.     | Communication objects .....                                | 75 |
| 9.       | Firmware-Update.....                                       | 84 |
| 9.1.     | Display firmware version.....                              | 84 |
| 9.2.     | Preparing firmware update .....                            | 84 |
| 9.3.     | Performing a firmware update .....                         | 84 |
| 10.      | Technical Data .....                                       | 85 |

# 1. Information on the product

## 1.1. Product catalogue

|               |                             |
|---------------|-----------------------------|
| Product name: | LED-Controller              |
| Use:          | Dimming actuator            |
| Bauform:      | RMD or ceiling installation |
| Order No.:    | 390051SLEDR, 390051SLEDE    |

## 1.2. Function

Up to five LED channels can be switched and dimmed via the KNX bus. In total, the dimmer can dim 20A LED current, whereby the power can be distributed as desired over all channels. The total load of the five channels is thereby optimally distributed by the dimming sequencer over the complete switching cycle, which significantly reduces stress on the integrated circuit, as well as on the components of the upstream LED power supply, thereby increasing the expected lifetime of the components

Lighting scenes can be pre-configured, stored and replayed, also using 1-bit group addresses, to implement lighting control with a simple motion detector, for example: The scene then retrieves a specific color mixture, e.g. of the RGB – illuminants.

Sequences are procedures of color controls in the range of seconds to hours. Thus the lighting is changed e.g. with smooth color changes over a certain period of time. The Device has predefined color sequences. This makes the use of this "mood lighting" very easy during commissioning. In addition, the parameterization of own color sequences is possible with the help of the ETS application.

Furthermore, time-controlled sequences are also available, with the help of which the illuminants can be controlled differently depending on the time or relative to sunrise or sunset.

A "stairway lighting function" is also available for all operating modes, which makes it possible to switch off, for example, a light triggered by a motion detector after a parameterizable time.

The Device can be adapted to one of the following applications:

- Five independent channels
- RGB CCT: One channel color (Red / Green / Blue / Cool White / Warm White)
  - Application A: Extended RGB: RGB color control with optional automatic white balance
  - Application B: Extended TW: RGB color control with optional extended TW range
- RGBW: One channel color (red / green / blue / white) + one independent channel
  - Application A: Extended RGB: RGB color control with optional automatic white balance
  - Application B: Virtualized TW: RGB color control with virtualized TW range
- RGB: One channel color (Red / Green / Blue) + two independent channels or one Tunable White channel (Cool White / Warm White)
- Two Tunable White channels (cool white / warm white) + one independent channel
- One Tunable White channel + three independent channels

The colors can be controlled either via the primary colors red, green and blue (color mode RGB) or via hue, saturation and brightness (color mode HSV).

The control of the color temperature for Tunable White channels takes place either via the percentage of cold white light or via the specification of a temperature value in Kelvin.

Undervoltage, overcurrent and overtemperature can be detected via communication objects. These protective functions, which have been "implemented in hardware" represent an important feature of the device. In these cases, the protection function automatically switches off the connected LED modules. The shutdown is specific, i.e. if an error is only present on one channel, only this channel will be shut down. After elimination of the error, the dimmer restarts automatically.

In addition, the device has an integrated reverse polarity protection, so that during commissioning possible damage due to reverse polarity of the input is excluded. The output (connection of the LED modules) is not critical for the device in this respect.

In addition to these integrated protection functions, protection functions for illuminants or power supply units can also be parameterized. By entering the continuous power and overload capacity of the illuminants or the power supply unit, overload scenarios can be detected. These can be signaled by group objects and, if desired (parameterizable), also lead to shutdown.

The measured values required for these protective functions, such as power supply voltage, current, voltage at the lamp and internal housing temperature, are also made available to the user by means of communication objects. Integrated energy and energy cost counters also provide a detailed cost breakdown of the installed illuminants.

For simple diagnostics and error analysis on the KNX-bus, measured values are available for the average or maximum telegram rate (send direction), as well as a parameterizable telegram rate limitation.

## 2. Safety instructions and Device components

### 2.1. Safety instructions



Electrical devices may only be mounted and connected by electrically skilled persons. Serious injuries, fire or property damage possible. Please read and follow manual fully. Danger of electric shock. During installation and cable routing, comply with the regulations and standards which apply for SELV circuits. These instructions are an integral part of the product and must remain with the end customer.

### 2.2. Device components

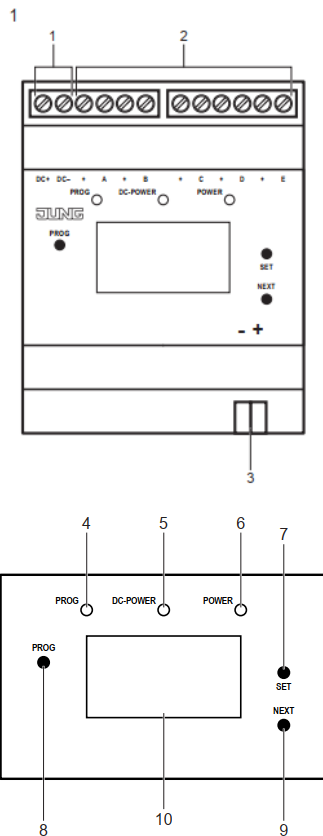

Figure 1: 390051SLEDR

- |                 |                |
|-----------------|----------------|
| 1. KNX          | 6. LED POWER   |
| 2. LED-Modules  | 7. Button SET  |
| 3. Power supply | 8. Button PROG |
| 4. LED PROG     | 9. Button NEXT |
| 5. LED DC-POWER | 10. Display    |

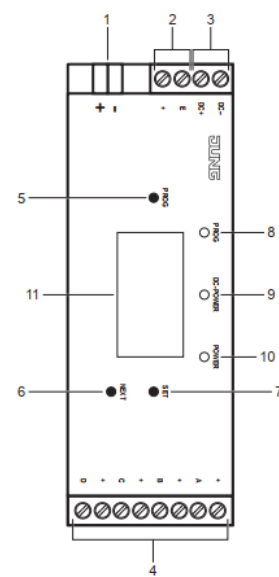

Figure 2: 390051SLEDE

- |                 |                 |
|-----------------|-----------------|
| 1. KNX          | 5. Button PROG  |
| 2. LED-Modules  | 6. Button NEXT  |
| 3. Power supply | 7. Button SET   |
| 4. LED-Modules  | 8. LED PROG     |
|                 | 9. LED DC-POWER |
|                 | 10. LED POWER   |
|                 | 11. Display     |

## 3. Function

### 3.1. System information

The device can be updated. Firmware can be easily updated. The device is KNX Data Secure capable. KNX Data Secure offers protection against manipulation in building automation and can be configured in the ETS project. Detailed specialist knowledge is required. A device certificate, which is attached to the device, is required for safe commissioning. During mounting, the certificate must be removed from the device and stored securely. Planning, installation, and commissioning of the device are carried out with the aid of the ETS, version 5.7 and above

### 3.2. Intended use

- Dimmer to control LEDs, LED modules, LED spots, halogen lamps and incandescent lamps of between 5 V ... 48 V (pulse width-modulated)
- 39005 1S LED R: Mounting on DIN rail according to EN 60715 in distribution boxes
- 39005 1S LED E: Mounting in false ceilings on surfaces or in/under furniture

### 3.3. Product characteristics

- Dimmer for colour temperature and coloured light control (RGB/HSV)
- Different dimming characteristics settable (soft dimming, deep-down dimming)
- PWM frequency settable (211 ... 1200 Hz)
- Commissioning with display support
- Free configuration of the channels
- Integrated scenes and bit scenes
- Predefined and freely-definable sequences
- Time-controller dimming or Human Centric
- Lighting (HCL)
- Staircase light function
- Disabling function
- Measurement and meter function
- Diagnostics/message of the protection function via
- KNX group addresses and shown on display
- Electronic overtemperature switch-off of the load current (automatic reset)
- Protection functions for LED modules and power supply

## 4. Mounting and electrical connection

### 4.1. Information for electrically skilled persons



**DANGER**

Electrical shock on contact with live parts in the installation environment. Electrical shocks can be fatal. Before working on the device, disconnect the power and cover live parts in the area

### 4.2. Mounting

- 39005 1S LED R: Mount device on DIN rail
- 39005 1S LED E: Mounting the device in false ceilings, on surfaces or in/under furniture

### 4.3. Connection

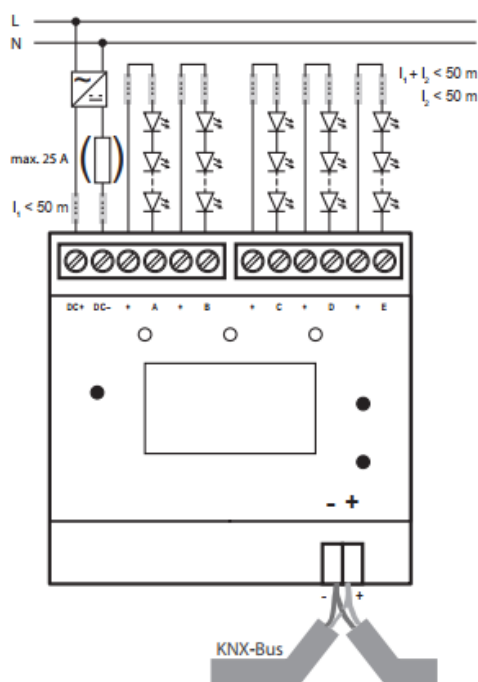

Figure 3: 390051SLEDR

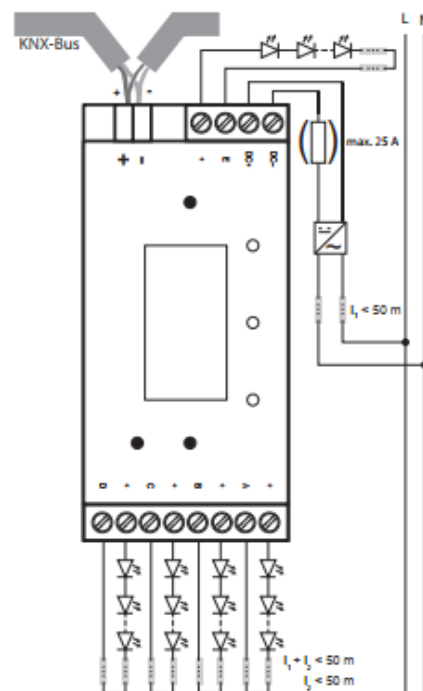

Figure 4: 390051SLEDE

#### Requirements

- Power supply (5 ... 48 V DC)
- KNX bus connection
- For position of the connections, see device components
  - Connect the power supply to the DC+ and DC- according to the connection
  - DC-POWER LED lights up in yellow

**i** With power supplies with a rated current < 25 A and overload and/or overcurrent function, it is not necessary to use a fuse.

- Connect KNX
- Connect the LED modules



### 4.3.1. Connection plan

KNX bus, LED power supply and LED modules must be connected to the device according to the specification. The following applies for the assignment of colors to the outputs:

| Channel Mode         | Cannel A                   | Cannel B                   | Cannel C                   | Cannel D                   | Cannel E                   |
|----------------------|----------------------------|----------------------------|----------------------------|----------------------------|----------------------------|
| <b>RGBCCT</b>        | Red                        | Green                      | Blue                       | Cold white                 | Warm white                 |
| <b>RGBW + 1x IC</b>  | Red                        | Green                      | Blue                       | White                      | Independent single channel |
| <b>RGB + 2x IC</b>   | Red                        | Green                      | Blue                       | Independent single channel | Independent single channel |
| <b>RGB + 1 x TW</b>  | Red                        | Green                      | Blue                       | Cold white                 | Warm white                 |
| <b>2x TW + 1x IC</b> | Cold white                 | Warm white                 | Cold white                 | Warm white                 | Independent single channel |
| <b>1x TW + 3x IC</b> | Cold white                 | Warm white                 | Independent single channel | Independent single channel | Independent single channel |
| <b>5 x IC</b>        | Independent single channel | Independent single channel | Independent single channel | Independent single channel | Independent single channel |

Table 1: Channel assignment

Connect the external power supply to the screw terminals DC+ and DC- according to the connection diagram. When using a power supply whose rated current is less than 25 A and which also has an overload or overcurrent protection function, it is not necessary to install the fuse shown in the above diagram. The power supply must be certified according to the lamp standards IEC 61347-1 and 61347-2-13. We recommend the Enerutex LED PowerSupply 160.

If the overload or an overcurrent protection function is not available in the set power supply, the additional fuse against it is necessary. If the power supply does not meet the lamp standards, the operation is not allowed.

Lead wires to lighting are to be connected to the terminal A+, B+, C+, D+ or E+ according to the connection diagram. If the total current is permissible (observe the conductor crosssection!), a common forward conductor can be used for several lamp strings.

In this case, this forward conductor can be connected to any + terminal, since the outputs A+, B+, C+, D+ or E+ are internally connected to each other.

Return conductors from lighting are to be connected to terminal A-, B-, C-, D- or E- according to the connection diagram. The maximum load per channel and the maximum total load over all channels must not be exceeded!

4.3.1.1. Connection plan RGCCT

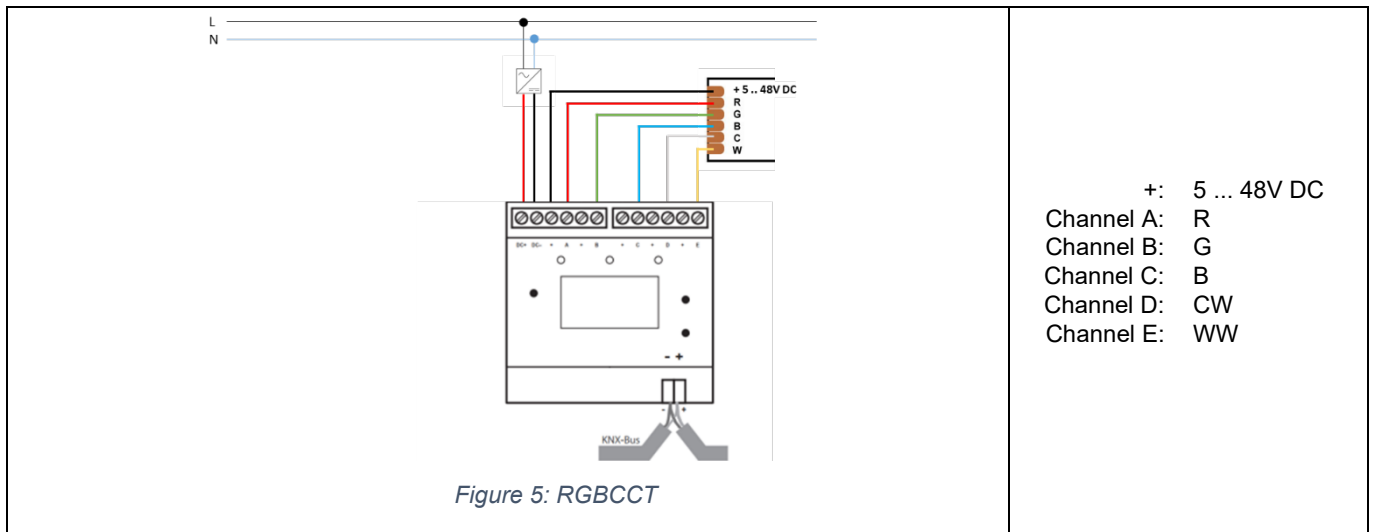

4.3.1.2. Connection plan RGBW

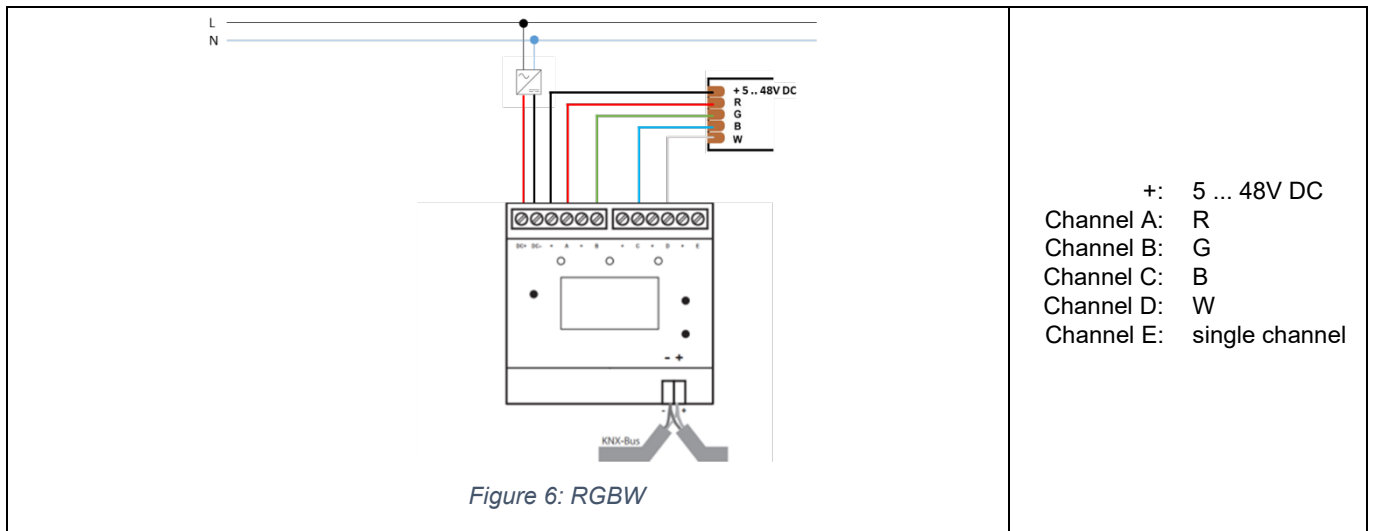

4.3.1.3. Connection plan RGB + TW

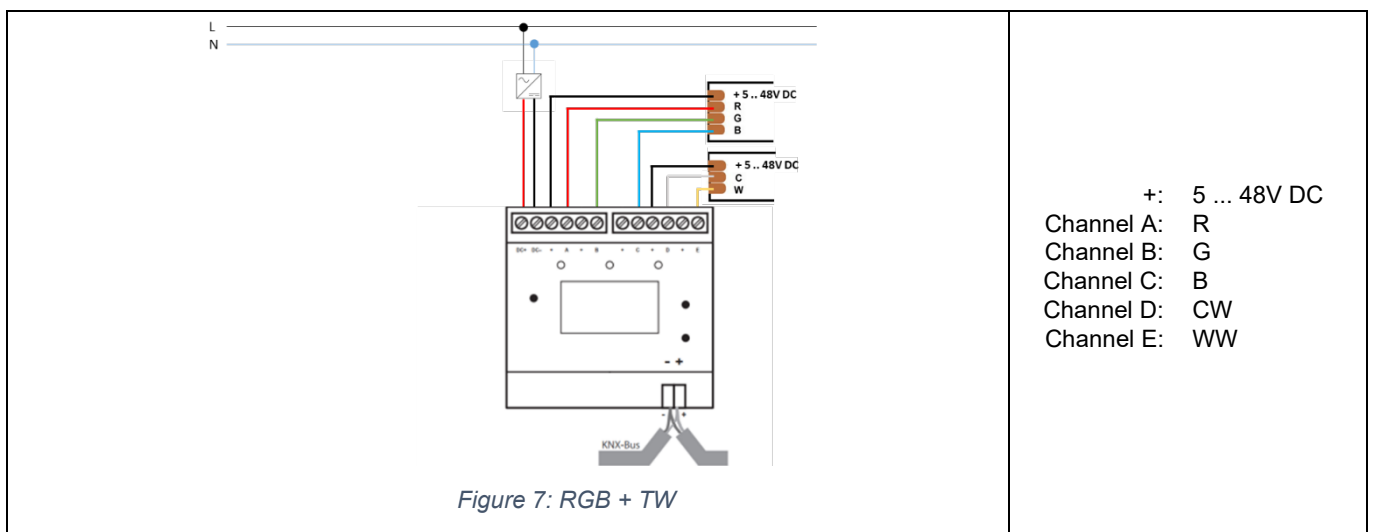

4.3.1.4. Connection plan TW

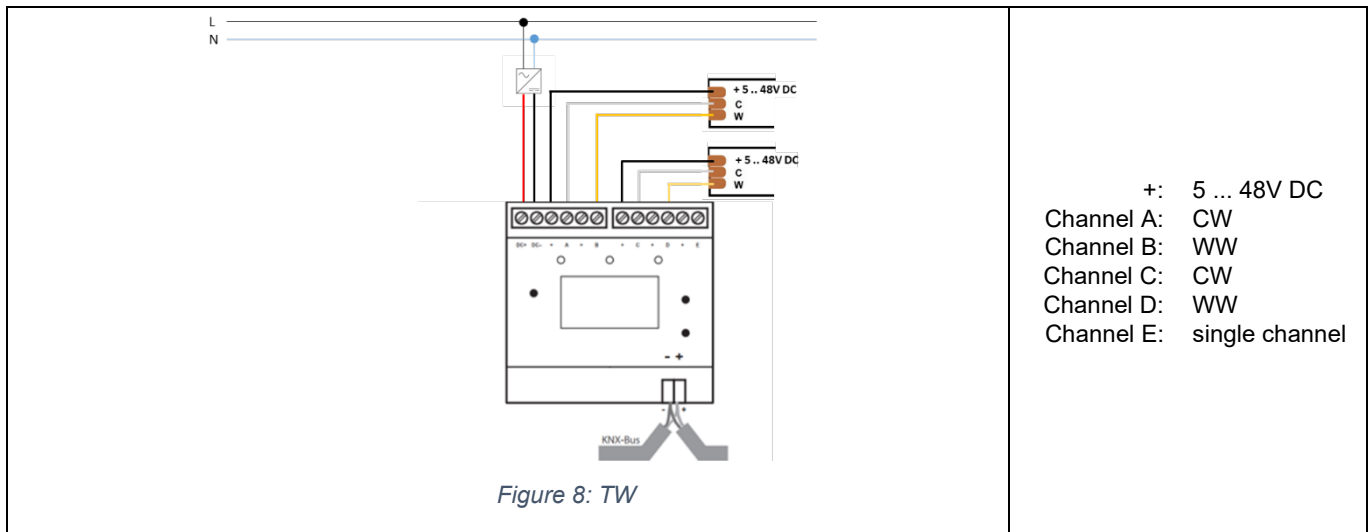

4.3.2. Overcurrent shutdown and illuminant

A common characteristic of LED lamps is a very high inrush current, which is often many times higher than the continuous current during operation. For error-free and safe operation, the LED controller must be able to distinguish the inrush current from the continuous current. At this device, the overcurrent shutdown has been dimensioned in such a way that it reliably switches off continuous currents of over 20 A, but does not consider inrush currents of up to 100 A as a fault condition.

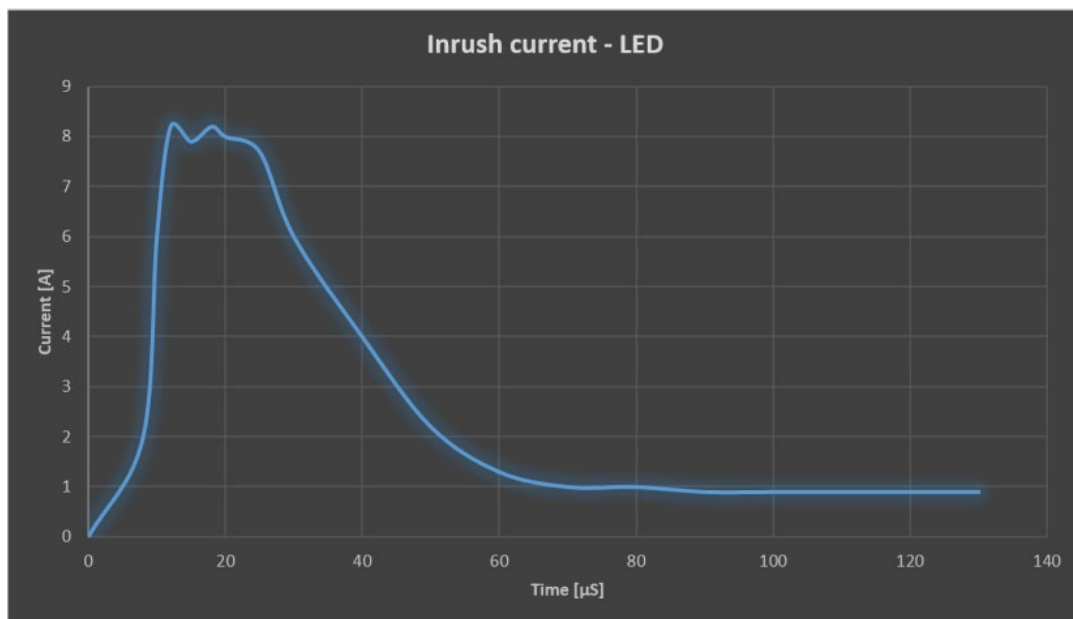

Figure 9: Inrush current

5. Commissioning

5.1. Switch on

After connecting, the device is switched on automatically. The POWER LED turns green.

## 6. Operation

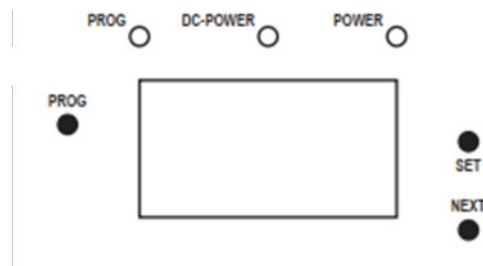

Figure 10: Display

### 6.1. Display

The display switches itself off automatically after one minute

- Switching on display:
  - Press the NEXT button
- Scrolling through menu:
  - Press the NEXT button repeatedly while the display is switched on
- Menu structure
  - Page 1, 2 and 3:
    - Display of the status of the power supply/ LED modules
    - overvoltage, undervoltage, overtemperature
    - protective functions
    - the overcurrent total/single channel
  - Page 4:
    - 1-Touch-Commissioning and status total
  - Page 5, 6 und 7:
    - 1-Touch-Commissioning status channel A ... E
  - Page 8:
    - Test mode of various dimming properties
  - Page 9 and 10:
    - Display of the current measurement, DC voltage measurements, bus and device temperatur
  - Page 11 and 12:
    - Display of the brightness and adjustment of the channels in percent
  - Page 13:
    - Display of various device properties
  - Page 14:
    - Displaying the Data Secure FDSK (Factory Default Setup Key)
      - This is only displayed if the device has not yet been set to secure mode

### 6.1.1. Commissioning functions

In addition to the simple readout of various measured variables, the integrated display user interface also releases the temporary adjustment of some parameters for optimum adaptation to the illuminant (test modes). This means that by means of these commissioning functions, for example, the desired dimming curve can be quickly determined by trial and error, but the permanent parameterization must then be carried out as usual in the ETS.

Furthermore, the UI offers the possibility of a 1-touch commissioning: In this case, the dimmer moves each channel once to 100% and measures current and voltage there. This is a simple way to verify the correct wiring and dimensioning of the system (power supply, dimming sequencer, lamps).

Navigation in the UI is done by means of the DISPLAY and SET buttons

- NEXT: Next page / Next entry
- SET: Select entry

| # | Page name | Designation       | Description   |
|---|-----------|-------------------|---|
| 1 | Alarms 1  | UnderVoltage      | Alarm undervoltage (LED power supply)<br>Possible status:<br>OK: Voltage OK<br>ALARM: Undervoltage<br>N/A: Value not yet available (first 2 seconds after startup)          |
|   |           | OverVoltage       | Alarm overvoltage (LED power supply)<br>Possible status:<br>OK: Voltage OK<br>ALARM: Overvoltage<br>N/A: Value not yet available (first 2 seconds after startup)            |
|   |           | OverTemperature   | Alarm overtemperature (dimmer internal)<br>Possible status:<br>OK: Temperature OK<br>ALARM: Overtemperature<br>N/A: Value not yet available (first 2 seconds after startup) |
|   |           | OverCurrent Total | Alarm overcurrent sum<br>Possible status:<br>OK: Total current OK<br>ALARM: Total overcurrent<br>N/A: Value not yet available (first 2 seconds after startup).              |
| 2 | Alarms 2  | OverCurrent A     | Alarm overcurrent channel ...<br>Possible status:<br>OK: Channel current OK<br>ALARM: Channel overcurrent<br>N/A: Value not yet available (first 2 seconds after start-up)  |
|   |           | OverCurrent B     |   |
|   |           | OverCurrent C     |   |
|   |           | OverCurrent D     |   |
|   |           | OverCurrent E     |   |

Table 2: User Interface Display

| # | Seitenname              | Bezeichnung                                    | Description   |
|---|-------------------------|--|---|
| 3 | Protection              | PowerSupply                                    | Power supply protection<br>Possible status:<br>OK: Power supply protection active, no error<br>CONT: Power supply protection active, continuous power exceeded<br>I2T: Power supply protection active, I <sup>2</sup> t value exceeded<br>MAX: Power supply protection active, maximum power exceeded<br>UNLOADED: Power supply protection inactive, application discharged<br>N/A: Power supply protection inactive, deactivated in parameters |
|   |                         | Protection A                                   | Illuminant protection channel<br>Possible status: like Protection/PowerSupply   |
|   |                         | Protection B                                   |   |
|   |                         | Protection C                                   |   |
|   |                         | Protection D                                   |   |
|   |                         | Protection E                                   |   |
| 4 | 1-Touch-Commissioning 1 | START  | Use SET to switch to the START menu:<br>START: Starts 1-touch commissioning<br>Cancel: Termination  |
|   |                         | Status   | Displays the status of 1-touch commissioning - possible status:<br>Standby: 1-touch commissioning has not yet been executed.<br>Dim A: Dim channel A high<br>Check A: Measure current and voltage channel A<br>Dim All: Dim all channels high<br>Check All: Measure total current and voltage<br>Completed: 1-touch commissioning completed<br>N/A: Status undefined  |
|   |                         | MaxCurrTot                                     | Maximum total current<br>N/A: Measurement not yet performed   |
|   |                         | MaxPoweSup                                     | Maximum power at power supply<br>N/A: Measurement not yet performed   |
|   |                         | MinVoltSup                                     | Minimum voltage at power supply (max. power)<br>N/A: Measurement not yet performed  |
|   |                         | <Exit>   | Change from operating mode to display mode  |
|   |                         |  |   |
| 5 | 1-Touch-Commissioning 2 | MaxCurrA                                       | Maximum current channel A<br>N/A: Measurement not yet performed   |
|   |                         | MaxPoweA                                       | Maximum power channel A<br>N/A: measurement not yet performed   |
|   |                         | MinVoltA                                       | Minimum voltage on the illuminant A (corresponds to the CO commissioning voltage A). N/A: measurement not yet performed   |
|   |                         | MaxCurrB                                       | Maximum current channel B N/A: measurement not yet performed  |
|   |                         | MaxPoweB                                       | Maximum power channel B N/A: measurement not yet performed  |
|   |                         | MinVoltB                                       | Minimum voltage on the illuminant B (corresponds to the CO commissioning voltage B). N/A: measurement not yet performed   |
| 6 | 1-Touch-Commissioning 3 | Follow-up channels analog to 1-touch startup 2 | Follow-up channels analog to 1-touch startup 2  |
| 7 | 1-Touch-Commissioning 4 | Follow-up channels analog to 1-touch startup 2 | Follow-up channels analog to 1-touch startup 2  |

|    |                   |                 |  |
|----|-------------------|-----------------|--|
| 8  | Test modes        | Test pwm freq 1 | Use SET to switch to the frequency test menu. Use DISPLAY to switch through the different frequencies. All channels oscillate with the selected frequency. SET or terminates the test mode. The frequency is not permanently adopted (test mode).              |
|    |                   | Test pwm freq 2 |  |
|    |                   | Test dim curve  | Use SET to switch to the dimming curve test menu. Use DISPLAY to switch through the various dimming curves. All channels oscillate with the selected dimming curve. SET or terminates the test mode. The dimming curve is not permanently adopted (test mode). |
|    |                   | Test dim speed  | Use SET to switch to the dimming speed test menu. Use DISPLAY to switch through the different speeds. All channels oscillate at the selected speed. SET or terminates the test mode. The speed is not permanently adopted (test mode).                         |
|    |                   | Switch all      | Use SET to switch to the Switch All menu. Use DISPLAY to select whether to switch ON or OFF. SET executes the selected option. All channels oscillate with the selected speed. The menu can be exited by pressing  |
|    |                   | <Exit>          | Change from operating mode to display mode   |
| 9  | Current           | Current Total   | Current measurement total N/A: Value not yet available (first 2 seconds after startup).<br>Current measurement channel<br>N/A: Value not yet available (first 2 seconds after start)   |
|    |                   | Current A       |  |
|    |                   | Current B       |  |
|    |                   | Current C       |  |
|    |                   | Current D       |  |
|    |                   | Current E       |  |
| 10 | Voltage / Temp    | PowerSupply     | Voltage measurement DC input   |
|    |                   | KNX bus         | KNX bus voltage  |
|    |                   | Temp            | Device temperature (corresponds to the communication object Device temperature)  |
| 11 | Brightness        | Brightness A    | Channel brightness   |
|    |                   | Brightness B    |  |
|    |                   | Brightness C    |  |
|    |                   | Brightness D    |  |
|    |                   | Brightness E    |  |
| 12 | Change Brightness | Brightness A    | Use SET to switch to the brightness change menu.<br>Use DISPLAY to select whether to dim up (+) or down (-).<br><OK> accepts the current dimming value<br><CANCEL> exit menu   |
|    |                   | Brightness B    |  |
|    |                   | Brightness C    |  |
|    |                   | Brightness D    |  |
|    |                   | Brightness E    |  |
|    |                   | <Exit>          | Change from operating mode to display mode   |

|    |             |               |   |
|----|-------------|---------------|---|
| 13 | Device info | Phy. address  | Individual adress (KNX)   |
|    |             | Serial number | Serial number   |
|    |             | FW version    | Firmware version  |
|    |             | HW revision   | Hardware revision   |
|    |             | Time valid    | Displays the current time<br>INVALID, if not set                        |
|    |             | Date valid    | Displays the current date<br>INVALID, if not set                        |
| 14 | FDSK        | FDSK          | Key for Secure commissioning<br>not visible if device is in secure mode |

## 6.2. LED displays

There are three LEDs on the front of the device. The LEDs indicate the following device statuses during operation:

- LED PROG lights up red:  
Programming mode is activated
- LED DC-POWER lights up yellow:  
Voltage at DC input is normal
- LED POWER lights up green:  
Device is ready for operation

## 6.3. Programming mode

Programming Device:

- Press the PROG button.  
PROG LED lights up red
- Terminate programming mode:  
Press the PROG button again

## 6.4. Master Reset

- Ensure that the device is switched off (disconnect bus voltage)
- Press PROG button, hold it and connect device  
Device switches on.
- Hold PROG button until PROG LED flashes slowly (approx. 1 Hz).
- Release PROG button
- Press PROG button again and hold it until PROG LED flashes fast (approx. 4 Hz).  
The master reset starts.
- Release PROG button



## 7. Configuration

This chapter provides background information on the various application scenarios and parameterization options of the device. A detailed description of the ETS application follows later in the chapter ETS Application. Within the individual chapters, there are often cross-references to the corresponding parameter descriptions. The parameter descriptions contain cross-references to the explanations.

### 7.1. Dimming characteristics

The device offers four different dimming curves to choose from:

- Linear
- Exponential
- Power function
- JUNG

The human eye generally perceives brightness values logarithmically, i.e. at twice the light intensity, the human eye does not perceive the brightness to be twice as high, but much lower. Although effects such as pupil aperture and the light-dark adaptation of the visual cones and rods also play a major role, visual perception is often modeled logarithmically. It is assumed that, for example, with double illumination, the "perceived" brightness increases by a factor of only 1.4.

Control via KNX-compliant % values is performed in a total of 255 steps. Therefore, the control of the LEDs is done in 255 discrete steps.

These control points (=brightness of the LED) must be distributed by the device over the possible dimming range. The dimming characteristic of the dimmer can be set in the ETS application.

**Note:**

The following statements about perception are partly subjective and may differ from person to person in individual cases. The actual perception also depends on other factors, such as the LEDs, their integrated control circuitry, their characteristic curves, etc. Nevertheless, the tendency of the differences should be clarified.

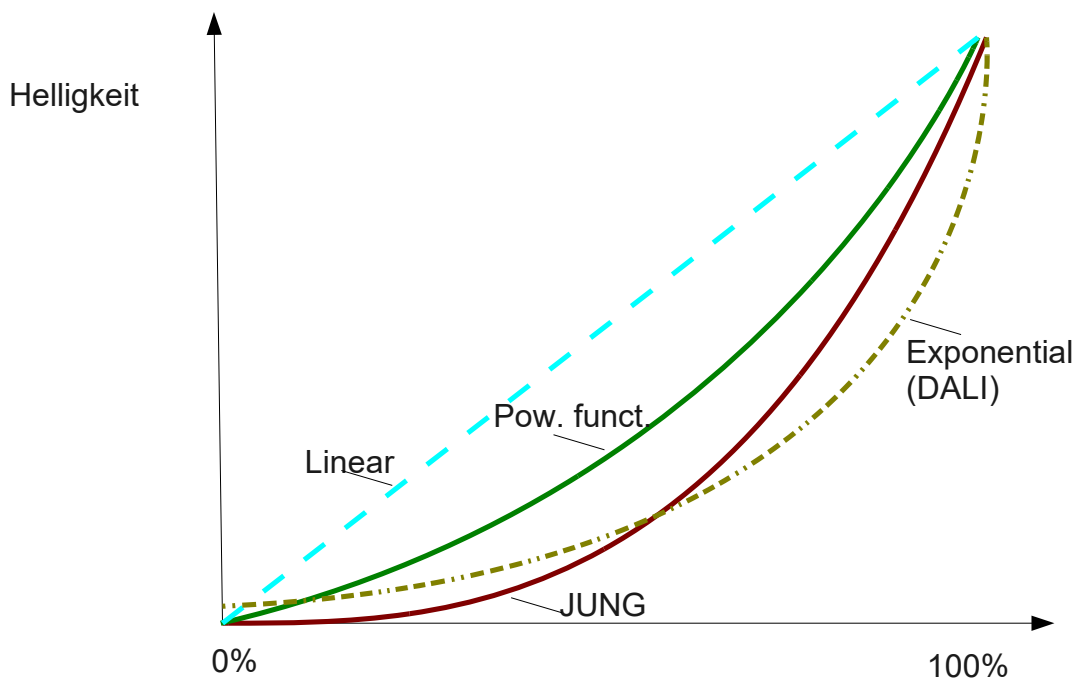

Figure 11: Dimming characteristics

### **Linear**

For humans, an increase in the upper range of the control (> 80% to 100%) is usually perceived as smaller with this characteristic curve. In the lower range (<10%), on the other hand, a small increase in the control value will have a large effect for the human eye. In the range 40 to 60%, the subjective perception of the brightness change is often quite good.

Note: If the CW component is shifted in the cold/warm white operating mode with the corresponding objects, this will result in a slight "dent" in the sum brightness during the dimming process, if a dimming curve other than the linear one is selected. If this behavior is not acceptable, the linear curve must be selected in this case. At the end of the dimming process, the total brightness for each curve is then equal to the initial brightness again.

### **Exponential**

Based on the assumption that the perception is logarithmic, an exponential control is implemented for DALI illuminants, for example (inverse function). This is provided with an offset in the lower range, i.e. when the LEDs are switched on, a clear jump in brightness will be perceptible once. Often the LEDs cannot be dimmed down to the lower limit with this characteristic. In the range up to 40%, the dimming behavior is very soft and largely corresponds to perception. From about 50%, the step is relatively large, so that the increase by a few percentage steps can pretend to the perception of a significantly higher increase. Overall, this dimming curve of the device is based on the DALI standard.

### **Power function**

In the upper dimming range (from 60%), this dimming curve usually reproduces the perception regarding brightness very well. In the range up to 10%, the gradation is better adapted to the eye than is the case with the linear curve, but subjectively less good than the exponential dimming curve. The dimming curve itself is derived as a mathematical power function.

### **JUNG**

This dimming curve is a mixture of the three linear, exponential and potential dimming curves mentioned so far. It can be dimmed very far in the lower range and is adjusted as evenly as possible to the sensation of the eye in all other ranges. This curve has been specially adapted at JUNG to the dimming behavior of the device and connected LEDs and is highly recommended in residential areas.

### **General note:**

For single channel operation the curve "JUNG" is recommended, because here a steady brightness increase/decrease for the eye has been implemented. For RGB and TW channel groups, on the other hand, the linear dimming curve is recommended if the colors or color temperatures are to be changed frequently and value is placed on color-true reproduction. If this is not the case, the "JUNG" curve is also considered to be the more beautiful (more uniform). Depending on the illuminant and the selected dimming curve, it can happen that this only switches on the LEDs from 3% brightness control. To make this comfortable for the user in such situations, a "restriction" of the dimming range can be defined for the dimming channel.

## 7.2. Dimming behavior

In addition to the effects mentioned for human perception, which result from this splitting of the dimming curves into 255 individual points, an important unique selling point of the device is the "soft" dimming during the transition from a certain starting point to an end point.

Due to a special control of the dimmer, no step, i.e. sudden change in brightness of the illuminants is perceptible even during slow dimming and dimming is continuous at all times

With short dimming times over a larger range, this control ensures that no flickering occurs for the human eye.

Even in the lowest brightness range (<5%), the control releases continuous dimming of the illuminants, so that for the human eye, the LEDs are switched off or on without a noticeable jump in brightness.

With the dimmer, flickering is avoided regardless of the choice of dimming curve; the transitions are always smooth or appear jerk-free.

## 7.3. Limit dimming range

The dimming ranges can be restricted. The options Restrict and Spread are available for the single channel and Tunable White operating modes, and minimum and maximum values can be parameterized. In RGB operating mode, only maximum values can be specified and it always follows the principle of spreading (=scaling).

An absolute dimming value of 0 leads to switching off in every parameterization.

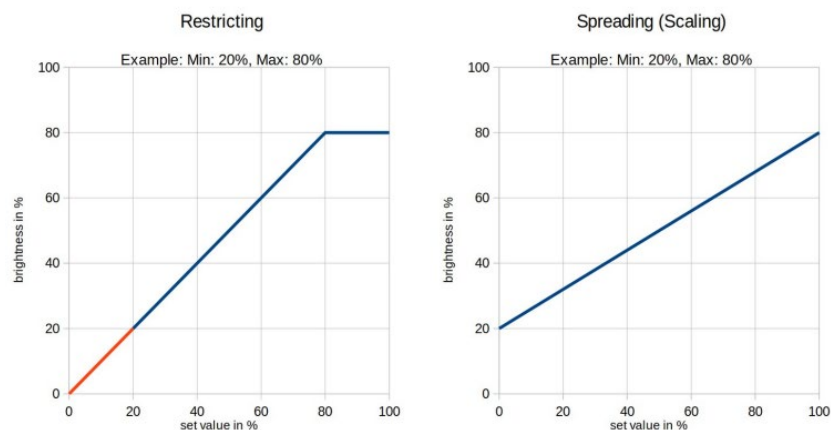

Figure 12: Limit dimming range – Comparison

## 7.4. Measurements and counters

### 7.4.1. Measurements

The device has integrated measuring circuits for current, voltage, temperature and telegram rate and can show these measured values on the display and, if desired, also make them available via CO. All measured values can be sent to the bus cyclically and/or on change. For the value output of current, voltage and temperature values, different KNX data types are also available in each case.

Line losses: In order to be able to calculate the voltage at the illuminant using the internally measured voltage at the channel, the cable length and cross-section must be parameterized in the application in the "Measurements and counters" tab, as well as whether the channels have a common return line, which is often the case with RGB illuminants, for example.

Note: This information about the conductors is also mandatory for a correct function of the lamp protection (see chapter Alarm objects and protection functions)

### 7.4.2. Counter

The integrated energy meter counts the energy consumed on the mains side, based on a (parameterizable) average efficiency of the upstream LED power supply. The energy meter also becomes a cost meter by means of a parameterizable electricity price. Both meters can be used as a totalizer and/or per channel/channel group.

## 7.5. Alarm objects and protection functions

The device provides various 1-bit alarm objects that indicate the activity of the integrated protection circuits for undervoltage (power supply voltage), overtemperature and overcurrent (channel-specific). The thresholds for triggering these protective shutdowns are "cast in hardware" and cannot be parameterized. The protective shutdowns are self-healing, i.e. as soon as the cause of the fault is eliminated, the channels are switched on again

### 7.5.1. Illuminant protection

Some illuminants that combine several channels (such as Tunable White (TW), RGB, RGBW, RGBCCT) are designed in such a way that the illuminant is thermally overloaded when all channels are fully controlled at the same time.

The device offers a parameterizable protection function that protects the illuminants from thermal overload.

For the activation and the correct function of the illuminant protection, information about the (thermal) continuous power, overload capacity (in %) and the maximum duration of the overload must be provided. In addition, a correct voltage measurement is a prerequisite, which in turn is only possible if the entries for the lines have been made completely.

Separate 1-bit alarm objects are available for exceeding

- the continuous power
- the I<sup>2</sup>t value
- the maximum power

Optionally, a shutdown can be parameterized for the various overload scenarios. In contrast to the integrated dimmer protection functions, the illuminant protection shutdown is not self-resetting, i.e. as soon as the cause of the error is eliminated, the channels must be switched on again manually.

**Example:**

- Illuminant: Tunable White
- Continuous power (sum of both channels): 20 W
- Overload capacity: 50 %
- Maximum duration overload: 60 s
  - Trigger of the alarm objects or (if parameterized) of the shutdown
  - CO Continuous power when exceeding a power of 20 W
  - CO-Maximum power when exceeding a power of 30 W
    - CO I<sup>2</sup>t when exceeding a power of 20 W for more than 60 s or (according to equation 1) of, for example
      - o 25 W for more than 48 s, or
      - o 35 W for more than 34 s, or
      - o 100 W for more than 12 s

$$Time[s] = \frac{ContinuusPower[W] * MaximumOverLoadTime[s]}{MeasuredPower [W]}$$

### 7.5.2. Power supply protection

Analogous to the lamp protection, the dimming sequencer can also protect the upstream LED power supply from overload. For this purpose, specifications must also be made for the continuous power, the overload capacity (in %) and the maximum duration of the overload. Separate 1-bit alarm objects are available for the exceeding of

- the continuous power
- the  $I^2t$  – value
- the maximum power

Optionally, a shutdown can be parameterized for the various overload scenarios. Like the illuminant protection shutdown, the power supply protection shutdown is not self-resetting, i.e. as soon as the cause of the fault has been eliminated, the channels must be switched on again manually.

The Enertex® LED PowerSupply 160 has an integrated overload protection that throttles the output power to 160W. So, for this power supply, the protection function is not needed at all.

#### Example:

- Continuous power: 100 W
- Overload capability: 50 %
- Maximum duration overload: 600 s (10 min)
  - Trigger of the alarm objects or (if parameterized) of the shutdown
  - CO Continuous power when exceeding a power of 100 W
  - CO Maximum power when exceeding a power of 150 W
  - CO  $I^2t$  if a power of 100 W is exceeded for more than 600 s or (also according to equation 1) of, for example
    - 120 W for more than 500 s (~ 8,3 min), or
    - 180 W for more than 333 s (~ 5,6 min), or
    - 200 W for more than 300 s (~ 5 min)

#### Explanation for $I^2t$ shutdown

Illuminant and power supply disconnections can be parameterized in such a way that they come close to the behavior of a fuse. These generally function in such a way that the switch-off occurs as soon as the nominal current is exceeded by a certain amount for a sufficient time. The higher the current, the faster the disconnection.

With reference to the protective functions of the device, we are specifically concerned here with the powers between the parameterized continuous power (powers below this are never switched off) and the maximum power (powers above this are switched off immediately). The powers in between (in Fig. 7 these would be values between 100 and 200 W) are switched off depending on the amount of power after a time of 500 s (at 200 W) to 1000 s (at 100 W).

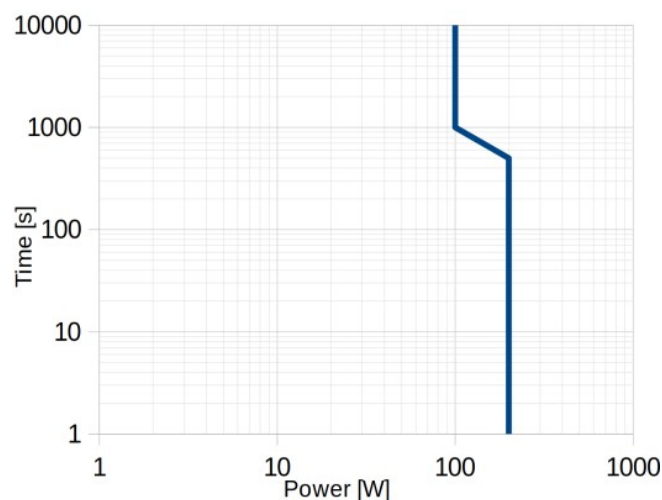

Figure 13:  $I^2t$ -shutdown

## 7.6. Channel functions

### 7.6.1. RGB

The application of the device offers the possibility to control specific colors by means of special RGB parameters and a "Colour-Picker" displayed directly in the ETS (see Fig. 8). In addition, various communication objects are available with which the color channels can be addressed individually or together.

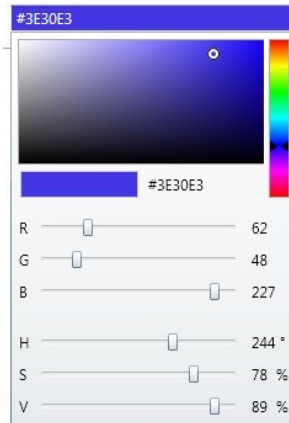

Figure 14: ETS Colour-Picker

For illuminants that have one (RGBW) or two (RGBCCT) white channels integrated, additional functions are available (see corresponding subchapter RGBW or RGBCCT: Extended-RGB).

## 7.6.2. RGBCCT: Extended-RGB

### Automatic white balance

An RGBCCT (R-G-B-Correlated-Color-Temperature) illuminant combines red, green, blue, cool white and warm white LEDs in one illuminant. The application allows the two white channels to be automatically mixed in when the saturation of a color value is lowered. This results in a "nicer" white tone than the white tone mixed by the RGB colors. JUNG was the first to introduce this mode to the market in the present generation of devices and calls it "Extended RGB".

The calculation of the color spaces and the white channel admixture is done internally in the device and does not have to be parameterized by the user. Only the desired color temperature of the white LEDs must be specified. The color mixing can be influenced via dimming curves and, if necessary, brightness limits. However, this is not recommended in normal cases since the JUNG algorithm already achieves optimal results.

### Standard Mode

If this automatic mixing is not desired, the brightness can also be parameterized separately or also adjusted during runtime by means of CO.

### Example:

- Initial value: Pure blue with 100% saturation and brightness
- New value: Saturation reduced to 50%
  - In the normal RGB application or when automatic mixing is deactivated, saturation reduction is achieved by mixing the R and G channels by 50% each
  - In Extended-RGB mode, the white channels are additionally mixed in to reduce saturation

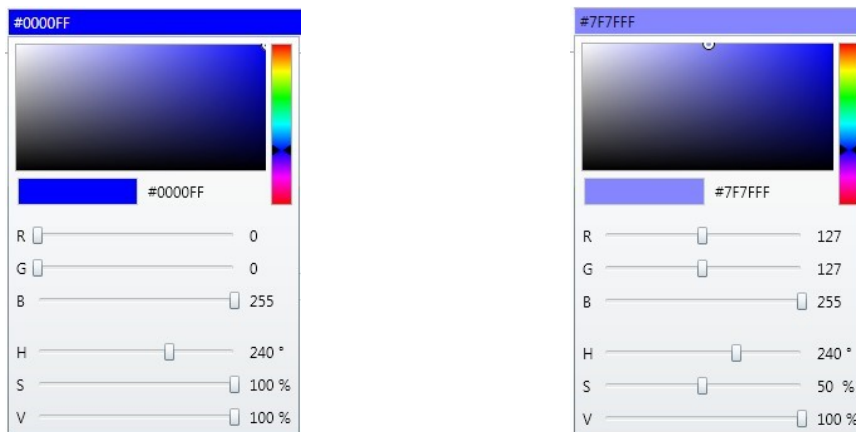

Figure 15: Initial – New Value

A Default value of

- R: 127
- G: 127
- B: 255

Or

- H: 240 °
- S: 50 %
- V: 100 %

thus leads, in addition to the corresponding control of the R/G/B channels, to the admixture of the Tunable White channel with intensity 50% (0% saturation would lead to 100% TW brightness).



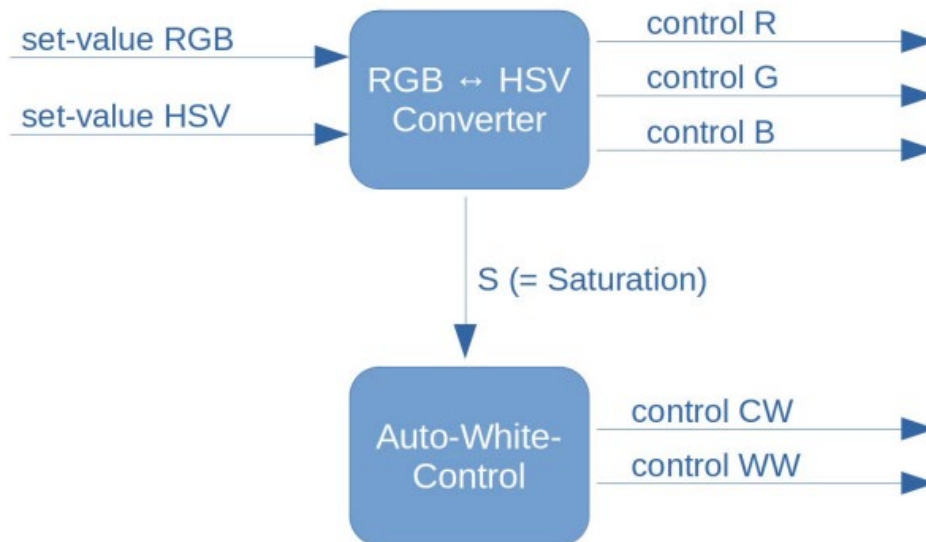

Figure 16: Automatic white balance „Extended RGB“

The mixing ratio of the two white channels can also be parameterized either as "Fix" or separately for the individual application scenarios or also adjusted by means of CO

### 7.6.3. RGBW

#### Automatic white balance

An RGBW illuminant combines red, green, blue and white LEDs in one illuminant. The RGBW application allows the white channel to be automatically mixed in when the saturation of a color value is lowered (analogous to RGB CCT: Extended-RGB, with only one white channel). This results in a "nicer" white tone than the white tone mixed by the RGB colors. JUNG was the first to introduce this mode to the market in the present generation of devices and calls this "Extended RGB".

The calculation of the color spaces and the white channel admixture is done internally in the device and does not have to be parameterized by the user. Only the color temperature of the white LED must be specified. The color mixing can be influenced via dimming curves and, if necessary, brightness limits. However, this is not recommended in normal cases, as the JUNG algorithm already achieves optimal results

#### Standard mode

If this automatic mixing is not desired, the brightness can also be parameterized separately or also adjusted during runtime by means of CO.

#### 7.6.4. Color spaces RGB and HSV

The device offers the possibility to set the color control via RGB objects or HSV objects. In addition, the dimmer calculates the other state objects in each case and outputs them to the bus according to the parameterization.

Technically the RGB - LED illuminants are composed of the three colors red-green-blue. Therefore, the control via an RGB object, which outputs an intensity from 0 to 100% for each of the three colors, is technically easy to realize. The resulting light color is composed of the three color channels, but it is considerably more complex for the user to set a color value CYAN, for example. This is different when using HSV objects. Here the H - value (color angle) specifies the color tone. This is given as a so-called color angle, which corresponds to a color in the color wheel. Each angle value means a different color, e.g. 0° for red, 30° for orange, 60° for yellow and so on. The color transitions are fluent.



Bildquelle: [Wikipedia](#); gemeinfrei.

Figure 17: HSV

The S - value (saturation) indicates the color saturation. S = 0% means white light and S = 100% complete lighting only in the set color tone. "White" is to be understood in the context of the possibilities of the illuminant, because white light is only created by mixing the three colors (see section White balance). However, this white light is not always pleasant or sufficiently white for human perception, so RGBW illuminants offer an additional white LED channel that is adjusted to an appropriate white light by the manufacturer. When working with RGBW illuminants, this additional white channel is available in the application and can also be specified in the sequence. The saturation value S is not directly influenced by the white channel, the two values S and white channel are to be considered separately.

The V- value (brightness value) specifies the brightness of the lighting. 0% means OFF and 100% maximum brightness.

##### **Limit dimming range**

The white light is provided by mixing the control of the individual color channels. Depending on the LED illuminant, the resulting white light may not be considered optimal by the user, so that an adjustment of the white light must be made. The device can be used to define the mixing ratio of the three individual channels.

If you set the white balance (CO) to ON via telegram, you specify the setting via the RGB or HSV values which best matches the desired white light at maximum brightness. Then set the object to OFF. Then the values are stored. If, for example, the illuminant has a blue component that is a little too high for a pleasant white light, R=100%, G=100%, B=80% will be determined during the white balance. After ending the white balance, the dimmer is controlled relative to this, i.e. the blue component from 0 to 80% is scaled to the value range 0 to 100%.

Note: This scaling is retained when the device is restarted and the application is downloaded from the ETS. It can only be overwritten by a new white balance.

Alternatively, these maximum values can also be defined by means of parameters.

### 7.6.5. Color temperature control

#### Tunable White

A Tunable White illuminant consists of white LEDs of two different color temperatures - a cool white and a warm white tone.

By allocating two channels (a TW channel pair) of the device, it can take over the control of brightness and color temperature of the illuminant.

The mixing ratio of the two channels can be permanently parameterized for different application scenarios but can also be changed at runtime by means of group addresses. The mixing ratio is specified as "% cold white" by default but can also be specified directly in Kelvin instead if the color temperatures of the two white channels (cold and warm white) are made known / parameterized to the application accordingly. The latter could be advantageous, for example, if different tunable white illuminants are used in a room and an adjustment of the color temperatures is to be undertaken.

The warm white light color (2000 to 3300 K) is often perceived by people as pleasantly calming. The cold white light color (from 6000 K) describes a white color spectrum with an increased blue component. This increased blue component causes the observer to be in a heightened state of alertness. Therefore, it can be advantageous, e.g. in office rooms, to increase the cold white portion in the morning and the warm white portion in the evening. By means of a timecontrolled sequence, a course of the day with its different color temperatures can be easily mapped (cf. chapter Time-controlled dimming and Human Centric Light (HCL)).

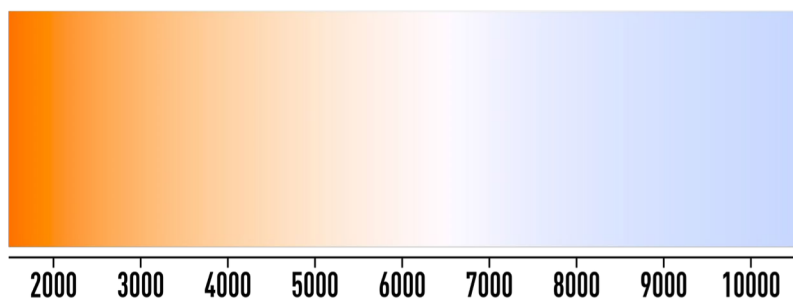

Figure 18: Color temperature in Kelvin

#### RGBCCT: Extended-TW

An RGBCCT (R-G-B-Correlated-Color-Temperature) illuminant combines red, green, blue, cool white and warm white LEDs in one illuminant. The "Extended-TW" application allows to extend the color temperature range of the Tunable White channel by automatically mixing color channels R, G and B in both directions. In addition to the temperature values of the two white channels cool white and warm white, the extended limits (also in Kelvin) must be specified. JUNG was the first to introduce this mode in the present generation of devices on the market and calls this "Extended TW". The user does not have to make any complex calculations here or carry out tests with the individual illuminants. Only the light temperature of the white LEDs must be specified. The JUNG algorithm automatically determines the optimal control. To allow additional color control, the COs for RGB control are also visible in this mode.

**Example:**

- Parameterization:
  - Color temperature illuminant warm white: 2700 K
  - Color temperature illuminant cold white: 6000 K
  - Minimum value: 1000 K
  - Maximum value: 10000 K
- Without TW-Extended, color temperatures between 2700 and 6000 K can be achieved by mixing the two white channels.
  - With TW-Extended - by mixing the three color channels - the warm white range is extended up to 1000 K and the cool white range up to 10000 K.
  - Note: The %-coldwhite parameters or CO then also no longer refer only to the white channels, but to the extended limits, e.g.:
    - 0% CW → 1000 K
    - 100% CW → 10000 K

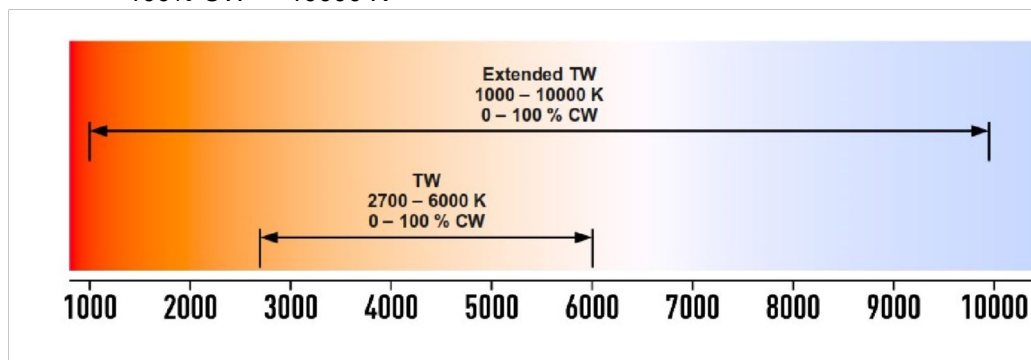

Figure 19: Example Extended-TW

**RGBW: Virtualized TW**

A Tunable White application can also be realized with a 4-channel RGBW illuminant (Simulated Tunable White). By mixing the color channels (red/green in the direction of warm white and blue/green in the direction of cool white) with the actual white tone of the white LED, significant shifts in the color temperature can be realized. Analog to the Extended-TW with RGB CCT illuminants, the color temperature of the white LED as well as the maximum color temperatures must be specified in the parameter set.

The user does not have to make complex calculations or carry out tests with the individual illuminants. The JUNG algorithm independently determines the optimal control. To additionally allow color control, the COs for RGB control are also visible in this mode.

**Example:**

- Parameterization:
  - Color temperature illuminant white: 5000 K
  - Minimum value: 1000 K
  - Maximum value: 10000 K
- With activated Virt-TW, a Tunable White is now realized internally by mixing color.
- Note: The %-cold white parameters or CO then also refer to the extended limits, e.g.:
  - 0% CW → 1000 K
  - 100% CW → 10000 K

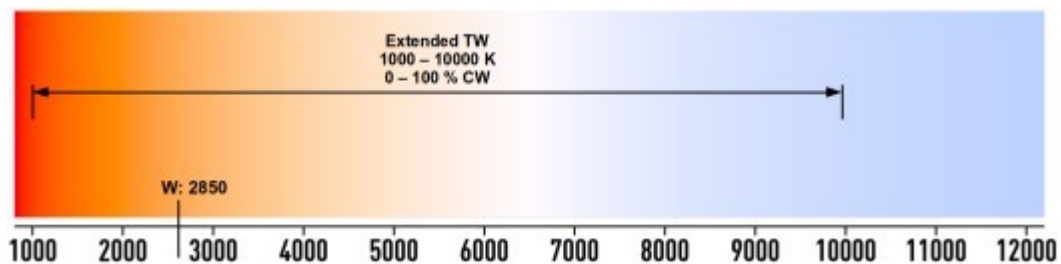

Figure 20: Example Virtualized TW

**RGB: Virtualized TW**

The implementation of a Tunable White simulation for a 3-channel RGB illuminant was deliberately omitted. The color intensities of individual illuminants are so different that a simple parameter set as in the RGBW: Virtualized TW is not purposeful, or only unsatisfactory results can be achieved depending on the illuminant.

**Dim-2-Warm**

This functionality can be used to simulate the dimming behavior of earlier halogen illuminants whose color temperature shifts towards warm white as the brightness decreases. For this purpose, two points are defined, each with brightness and color temperature.

**Example:**

|                          | Brightness | Color Temperature |
|--------------------------|------------|-------------------|
| <b>Threshold value 1</b> | 10 %       | 2500 K            |
| <b>Threshold value 2</b> | 60 %       | 4000 K            |

*Table 3: Example Dim-2-Warm*

Result:

- Total brightness of 10 % and less → Color temperature 2500 K
  - Total brightness between 10 and 60 % → Linear interpolation of color temperature between 2500 and 4000 K
  - Total brightness greater than 60 % → Color temperature 4000 K
- If Dim-2-Warm is activated, the color temperature cannot be adjusted otherwise by means of parameters or COs.

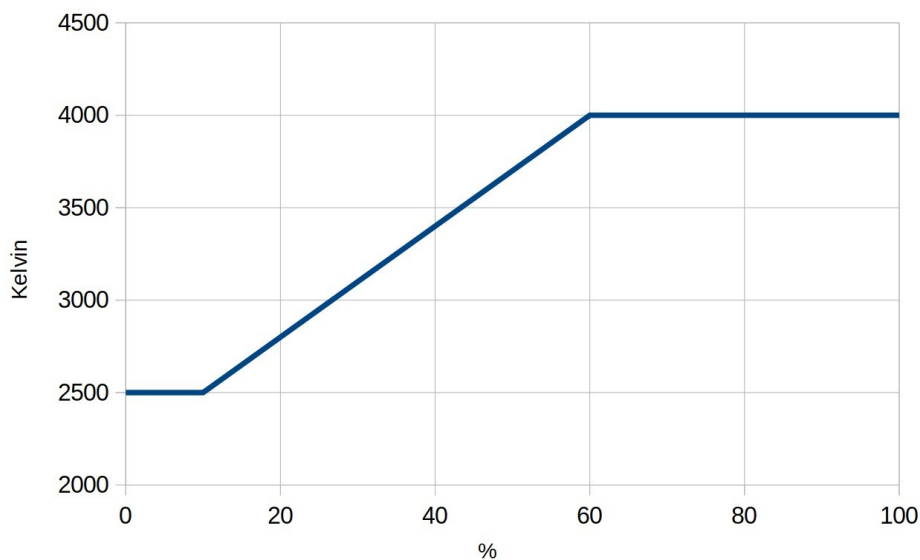

*Figure 21: Example Dim-2-Warm*

### 7.6.6. Time-controlled dimming and Human Centric Light (HCL)

Via integrated timers, it is possible to run through sequences that are dependent on the time of day. These times, which are accompanied by changes in brightness or color value, can be parameterized as fixed times or relative to sunrise or sunset. A mixture of fixed and relative times is also possible. Up to ten time points with associated brightness or color values can be parameterized. The parameterized time points do not have to be chronological. They are automatically put into the correct order daily at 00:00 after calculation of the sunrise and sunset for the day.

Human Centric Light (HCL) describes time-controlled dimming in the Tunable White operating mode. This is less about changing the overall brightness and more about shifting the color temperature within the specified spectrum.

The following figure shows typical starting points for an HCL cycle: The day begins in the morning hours with a very warm light similar to sunrise, before the color temperature increases more and more in the course of the morning, i.e. it becomes colder. In the midday hours, the light (as well as the sun at its zenith) is at its coldest. In the course of the afternoon, the temperature decreases again, i.e. becomes warmer, and culminates in its warmest point with the sunset.

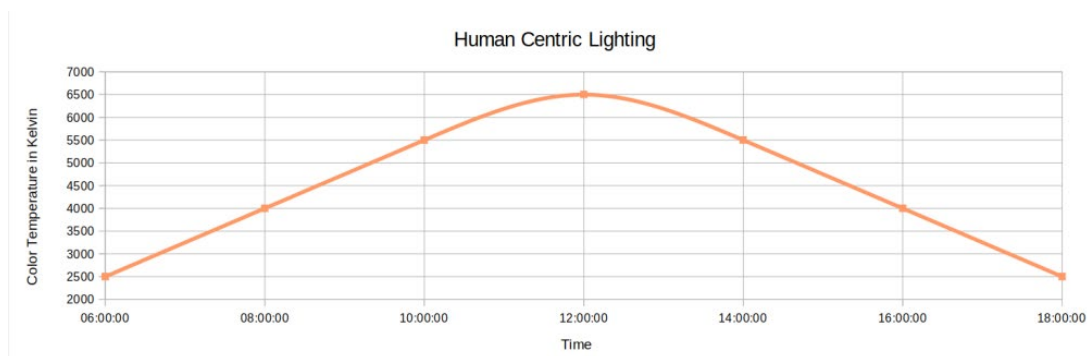

Figure 22: Human Centric Lighting

## 8. ETS Application

### 8.1. Specification

ETS: from Version 5.7.4

### 8.2. Parameter

Note: Depending on the parameterization, some setting options may not be available. In these cases, they are not displayed in the ETS.

#### 8.2.1. General

Channel configuration

Function

Extension  RGB-Extended  TW-Extended

Note: With RGB-Extended it is possible to activate automatic white control. This automatically activates the CCT channels when color saturation is low.

|     | RGBCCT                              |
|-----|-------------------------------------|
| Use | <input checked="" type="checkbox"/> |

Figure 23: General

| Parameter | Selection  | Description  |
|-----------|--|--|
| Function  | 5x Single channel (EK)<br>1x RGBCCT<br>1x RGBW + 1x EK<br>1x RGB + 2x EK<br>1x RGB + 1x TW<br>2x TW + 1x EK<br>1x TW + 3x EK | Determination of the operating mode: <ul style="list-style-type: none"> <li>• RGB: Red/Green/Blue</li> <li>• RGBW: Red/Green/Blue/White</li> <li>• RGBCCT: Red/Green/Blue/Cold White/Warm White</li> <li>• TW: Tunable White: Cold White + Warm White</li> </ul>   |
| Extension | RGB-Extended<br>TW-Extended  | Restriction: The parameter is only available if <ul style="list-style-type: none"> <li>• Operating Mode: 1x RGBCCT</li> </ul> Specifying the type of extension for RGBCCT: <ul style="list-style-type: none"> <li>• RGB Extended: RGB operation mode where white can be automatically mixed in.</li> <li>• TW-Extended: TW operating mode in which the warm white and cool white limits can be extended by mixing in the corresponding color. Further explanations of the two extensions can be found in the chapters RGBCCT: Extended-RGB or RGBCCT: Extended-TW</li> </ul> |
| Use       | Checkbox   | Release of the channel / channel group   |

Table 4: Parameter General



### 8.2.1.1. Configuration

#### General settings

Note: A general parameter is valid for all channels / channel groups. For some parameters, it is possible to specify whether they are to be defined for all channels or channel- / channel group-specific.

PWM frequency 488 Hz ▾

Note: In general, lower PWM frequencies are recommended to achieve the lowest possible minimum brightness. Higher frequencies can be used if, for example, flickering can be detected at lower frequencies.

Behaviour at bus voltage return  All channels identical  
 Each channel individual  
Values before bus voltage failure ▾

Switch-on delay All channels identical ▾  
0 ▾ s

Switch-off delay All channels identical ▾  
0 ▾ s

Status output behaviour  All channels identical  
 Each channel individual  
At the end of the dimming process ▾

Cyclical status output  All channels identical  
 Each channel individual  
Off ▾

Telegram rate limit (Tx) 50 ▾ T / s

Enable external power relay?  No  Yes

Table 5: Configuration

| Parameter                        | Selection   | Description   |
|----------------------------------|---|---|
| PWM Frequency                    | 211 Hz<br>488 Hz<br>600 Hz<br>832 Hz<br>1000 Hz<br>1200 Hz  | Determination of the PWM frequency. This applies to all channels.<br>Recommendation: 488 Hz<br>Note: Generally lower PWM frequencies are recommended to be able to dim down as far as possible. Higher frequencies can be used if flickering can be detected at the lower frequencies.  |
| Behavior on bus voltage recovery | All channels identical<br>Each channel individual<br><br>Illuminant Off<br>Last value<br>Fixed value  | Determines whether the behavior on bus voltage recovery is to be defined globally or channel/channel group-specifically.<br><br>If All channels identical:<br>Illuminant Off: All channels are off<br>Last value: Each channel dims to the brightness value it had before bus voltage failure<br>Fixed value: All channels dim to one parameterizable brightness value  |
| Brightness of all channels       | 0 – 100 %   | Restriction: The parameter is only available if <ul style="list-style-type: none"> <li>Behavior on bus voltage recovery: Global and Fixed value</li> </ul> Switch-on brightness after bus voltage recovery  |
| Switch-on delay                  | All channels identical<br>All channels identical with day / night Distinction<br>Each channel individual<br>Each channel individual with day / night distinction  | Definition of whether the switch-on delay (switch-on by means of switch object) is to be defined globally or channel/channel group-specifically. In both cases, it is also possible to determine whether there should be a distinction between day and night.   |
| Switch-on delay                  | 0 – 60 s  | Restriction: The parameter is only available if <ul style="list-style-type: none"> <li>Switch-on delay: Identical</li> </ul> Definition of the switch-on delay in seconds, independent of the time of day.  |
| Switch-on delay day              | 0 – 60 s  | Restriction: The parameter is only available if <ul style="list-style-type: none"> <li>Switch-on delay: All channels identical with day / night Distinction</li> </ul> Definition of the switch-on delay for day in seconds   |
| Switch-on delay night            | 0 – 60 s  |   |
| Switch-off delay                 | Analog to switch-on delay   | Analog to switch-on delay   |
| Behavior status output           | All channels identical<br>Each channel individual<br><br>At the end of the dimming process<br><br>During the dimming process in defined % steps + At the end<br><br>During dimming in defined time steps + At the end | Determines whether the behavior on bus voltage recovery is to be defined globally or channel/channel group-specifically.<br><br>If All channels identical:<br>All relevant status objects are output at the end of the dimming process<br><br>During the dimming process in defined % steps + At the end: All relevant status objects are output at the end of the dimming process and also in parameterizable percentage steps during the dimming process<br><br>During the dimming process in defined time steps + At the end: All relevant status objects are output at the end of the dimming process and in parameterizable time steps during the dimming process. |
| Status output all                | 5 %<br>10 %<br>20 %<br>50 %<br>or.<br>1 – 60 s  | Restriction: The parameter is only available if <ul style="list-style-type: none"> <li>Behavior Status output: During the dimming process in defined % steps or At the end or During the dimming process in defined time steps + At the end</li> </ul> Defining the step size of the status outputs during the dimming process  |

|                               |  |   |
|-------------------------------|--|---|
| Cyclic status output          | All channels identical<br>Each channel individual<br><br>off<br>1 min<br>5 min<br>10 min<br>30 min<br>60 min | Definition of whether the behavior Cyclic status outputs (regardless of whether a dimming process is currently running or not) is to be set globally or channel/channel group-specifically.<br><br>If All channels identical:<br><br>Selection of the step size for the cyclical status output of all relevant status objects |
| Telegram rate limitation (Tx) | 5 – 50 Telegrams / s   | Limitation of the transmission power of the device in order not to overload the bus load during status outputs in projects with a high base load. Telegrams that cannot be sent immediately due to the limitation are buffered and successively written to the bus.   |
| Release external mains relay  | Yes<br>No  | Enabling of the external switching actuator to switch off the LED power supply on the mains side when there is no demand  |

*Table 6: Configuration*

### 8.2.1.2. Dimming settings

#### General settings

Note: A general parameter is valid for all channels / channel groups. For some parameters, it is possible to specify whether they are to be defined for all channels or channel- / channel group-specific.

Dimming characteristics  All channels identical  
 Each channel individual

Linear (A) ▾

For single channel, the "JUNG" characteristic is recommended, as a continuously increasing / decreasing brightness perceived by the human eye has been implemented. For RGB and TW, on the other hand, the linear dimming characteristic is recommended.

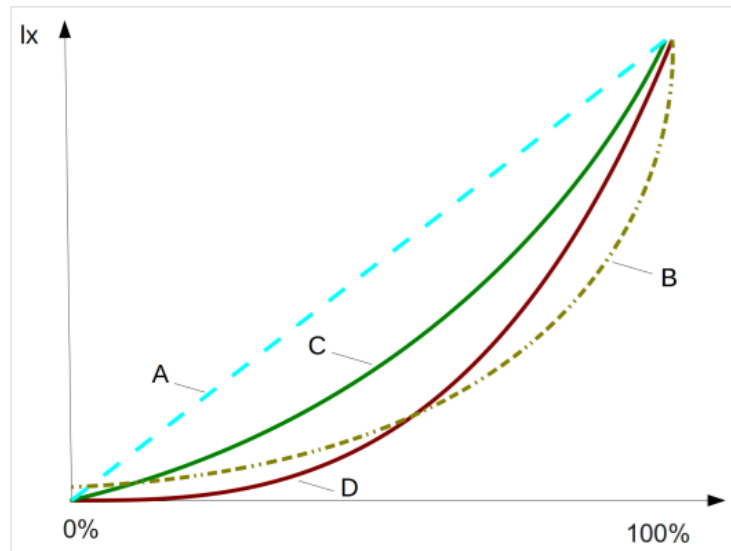

Switch when dimming  All channels identical  
 Each channel individual

No  Yes

---

Definition of dimming speed absolute Time per dimming process

Definition of dimming speed relative Time per dimming process

Dimming speeds All channels identical ▾

Dimming speed absolute 3 s

Dimming speed relative 3 s

Switch-on speed 3 s

Switch-off speed 3 s

Figure 24: Dimming settings

| Parameter                  | Selection  | Description   |
|----------------------------|--|---|
| Dimming curve              | All channels identical<br>Each channel individual<br><br>Linear (A)<br>Exponential (B)<br>Power function (C)<br>JUNG (D)                                   | Definition of whether the dimming curve is to be set globally or channel/channel group-specifically.<br><br>If All channels identical:<br>Selection of the dimming curve (see also Dimming curve)<br><br>Note: For single channel operation, the "JUNG" curve is recommended, as a continuous brightness increase/decrease is implemented for the eye. For RGB and TW channel groups, on the other hand, the linear dimming curve is recommended.   |
| Switching during dimming   | All channels identical<br>Each channel individual<br><br>Yes<br>No   | Definition of whether the behavior Switch on dimming is to be defined for all channels or for specific channels/channel groups.<br><br>If All channels identical:<br>Definition of whether a relative dimming command may also be used to switch on.<br>Note: Internally, staircase lighting, scenes, bit scenes, disable functions, sequences and time-controlled dimming are also treated as absolute dimming operations. Therefore, when using these functions, it is recommended to set the parameter to "Yes" in any case, if the switch object is not to be switched on first before each action. |
| Dimming speed Absolute day | Time per dimming operation Time from 0 → 100   | Restriction: The parameter is only available, if <ul style="list-style-type: none"> <li>General/Function no RGB(CCT/W) channel group contains</li> </ul> Definition of whether the absolute / relative dimming speeds parameterized in the further course refer to the individual dimming process (independent of the step width) or always to the step 0 → 100 % and are then scaled accordingly.  |
| Dimming speed Relative day | Time per dimming operation Time from 0 → 100   | For RGB(CCT/W) channel groups, only the former is available.<br>For TW channel groups both definitions are available, but it is also recommended to use the former.   |
| Dimming speed              | All channels identical<br>All channels identical [day / night distinction]<br>Each channel individual<br>Each channel individual [day / night distinction] | Definition of whether the dimming speeds (switching on by means of a switch object) are to be defined on a cross-channel or channel/channel group-specific basis. In both cases, it is also possible to specify whether there should be a distinction between day and night.  |
| Dimming speed Absolute day | 0 – 60 s   | Restriction: The parameter is only available if <ul style="list-style-type: none"> <li>Dimming speeds: identical with distinction day / night</li> </ul>  |
| Dimming speed Relative day | 0 – 60 s   | Definition of dimming speed for absolute / relative dimming processes in seconds during the day   |
| Switch on speed day        | 0 – 60 s   | Restriction: The parameter is only available if <ul style="list-style-type: none"> <li>Dimming speeds: identical with distinction day / night</li> </ul> Definition of the dimming speed for switch-off processes in seconds during the day. The value refers to the process of 100 → 0 %. For lower output brightness, the time is scaled accordingly  |

|                             |   |  |
|-----------------------------|---|--|
| Switch off speed            | 0 – 60 s                                | <p>Restriction: The parameter is only available if</p> <ul style="list-style-type: none"> <li>Dimming speeds: identical with distinction day / night</li> </ul> <p>Definition of the dimming speed for switch-off processes in seconds during the day. The value refers to the process of 100 → 0 %. For lower output brightness, the time is scaled accordingly</p> |
| Dimming speed Absolute nigh | Analogous to dimming speed Absolute day | Analogous to dimming speed Absolute day  |
| Dimming speed relative nigh | Analogous to dimming speed relative day | Analogous to dimming speed relative day  |
| Switch on speed night       | Analogous to switch-on speed Day        | Analogous to switch-on speed Day   |
| Switch off speed night      | Analogous to switch-off speed Day       | Analogous to switch-off speed Day  |

Table 7: Parameter dimming settings

### 8.2.1.3. Time functions

#### Day / night switching

Note: Day / night switching can be done by means of a 1-bit communication object. Alternatively, it can be done automatically based on sunrise / sunset calculations if the time and date have been set via a communication object.

Note: After a restart, the internal day / night status is invalid until the corresponding communication objects have been written. Until then, the parameterisations for "Day" are active.

- Day / night switching with  Communication object  
 Internal timer switch (sunrise / sunset)
- Polarity day / night  Day (0) / Night (1) [KNX DPT standard]  
 Day (1) / Night (0)

#### Timer switch

Note: If the timer switch objects are enabled, the time and date must be set by means of a communication object after the device start for proper function.

- Enable timer switch objects (required for all time functions)?  No  Yes
- Request timer switch objects at bus voltage return  No  Yes

Note: For the sunrise / sunset calculations, the following information about the location is required.

- Set the location:  City selection  Coordinates

City selection

- Automatic switching between summer and winter time  No  Yes

Figure 25: time functions

### 8.2.1.4. External power relay

Note: This tab is only available if parameter "Release external power relay" under General/Configuration is set to Yes.

#### External power relay

Note: To minimise standby losses, the device offers the option of switching the LED power supply by means of an external switching contact on the power supply. Due to the start-up time of the power supply, the dimming process can be started with a delay.

Optimised start of the dimming process at  V

Switch-off delay  min

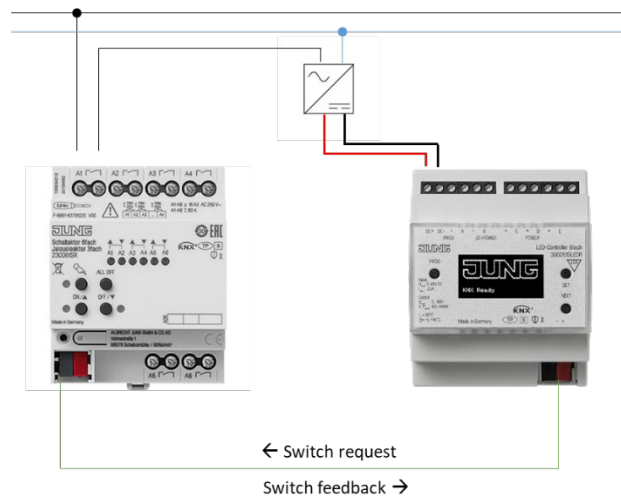

Figure 26: Parameter 8.2.1.4 External power relay

| Parameter                                     | Selection                                  | Description  |
|---|--|--|
| Optimized start of dimming at                 | 4 – 48 V                                   | The switch-on process only starts when the threshold voltage parameterized here is reached after switching on the LED power supply. Recommendation: The value should be 1 to 2 V below the nominal voltage.  |
| Switch-off delay                              | 0 – 180 min                                | To avoid too frequent switch-off processes of the LED power supply in certain scenarios, a switch-off delay can be parameterized here.   |
| Day / night switching by                      | CO<br>Internal Timer                       | Release communication object day/night.<br>This parameter defines whether the day/night switchover is to be performed externally by means of CO or on the basis of an internally calculated sunrise/sunset (only possible if time/date is set by means of CO). |
| Polarity day / night                          | day (0) / night (1)<br>day (1) / night (0) | Restriction: The parameter is only available if <ul style="list-style-type: none"> <li>Day / night changeover by means of: CO</li> </ul> Depending on the parameterization polarity day is set for value 0 (KNX DPT standard) or for value 1.                  |
| Release time objects?                         | Yes<br>No                                  | Release of the communication objects Time and Date.<br>This release is a prerequisite for the use of time-controlled dimming.  |
| Request timer objects on bus voltage recovery | Yes<br>No                                  | Restriction: The parameter is only available if <ul style="list-style-type: none"> <li>Release time objects: Yes</li> </ul>  |
| Set location                                  | City selection<br>Coordinates              | If Yes, time and date objects are automatically requested after device start<br>If Yes, Location selection for sunrise/sunset calculation  |



|  |                 |  |
|--|-----------------|--|
| City selection                                     | Div. City       | Selecting the city or entering the coordinates   |
| Longitude East                                     | -180 - +180 °   |  |
| Latitude North                                     | -90 - +90 °     |  |
| Time zone with regard to world time (UTC)          | Div. Time zones | <p>Restriction: The parameter is only available if</p> <ul style="list-style-type: none"> <li>• Release time objects: Yes</li> <li>• Set location: Coordinates</li> </ul> <p>Set time zone against UTC</p>               |
| Automatic switching between summer and winter time | Yes<br>No       | <p>Restriction: The parameter is only available if</p> <ul style="list-style-type: none"> <li>• Release time objects: Yes</li> </ul> <p>Defines whether an automatic summer/winter time changeover is to take place.</p> |

*Table 8: time functions*

### 8.2.2. Measurements and meter

Note: This tab is always available.

The information about the line is necessary for the calculation of the voltage drop at the conductor and thus for the voltage measurement at the illuminant (commissioning function), as well as for the illuminant protection functions. If these functions are not used, the parameters can be ignored.

#### Necessary information

**i** The following information about the cables is necessary for voltage measurement (at the lamp), as well as for the lamp protection functions (see the "Protection functions and alarms" menu).

|                | Cable length |          | Cable cross-section               |   | Return via channel |
|----------------|--------------|----------|-----------------------------------|---|--------------------|
| Channel A (R)  | 18,6         | ▲<br>▼ m | 1.5 mm <sup>2</sup> (AWG 15 - 16) | ▼ | A ▼                |
| Channel B (G)  | 18,6         | ▲<br>▼ m | 1.5 mm <sup>2</sup> (AWG 15 - 16) | ▼ | A ▼                |
| Channel C (B)  | 18,6         | ▲<br>▼ m | 1.5 mm <sup>2</sup> (AWG 15 - 16) | ▼ | A ▼                |
| Channel D (KW) | 18,6         | ▲<br>▼ m | 1.5 mm <sup>2</sup> (AWG 15 - 16) | ▼ | A ▼                |
| Channel E (WW) | 18,6         | ▲<br>▼ m | 1.5 mm <sup>2</sup> (AWG 15 - 16) | ▼ | A ▼                |

#### Enabled

Enable measurements?  No  Yes

Enable meter?  No  Yes

Figure 27: Measurements and counters

| Parameter              | Selection   | Description   |
|------------------------|---|---|
| Cable length           | 0,5 – 50 m  | Parameterization of the cable length (single) in meters   |
| Conductor crosssection | 0,75 mm <sup>2</sup><br>1,5 mm <sup>2</sup><br>2,5 mm <sup>2</sup><br>4,0 mm <sup>2</sup> | Parameterization of the conductor cross-section.  |
| Return via channel     | A<br>B<br>C<br>D<br>E   | RGB(CCT/W), as well as TW illuminants often have common return conductors. This can be taken into account here. |
| Enable measurements    | Yes<br>No   | Enable measurements tab   |
| Enable counters        | Yes<br>No   | Enable counter tab  |

Table 9: Measurements and counters

### 8.2.2.1. Measurements

Note: This tab is only available if parameter "enable measurements" under Measurements and Counters is set to Yes.

Communication objects "Measurement"

|                        | Object enabling   | Cyclical output | Output on change |
|------------------------|---|-----------------|------------------|
| Voltage [power supply] | Off ▼   |                 |                  |
| Power [channel]        | Off ▼   |                 |                  |
| Current [channel]      | Off ▼   |                 |                  |
| Voltage [channel]      | Off ▼   |                 |                  |
| Temperature [device]   | Off ▼   |                 |                  |
| Telegram rate [device] | <input checked="" type="radio"/> No <input type="radio"/> Yes |                 |                  |

Note on data type for voltage measurement:  
 DPT 9.020: Floating point - millivolt  
 DPT 14.027: Floating point - volt

Note on data type for current measurement:  
 DPT 9.021: Floating point - milliampere  
 DPT 14.019: Floating point - ampere

Note on data type for temperature measurement:  
 DPT 9.001: °C  
 DPT 14.068: °C

Figure 28: Measurement

| Parameter        | Selection   | Description   |
|------------------|---|---|
| Enable objects   | Div.  | Enabling of the communication objects for the various measured variables. Depending on the measured variable, it can be parameterized whether communication object(s) for the sum variable or individual channels/channel groups are Released and/or the desired DPT. |
| Cyclic output    | Off<br>1 min<br>5 min<br>10 min<br>30 min<br>60 min | Restriction: The parameter is only available if <ul style="list-style-type: none"> <li>Object release: Not Off or No</li> </ul> Cyclic sending of the communication objects of the measured variable  |
| Output at change | Off<br>> 5 %<br>> 10 %<br>> 20 %<br>> 50 %          | Restriction: The parameter is only available if <ul style="list-style-type: none"> <li>Object release: Not Off or No</li> </ul> Automatic sending of the measured value CO in case of changes by a certain percentage value.  |

Table 10: Measurement

**8.2.2.2. Meter**

Note: This tab is only available if parameter "Enable meter" under Measurements and meter is set to Yes.

Communication objects "Meter"

Average efficiency power supply  %

|              | Object enabling      | Cyclical output meter |
|--------------|----------------------|-----------------------|
| Energy meter | Total (DPT 13.010) ▼ | Off ▼                 |
| Cost meter   | Total (DPT 13.001) ▼ | Off ▼                 |

Electricity price  ct / kWh

Figure 29: Counter

| Parameter      | Selection  | Description   |
|----------------|--|---|
| Enable objects | Off<br>Sum<br>Per channel<br>Sum + Per channel               | Enabling of the communication objects for the various counters. It can be parameterized whether communication object(s) are released for the totalizing variable or individual channels/channel groups. |
| Cyclic output  | Off<br>On the quarter hour<br>On the hour<br>To the full day | Restriction: The parameter is only available if <ul style="list-style-type: none"> <li>Object release: Not Off</li> </ul> Cyclic sending of the communication objects of the respective counters.       |

Table 11: Counter

### 8.2.3. Alarm objects and protection functions

#### Communication objects

Note: The device provides various 1-bit alarm objects that indicate the activity of the integrated protection circuits for overvoltage or undervoltage (power supply), overtemperature and overcurrent (total and channel-specific).

Enable alarm objects?  No  Yes

#### Enabled

Activate additional device protection?  No  Yes

Activate additional lamp protection?  No  Yes

Activate additional power supply protection?  No  Yes

Figure 30: Alarm objects and protection functions

| Parameter                           | Selection | Description  |
|-------------------------------------|-----------|--|
| Enable                              | Yes<br>No | Release communication objects Alarm: undervoltage, overvoltage, overcurrent, overtemperature   |
| Enable additional device protection | Yes<br>No | Release additional device protection: Provides the option to lower the trigger threshold for the integrated overtemperature shutdown.  |
| Enable lamp protection              | Yes<br>No | Release illuminant protection: Provides the possibility to alarm overload scenarios at the illuminant (communication objects) by parameterization of continuous power and inputs for overload capability and to switch off if desired          |
| Enable power supply protection      | Yes<br>No | Release power supply protection: Provides the possibility to alarm overload scenarios at the LED power supply (communication objects) by parameterization of continuous power and inputs for overload capability and to switch off if desired. |

Table 12: Alarm objects and protection functions

### 8.2.3.1. Additional device protection

#### Additional device protection

Note: The device offers hardware protection functions. These are relevant for certification and cannot be deactivated.

To take special environmental conditions into account, trigger thresholds can be adjusted here so that the device switches off at an earlier point.

#### Overtemperature shutdown

The integrated protection circuit provides for a shutdown at 120°C. With the following parameter, this threshold can be lowered if necessary. The corresponding alarm communication object is then also triggered at this threshold.

Overtemperature shutdown at  °C

Figure 31: Additional device protection

| Parameter                   | Selection   | Description  |
|-----------------------------|-------------|--|
| Overtemperature shutdown at | 60 – 120 °C | Defining the threshold above the overtemperature shutdown is triggered |

Table 12: Additional device protection

### 8.2.3.2. Illuminant protection

#### Lamp protection

Note: As some LED strips may not be operated with maximum total current, alarm and protection functions can be parameterised here.

Note: If an overload capability > 0% and a maximum overload duration of 0 s is parameterised, the LED can be permanently overloaded. Alternatively, please parameterise the maximum duration.

**i** As the power is measured in the device, it is mandatory to enter the information on the cable in the "Measurements and meters" menu in order to be able to correctly calculate the power at the lamp.

|                 | Continuous power | Overload capacity | Maximum overload duration |
|-----------------|------------------|-------------------|---------------------------|
| Channel RGB CCT | 100 W            | 20 %              | 20 s                      |

Activate protection shutdown

When exceeding the maximum power or the I<sup>2</sup>t value

Figure 32: Illuminant protection

| Parameter                  | Selection   | Description   |
|----------------------------|---|---|
| Continuous power           | 1 – 480 W   | Parameterization of the continuous power of the illuminants of the channel / channel group in watts.  |
| Overload capacity          | 0 – 100 %   | Parameterization of the overload capacity of the illuminant of the channel / channel group in percent.<br><br>Recommendation: 20%   |
| Maximum duration overload  | 0 – 36000 s   | Parameterization of how long the overload parameterized under "Overload capacity" may be present. If 0 is parameterized here, the illuminant may be permanently overloaded.<br><br>Recommendation: 20 s   |
| Enable protective shutdown | Off<br><br>When the continuous power is exceeded<br><br>When exceeding the I <sup>2</sup> t value<br><br>When the maximum power is exceeded<br><br>When exceeding the maximum power or the I <sup>2</sup> t value | Definition of whether lamp overload should lead to shutdown.<br>Options:<br><br>Shutdown at:<br>- Exceeding of the parameterized continuous load<br>- Exceeding of the parameterized maximum load<br>- Exceeding the I <sup>2</sup> t threshold defined by overload capacity and duration (see chapter Illuminant protection)<br>Recommendation: When exceeding the maximum power or the I <sup>2</sup> t value |

Table 13: Illuminant protection

### 8.2.3.3. Power supply protection

#### Power supply protection

Note: In addition, the device can also protect the upstream LED power supply.

Note: If an overload capability > 0% and a maximum overload duration of 0 s is parameterised, the LED power supply can be permanently overloaded. Alternatively, please parameterise the maximum duration.

|              | Continuous power | Overload capacity | Maximum overload duration |
|--------------|------------------|-------------------|---------------------------|
| Power supply | 100 W            | 20 %              | 60 s                      |

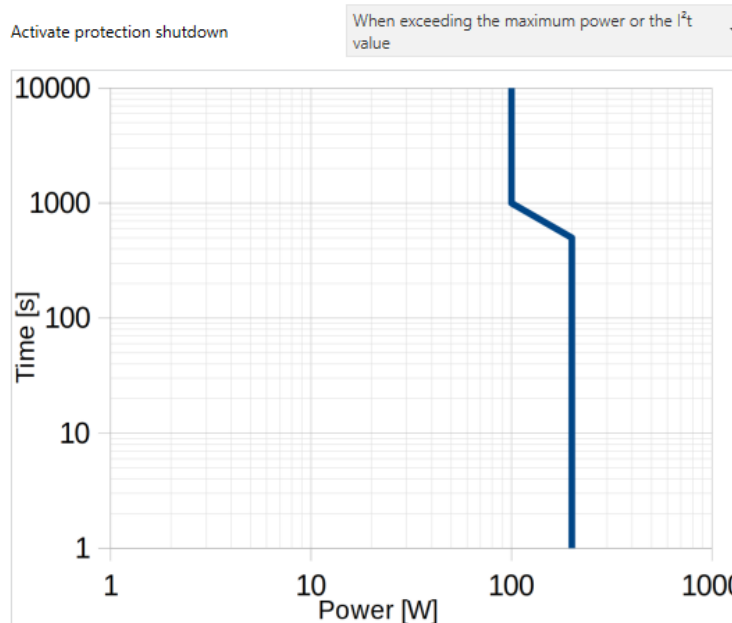

Figure 33: Parameter Netzteilsschutz

| Parameter                  | Selection   | Description   |
|----------------------------|---|---|
| Continuous power           | 1 – 1000 W  | Parameterization of the continuous power of the channel / channel group in watts.   |
| Overload capacity          | 0 – 100 %   | Parameterization of the overload capacity of the channel / channel group in percent.<br>Recommendation: 20%   |
| Maximum duration overload  | 0 – 36000 s   | Parameterization of how long the overload parameterized under "Overload capacity" may be present. If 0 is parameterized here, the power supply may be permanently overloaded.<br>Recommendation: 60 s   |
| Enable protective shutdown | Off<br>When the continuous power is exceeded<br>When exceeding the I <sup>2</sup> t value<br>When the maximum power is exceeded<br>When exceeding the maximum power or the I <sup>2</sup> t value | Definition of whether power supply overload should lead to shutdown.<br>Options: Shutdown at: <ul style="list-style-type: none"> <li>Exceeding of the parameterized continuous load</li> <li>Exceeding of the parameterized maximum load</li> <li>Exceeding of the I<sup>2</sup>t threshold defined by overload capacity and duration (see chapter Power supply protection)</li> </ul> Recommendation: When exceeding the maximum power or the I <sup>2</sup> t value |

Table 14: Parameter Netzteilsschutz



## 8.2.4. Channel configuration

### 8.2.4.1. Single channel

Note: This channel is only available if an "Operating mode" is selected under General that contains at least one individual channel and this is selected under "Use" (see General).

Note: The parameters that are parameterized as "Each channel individual" under General / Configuration also appear in this case here in the channel in the corresponding tabs. Selection and description are analogous to "All channels identical"

Channel A - configuration

Channel designation

**i** The following parameters contain channel-specific dimming settings. Cross-channel dimming settings can be found under "General".

Switch-on behaviour

Switch-on brightness day  %

Switch-on brightness night  %

---

Limit dimming range

Note: You can choose between minimum / maximum brightness and scaled minimum / maximum brightness (this scales the limited brightness range to 0 - 100%).

Figure 34: Single Channel

| Parameter                  | Selection   | Description   |
|----------------------------|---|---|
| Name                       | Text  | Free definition of a channel name. This is used for the parameter tabs and for the names of the communication objects for an optimum overview   |
| Switch on behavior         | Fixed value<br>Fixed value [day / night distinction]<br>Last value<br>Last value [day / night distinction]    | Definition of the switch-on behavior (switching on via switch object):<br><br>Fixed value or Last value (this is saved when switching off). In both cases, it is also possible to specify whether there should be a differentiation between day and night.  |
| Switch-on brightness       | 0 – 100 %   | Restriction: The parameter is only available, if <ul style="list-style-type: none"> <li>Switch on behavior: Fixed value</li> </ul> Definition of the channel brightness for the switch-on process   |
| Switch-on brightness day   | 0 – 100 %   | Restriction: The parameter is only available, if <ul style="list-style-type: none"> <li>Switch on behavior: Fixed value [day / night distinction]</li> </ul> Definition of the channel brightness for the switch-on process   |
| Switch-on brightness night | 0 – 100 %   | Restriction: The parameter is only available, if <ul style="list-style-type: none"> <li>Switch on behavior: Fixed value [day / night distinction]</li> </ul> Definition of the channel brightness for the switch-on process   |
| Limit dimming range        | Off<br>Limit<br>Limit [day / night distinction]<br>Scalable limit<br>Scalable limit [day / night distinction] | Definition of whether the dimming range for the channel is to be limited.<br>Two alternatives are available for this:<br>Scalable limit: The range between parameterized minimum and maximum brightness is scaled to 0 to 100 %.<br>Limit: The range between the parameterized minimum and maximum brightness is not scaled to 0 to 100 %. If values greater than the maximum value or less than the minimum value are dimmed, the maximum value or minimum value is dimmed.<br>Absolute dimming 0% always switches off. In both cases, it is also possible to specify whether there should be a distinction between day and night. |

|                          |           |  |
|--------------------------|-----------|--|
| Minimum brightness       | 0 – 100 % | <p>Restriction: The parameter is only available if</p> <ul style="list-style-type: none"> <li>Limit dimming range: Not "Off</li> </ul> <p>Defining the brightness for the channel.</p>   |
| Maximum brightness       | 0 – 100 % |  |
| Maximum brightness day   | 0 – 100 % | <p>Restriction: The parameter is only available, If</p> <ul style="list-style-type: none"> <li>Limit dimming range: Limit [day / night distinction] oder Scalable limit [day / night distinction]</li> </ul> <p>Defining the brightness for the channel.</p> |
| Maximum brightness night | 0 – 100 % | <p>Restriction: The parameter is only available, If</p> <ul style="list-style-type: none"> <li>Limit dimming range: Limit [day / night distinction] oder Scalable limit [day / night distinction]</li> </ul> <p>Defining the brightness for the channel.</p> |

*Table 15: Single channel*

### 8.2.4.2. RGB - Configuration

Note: The RGB channel group is only available if an "Operating mode" containing the channel group is selected under General and this is selected under "Use" (see General).

Note: The parameters that are parameterized as " Each channel individual " under General / Configuration also appear in this case here in the channel in the corresponding tabs. Selection and description are analogous to " All channels identical ".

**RGB - Konfiguration**

Bezeichnung des Kanals

**i** Unter den nachfolgenden Parametern befinden sich kanalspezifische Dimmeinstellungen. Kanalübergreifende Dimmeinstellungen finden Sie unter "Allgemein"

Einschaltverhalten

Farbwert Einschalten

---

Dimmbereich begrenzen

|                     | R     | G     | B     |
|---------------------|-------|-------|-------|
| Maximale Helligkeit | 100 % | 100 % | 100 % |

Hinweis: Der begrenzte Dimmbereich wird später zur Laufzeit skaliert auf 0 bis 100 %.

Figure 35: RGB - Configuration

| Parameter             | Selection  | Description  |
|-----------------------|--|--|
| Name                  | Text   | Free definition of a channel name. This is used for the parameter tabs and for the names of the communication objects for an optimum overview  |
| Switch on behavior    | Fixed value<br>Fixed value [day / night distinction]<br>Last value<br>Last value [day / night distinction] | Definition of the switch-on behavior (switching on via switch object):<br>Fixed value or Last value (this is saved when switching off). In both cases, it is also possible to specify whether there should be a differentiation between day and night.   |
| Switch on value       | RGB-value  | Restriction: The parameter is only available, if <ul style="list-style-type: none"> <li>Switch on behavior: Fixed value</li> </ul> Definition of the RGB color value for the switch-on process   |
| Switch on value day   | RGB- value   | Restriction: The parameter is only available, if <ul style="list-style-type: none"> <li>Switch on behavior: Fixed value [day / night distinction]</li> </ul> Definition of the RGB color value for the switch-on process   |
| Switch on value night | RGB-Wert   |  |
| Limit dimming range   | Off<br>CO<br>Parameter   | Definition of the maximum brightness of individual channels to be limited.<br><br>The limited dimming range is later scaled to the values 0 to 100 % at runtime.<br>Options:<br>CO: The limitation is made during operation (see the description of communication object 204 in chapter Communication objects ).<br>Parameter: A parameter for defining the max. brightness is available for each channel of the channel group |
| Maximum brightness    | Red: 0 – 100 %<br>Green: 0 – 100 %<br>Blue: 0 – 100 %  | Restriction: The parameter is only available if <ul style="list-style-type: none"> <li>Limit dimming range: Parameter</li> </ul> Definition of the max. brightnesses for the individual channels of the channel group.   |

Table 16: RGB - Configuration

**8.2.4.3. RGBW – White channel**

Note: The RGBW channel group is only available if the corresponding operating mode is selected under General and this is selected under "Use" (see General).

Note: The parameters that are parameterized as " Each channel individual " under General / Configuration also appear in this case here in the channel in the corresponding tabs. Selection and description are analogous to " All channels identical ".

Note: The settings of the RGBW application essentially correspond to those of RGB - Configuration supplemented by settings for the white channel. Only these are shown here.

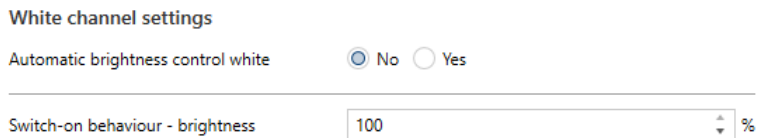

Figure 36: White Channel

| Parameter                          | Selection | Description   |
|------------------------------------|-----------|---|
| Automatic brightness control White | Yes<br>No | Specifies whether the white channel should be automatically mixed depending on the current saturation value (see RGBW)  |
| Switch-on behavior - brightness    | 0 – 100 % | Restriction: The parameter is only available, if <ul style="list-style-type: none"> <li>Automatic brightness control White - No</li> </ul> Defines the switch-on brightness for the white channel |

Table 17: White Channel

### 8.2.4.4. RGBCCT (as RGB-Extended) – White channel

Note: The RGBCCT channel group is only available if the corresponding operating mode is selected under General in conjunction with the RGB-Extended extension and the channel group is selected under "Use" (see General).

Note: The parameters that are parameterized as " Each channel individual" under General / Configuration also appear here in the channel in the corresponding tabs in this case. Selection and description are analogous to " All channels identical".

**White channel settings**

Automatic brightness control white  No  Yes

Behaviour maximum brightness  Total brightness 100%  
 Brightness 100% per channel

Note: The "Brightness 100% per channel" setting can lead to overloading of the lamps, as they are often designed for the total power of 100%.

Indication of the mixing ratio between cold and warm white  Cold white proportion in %  
 Colour temperature in Kelvin

**i** Please state the colour temperatures of the warm white or cold white lamp.

**i** If a value is not within the colour temperature range, the warm white value is used if the value falls below the range, and the cold white value is used if the value exceeds the range.

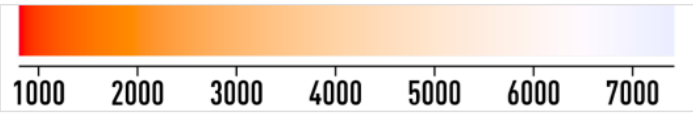

Colour temperature warm white  K

Colour temperature cold white  K

---

Mixing ratio of white channels  Fixed value  Configurable

Colour temperature  K

---

Switch-on behaviour - brightness  %

Figure 37: Parameter RGBCCT (as RGB-Extended) – White channel

| Parameter   | Selection  | Description  |
|---|--|--|
| Automatic brightness control White                            | Yes<br>No  | Specifies whether the white channels should be automatically mixed depending on the current saturation value (see RGCCT: Extended-RGB).  |
| Behavior Maximum brightness                                   | Total brightness 100 %<br>brightness 100 % per channel | Defines if the Tunable-White brightness refers to the sum brightness of cool and warm white or if 100 % per channel should be controlled.<br>Note: The setting "100 % per channel" can lead to an overload of the illuminants, as they are often only designed for a sum power of 100 %  |
| Specification of the mixing ratio between cold and warm white | Cold white in %<br>Temperature in K                    | Definition whether all parameters and CO concerning the TW mixing ratio are to be released as "Cold white ratio in %" or as "Light temperature in Kelvin". In the latter case, specifications must be made for the color temperatures of both channels CW and WW   |
| Color temperature warm white                                  | 1800 – 3300 Kelvin                                     | Restriction: The parameter is only available, If <ul style="list-style-type: none"> <li>• Specification of the mixing ratio between cold and warm white: Light temperature in Kelvin</li> </ul> Definition of the color temperature of the used illuminant.  |
| Color temperature cold white                                  | 4700 – 7000 Kelvin                                     |  |
| Mixing ratio  | Fixed<br>Parameterizable                               | Specifies whether the mixing ratio of the white channels is to be defined as fixed here or whether it is to be flexibly parameterizable for the individual operating modes   |
| Proportion cold white   | 0 – 100 %  | Restriction: The parameter is only available if <ul style="list-style-type: none"> <li>• Specification of the mixing ratio between cold and warm white:</li> <li>• Mixing ratio of white channels: Fixed</li> </ul> Definition of the fixed color temperature for the TW channel group   |
| Farbtemperatur  | 600 – 11000 Kelvin                                     |  |
| CO Release mixing ratio                                       | Yes<br>No  | Restriction: The parameter is only available if <ul style="list-style-type: none"> <li>• Mixing ratio of the white channels: Parameterizable</li> </ul> Release communication object for absolute or relative dimming of TW color temperature.   |
| Switch-on behavior - Brightness                               | 0 – 100 %  | Restriction: The parameter is only available, If <ul style="list-style-type: none"> <li>• Automatic brightness control White: No</li> </ul> Definition of switch-on brightness for the TW channel group.   |
| Switch-on behavior - CW ratio                                 | 0 – 100 %  | Restriction: The parameter is only available, If <ul style="list-style-type: none"> <li>• Automatic brightness control white: No</li> <li>• Specification of mixing ratio between cold and warm white: Proportion of cold white in %.</li> <li>• Mixing ratio of white channels: Parameterizable</li> </ul> Specification of the color temperature for the TW channel group..        |
| Switch-on behavior - color temperature                        | 600 – 11000 Kelvin                                     | Restriction: The parameter is only available, If <ul style="list-style-type: none"> <li>• Automatic brightness control white: No</li> <li>• Specification of mixing ratio between cold and warm white:</li> <li>• Light temperature in Kelvin</li> <li>• Mixing ratio of white channels: Parameterizable</li> </ul> Specification of the color temperature for the TW channel group. |

Table 18: Parameter RGCCT (as RGB-Extended) – White channel

### 8.2.4.5. Tunable White - Configuration

Note: The TW channel group is only available if an "Operating mode" is selected under General that contains the channel group and is selected under "Use" (see General).

Note: The parameters that are configured as " Each channel individual " under General / Configuration also appear here in the corresponding tabs in the channel. The selection and description are analogous to " All channels identical".

Note: The parameters shown here for Tunable White channel 1 (TW 1) apply analogously to TW 2.

**Tunable White 1 - configuration**

Brightness all channels TW 1:

**i** The following parameters contain channel-specific dimming settings. Cross-channel dimming settings can be found under "General".

Behaviour maximum brightness  Total brightness 100%  
 Brightness 100% per channel

Indication of the mixing ratio between cold and warm white  Cold white proportion in %  
 Colour temperature in Kelvin

**i** Please state the colour temperatures of the warm white or cold white lamp.

**i** If a value is not within the colour temperature range, the warm white value is used if the value falls below the range, and the cold white value is used if the value exceeds the range.

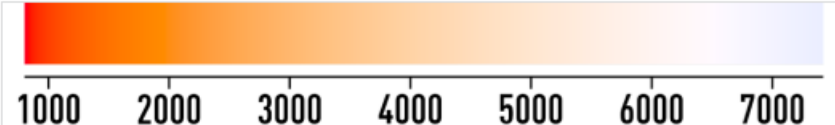

Colour temperature warm white 2000  K

Colour temperature cold white 6500  K

Switch-on behaviour Memory value [value before last switch-off] ▼

---

Limit dimming range Off ▼

Note: You can choose between minimum / maximum brightness and scaled minimum / maximum brightness (this scales the limited brightness range to 0 - 100%).

Note: For Tunable White channel groups, the maximum value refers to the value configured under the "Maximum brightness behaviour" parameter.

Figure 38: Parameter TW – Configuration

| Parameter                             | Selection  | Description   |
|---------------------------------------|--|---|
| Name                                  | Text   | Free definition of a channel group name. This is adopted for the parameter tabs as well as for the names of the communication objects for an optimal overview.  |
| Behavior maximum brightness           | Total brightness 100 %<br>Brightness 100 % per Channel   | Determination of whether the tunable white brightness relates to the total brightness of cold and warm white, or 100% per channel should be controlled.<br>Note: The setting "100% per channel" can lead to overloading of the lamps, as these are often only designed for a total output of 100%.  |
| Mixing ratio                          | Cold White %<br>Kelvin   | Determination of whether all parameters and CO relating to the TW mixing ratio should be released as "cold white%" or as "light temperature in Kelvin". In the latter case, information about the color temperatures of the two channels CW and WW must be made.  |
| Color Temperatur Warm white           | 1800 – 3300 Kelvin   | Restriction: The parameter is only available, if <ul style="list-style-type: none"> <li>• Specification of the mixing ratio between cold and warm white: Light temperature in Kelvin.</li> </ul>  |
| Color Temperatur Cold white           | 4700 – 7000 Kelvin   | Specifies the color temperature of the illuminant used  |
| Switch-on behavior                    | Fixed value<br>Fixed value [day / night distinction]<br>Last value<br>Last value [day / night distinction] | Definition of the switch-on behavior (switching on via switch object): <ul style="list-style-type: none"> <li>• Fixed value or Last value (this is saved when switching off).</li> </ul> In both cases, it is also possible to specify whether there should be a distinction between day and night.   |
| Switch on behavior - brightness       | 0 – 100 %  | Restriction: The parameter is only available, if <ul style="list-style-type: none"> <li>• Switch on behavior: Fixed value</li> </ul> Definition of the TW brightness for the switch-on process  |
| Switch on behavior – brightness day   | 0 – 100 %  | Restriction: The parameter is only available, if <ul style="list-style-type: none"> <li>• Switch on behavior: Fixed value [day / night distinction]</li> </ul> Definition of the TW brightness for the switch-on process  |
| Switch on behavior – brightness night | 0 – 100 %  | Restriction: The parameter is only available, if <ul style="list-style-type: none"> <li>• Switch on behavior: Fixed value [day / night distinction]</li> </ul> Definition of the TW brightness for the switch-on process  |
| Switch on behavior – % Cold white     | 0 – 100 %  | Restriction: The parameter is only available, if <ul style="list-style-type: none"> <li>• Switch on behavior: Fixed value</li> <li>• Specification of mixing ratio between cold and warm white: Proportion of cold white in %.</li> <li>• TW 1 / Dimming settings / Activate Dim-2-Warm: No</li> </ul> Specification of the CW proportion for the switch-on process                           |
| Switch on behavior – % Cold white day | 0 – 100 %  | Restriction: The parameter is only available, if <ul style="list-style-type: none"> <li>• Switch on behavior: Fixed value [day / night distinction]</li> <li>• Specification of mixing ratio between cold and warm white: Proportion of cold white in %.</li> <li>• TW 1 / Dimming settings / Activate Dim-2-Warm: No</li> </ul> Specification of the CW proportion for the switch-on process |



|  |  |  |
|--|--|--|
| Switch on behavior – % Cold white night    | 0 – 100 %  | <p>Restriction: The parameter is only available, if</p> <ul style="list-style-type: none"> <li>• Switch on behavior: Fixed value [day / night distinction]</li> <li>• Specification of mixing ratio between cold and warm white: Proportion of cold white in % <ul style="list-style-type: none"> <li>• TW 1 / Dimming settings / Activate Dim-2-Warm: No</li> </ul> </li> </ul> <p>Specification of the CW proportion for the switch-on process</p>   |
| Switch on behavior – Color temperature     | 600 – 11000 Kelvin   | <p>Restriction: The parameter is only available, if</p> <ul style="list-style-type: none"> <li>• Switch on behavior: Fixed value</li> <li>• Specification of mixing ratio between cold and warm white: Light temperature in Kelvin</li> <li>• TW 1 / Dimming settings / Activate Dim-2-Warm: No</li> </ul> <p>Specification of the color temperature for the switch-on process.</p>  |
| Switch on behavior Color temperature day   | 600 – 11000 Kelvin   | <p>Restriction: The parameter is only available, if</p> <ul style="list-style-type: none"> <li>• Switch on behavior: Fixed value [day / night distinction]</li> <li>• Specification of mixing ratio between cold and warm white: Light temperature in Kelvin <ul style="list-style-type: none"> <li>• TW 1 / Dimming settings / Activate Dim-2-Warm: No</li> </ul> </li> </ul> <p>Specification of the color temperature for the switch-on process.</p>  |
| Switch on behavior Color temperature night | 600 – 11000 Kelvin   |  |
| Limit dimm range                           | <p>Off</p> <p>Limit</p> <p>Limit [day / night distinction]</p> <p>Scalable limit</p> <p>Scalable limit [day / night distinction]</p> | <p>Definition of whether the dimming range for the channel group is to be limited. Two alternatives are available for this:</p> <p>Scalable limit: The range between parameterized minimum and maximum brightness is scaled to 0 to 100 %.</p> <p>Limit: The range between the parameterized minimum and maximum brightness is not scaled to 0 to 100 %. If values greater than the maximum value or less than the minimum value are dimmed, the maximum value or minimum value is dimmed. Absolute dimming 0% always switches off.</p> <p>In both cases, it is also possible to specify whether there should be a distinction between day and night</p> |
| Minimum brightness                         | 0 – 100 %  | <p>Restriction: The parameter is only available if</p> <ul style="list-style-type: none"> <li>• Limit dimming range: Not "Off"</li> </ul> <p>Defines the minimum brightness for the channel group</p>  |
| Maximum brightness                         | 0 – 100 %  | <p>Restriction: The parameter is only available if</p> <p>Limit dimming range: Limit or Scalable limit [Day / night]</p> <p>Defines the maximum brightness for the channel group</p>   |
| Maximum brightness day                     | 0 – 100 %  |  |
| Maximum brightness night                   | 0 – 100 %  |  |

Table 19: TW - Configuration

**Tunable White – Dimming settings**

Note: The TW channel group is only available if an "Operating mode" containing the channel group is selected under General and this is selected under "Use" (see General).

Note: The parameters that are parameterized as " Each channel individual " under General / Configuration also appear in this case here in the channel in the corresponding tabs. Selection and description are analogous to " All channels identical ".

Note: The parameters shown here for Tunable White channel 1 (TW 1) apply analogously to TW 2.

**TW 1 - dimming settings**

The following parameters contain channel-specific dimming settings. Cross-channel dimming settings can be found under "General".

Activate Dim-2-Warm?  No  Yes

**i** If Dim-2-Warm is activated, the behaviour of the lamp is fixed and the colour temperature cannot be changed further.

|                               | Brightness threshold value | Colour temperature          |
|-------------------------------|----------------------------|-----------------------------|
| <b>Brightness threshold 1</b> | 20 <input type="text"/> %  | 2700 <input type="text"/> K |
| <b>Brightness threshold 2</b> | 60 <input type="text"/> %  | 6500 <input type="text"/> K |

Note:  
 -> Colour temperature 1 for brightness values < Threshold value 1  
 -> Colour temperature 2 for brightness values > Threshold value 2  
 -> Interpolation of the colour temperature between the two threshold values

Figure 39: Dimming settings

| Parameter                   | Selection          | Description   |
|-----------------------------|--------------------|---|
| Dim-2-Warm                  | Yes<br>No          | Activate Dim-2-Warm<br>Note: If active, all parameters and communication objects concerning the mixing ratio are not released for the entire channel group  |
| Threshold values brightness | 0 – 100 %          | Restriction: The parameter is only available if <ul style="list-style-type: none"> <li>• Activate Dim-2-Warm: Yes</li> </ul> Definition of the two interpolation points.  |
| Color temperature           | 0 – 100 %          | Restriction: The parameter is only available if <ul style="list-style-type: none"> <li>• Release Dim-2-Warm: Yes</li> <li>• Specification of mixing ratio between cold and warm white: Proportion of cold white in %.</li> </ul> Definition of the color temperature in cold white % for the two supporting points. |
| Farbtemperatur              | 600 – 11000 Kelvin | Restriction: The parameter is only available if <ul style="list-style-type: none"> <li>• Release Dim-2-Warm: Yes</li> <li>• Definition of mixing ratio between cold and warm white: Light temperature in Kelvin</li> </ul> Definition of the color temperature in Kelvin for the two supporting points              |

Table 20: Dimming settings

### 8.2.4.6. RGBCCT (as TW-Extended) - Configuration

Note: The RGBCCT channel group is only available if the corresponding operating mode in connection with the extension TW-Extended is selected under General and the channel group underneath is selected under "Use" (see General).

Note: The parameters that are configured as " Each channel individual " under General / Configuration also appear here in the corresponding tabs in the channel. The selection and description are analogous to " All channels identical".

Note: The settings of the RGBCCT application (as TW-Extended) essentially correspond to those of Tunable White – Dimming settings, supplemented by settings for adding the color channels. Only these are shown here.

Tunable White 1 - configuration

Brightness all channels TW 1:

**Please state the colour temperatures of the warm white or cold white lamp.**

If a value is not within the colour temperature range, the warm white value is used if the value falls below the range, and the cold white value is used if the value exceeds the range.

Colour temperature warm white  K

Colour temperature cold white  K

Minimum value  K

Maximum value  K

**The following parameters contain channel-specific dimming settings. Cross-channel dimming settings can be found under "General".**

Behaviour maximum brightness  Total brightness 100%  Brightness 100% per channel

Indication of the mixing ratio between cold and warm white  Cold white proportion in %  Colour temperature in Kelvin

Switch-on behaviour

Limit dimming range

Note: You can choose between minimum / maximum brightness and scaled minimum / maximum brightness (this scales the limited brightness range to 0 - 100%).

Note: For Tunable White channel groups, the maximum value refers to the value configured under the "Maximum brightness behaviour" parameter.

Figure 40: RGBCCT (as TW-Extended) – Configuration

| Parameter                    | Selection           | Description   |
|------------------------------|---------------------|---|
| Color temperature warm white | 1800 – 3300 Kelvin  | Definition of the color temperature of the warm white illuminant used         |
| Color temperature cold white | 4700 – 7000 Kelvin  | Definition of the color temperature of the cool white light source used.      |
| Minimum color temperature    | 600 – 1800 Kelvin   | Extension of the color temperature range down to the value configured here    |
| Maximum color temperature    | 7000 – 11000 Kelvin | Extension of the color temperature range upwards to the value configured here |

Table 21: RGBCCT (as TW-Extended) – Configuration

### 8.2.4.7. RGBW (as Virtualized TW) - Configuration

Note: The TW channel group is only available if the RGBW operating mode in connection with the parameter "Activate virtualized tunable white" is selected under General and the channel group is selected under "Use" (see General).

Note: The parameters that are configured as "Each channel individual" under General / Configuration also appear here in the corresponding tabs in the channel. The selection and description are analogous to "All channels identical".

Note: The settings of the RGBW application (with sim. TW) essentially correspond to those of Tunable White – Dimming settings, supplemented by settings for adding the color channels. Only these are shown here.

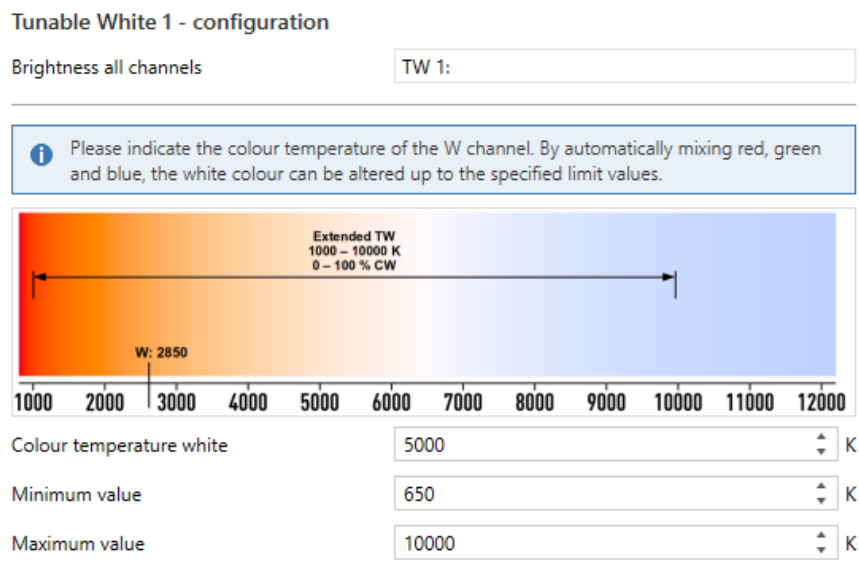

Figure 41: RGBW (as virt. TW) – Configuration

| Parameter               | Selection           | Description   |
|-------------------------|---------------------|---|
| Color temperature white | 600 – 11000 Kelvin  | Definition of the color temperature of the used white illuminant.             |
| Minimum value           | 600 – 4500 Kelvin   | Extension of the color temperature range down to the here parameterized value |
| Maximum value           | 4500 – 11000 Kelvin | Extension of the color temperature range up to the here parameterized value   |

Table 22: RGBW (as virt. TW) – Configuration

### 8.2.5. Enabled functions

Note: This tab is available for every channel / every channel group

Tunable White 1 - enabled

Enable stairwell function?  No  Yes

Enable scenes?  No  Yes

Enable bit scenes?  No  Yes

Enable disabling functions?  No  Yes

Enable sequences?  No  Yes

Number of sequences

Enable time-controlled dimming (HCL)?  No  Yes

Figure 42: Enabled functions

| Parameter               | Selection | Description   |
|-------------------------|-----------|---|
| Stairway                | Yes<br>No | Enable stairway lighting function   |
| Scenes                  | Yes<br>No | Enable scenes   |
| Bitscenes               | Yes<br>No | Enable bitscenes  |
| Disabling function      | Yes<br>No | Enable disabling functions  |
| Sequences               | Yes<br>No | Restriction: The parameter is only available for RGB (CCT / W) and TW channel groups.<br>Release Sequences                      |
| Number of sequences     | 1 - 5     | Restriction: The parameter is only available for RGB (CCT / W) and TW channel groups.<br>Set number of sequences                |
| Time-controlled dimming | Yes<br>No | Time-controlled dimming or HCL<br>Note: HCL (=Human Centric Lighting = time-controlled dimming in operating mode Tunable White) |

Table 23: Enabled functions

### 8.2.5.1. Stairway function

The stairway lighting function releases a luminaire triggered by a motion detector, for example, to be switched off again automatically after a parameterized activation time. If a new trigger occurs during the activation time, this can either be ignored, the time restarted or added up.

Furthermore, if desired, a dimming time and brightness can be parameterized. As a warning for the user that the lighting is about to go out, this brightness is controlled for the duration of the dimming time after the activation time has elapsed.

When the stairway lighting function is activated, the switch-on brightness and switch-on speed result from the settings made under Configuration or Dimming settings.

Of course, the so-called "stairway lighting function" can not only be used for stairway lighting but is generally suitable for all areas of application in which the lighting is to go out again automatically after a defined time.

Note: The function is shown here for the operating mode RGBCCT (as RGB Extended) with deactivated automatic white admixture, as this offers the maximum number of parameters. The parameters Color Temperature White are also shown here in Cold White %. The parameters can also be set in Kelvin if the parameter "Specification of mixing ratio between warm and cool white" is changed accordingly (RGBCCT (as RGB-Extended) – White channels).

For other operation modes the parameters for brightness, color selection, CW ratio are reduced accordingly.

Note: This tab is only available if parameter "Release stairway lighting function" under Channel group / Release is set to Yes.

**TW 1 - stairwell function**

Stairwell time  s

**i** The switch-on behaviour (speed and brightness) results from the corresponding general and channel-specific parameters.

Retrigger stairwell

Switch-off advance warning  No  Yes

Reaction to Off telegram  No  Yes

Time factor specification via bus  No  Yes

Figure 43: Stairway function

| Parameter  | Selection                                      | Description  |
|--|--|--|
| Stairwell time   | 0 – 3600 s                                     | Definition of the activation duration of the stairway lighting.  |
| Retrigger  | No Reaction<br>Start time again<br>Add-up time | Definition of the behavior if a new trigger occurs during the activation time. <ul style="list-style-type: none"> <li>• No reaction: The current process continues unaffected.</li> <li>• Restart time: The running process continues with the new remaining time = activation time stairway lighting.</li> <li>• Add time: The current process continues with the new remaining time = Old remaining time + Activation time stairway lighting.</li> </ul> |
| Switch off warning                                       | Yes<br>No                                      | Definition of whether a temporary, dimmed value is to be approached after the activation time has elapsed. If no is parameterized here, it is switched off.  |
| Time   | 0 – 3600 s                                     | Restriction: The parameter is only available if <ul style="list-style-type: none"> <li>• Switch off warning: Yes</li> </ul> Definition of the time for which the dimmed brightness is to be maintained   |
| Value  | 0 – 100 %                                      | Restriction: The parameter is only available if <ul style="list-style-type: none"> <li>• Switch off warning: Yes</li> </ul> Definition of the dimmed brightness. In single channel mode the value corresponds to the new channel brightness, in TW to the TW brightness and in RGB channel groups the individual colors are scaled starting from the switch-on brightness  |
| Off telegram   | Yes<br>No                                      | Definition of whether the stairway lighting can be switched off during the activation time by means of the CO "Switch stairway lighting" OFF.  |
| Timer factor   | Yes<br>No                                      | Release the "Stairway lighting time factor" communication object, which can be used to assign an integer factor to the parameterized activation time.  |
| Activate staircase function via "Staircase timer" object | Yes No   | Defines whether sending a factor to CO "Stairway timer factor" also starts the stairway lighting function immediately or not.  |

Table 24: Stairwell function

### 8.2.5.2. Scenes

The device has a scene function. Using the 8-bit scene address, up to eight different scenes can be stored per channel or channel group (e.g. RGB). Each scene can be assigned a scene number (1 ... 64). The scene is to be understood as a specific lighting setting. When controlling the scenes, the brightness value is changed with the speed of the absolute dimming.

Note: The function is shown here for the operating mode RGBCCT (as RGB Extended) with deactivated automatic white admixture, as this offers the maximum number of parameters. The parameters Color Temperature White are also shown here in Cold White %. The parameters can also be set in Kelvin if the parameter "Specification of mixing ratio between warm and cool white" is changed accordingly (see RGBCCT (as RGB-Extended) – White channels). For other operation modes the parameters for brightness, color selection, CW proportion are reduced accordingly.

Note: This tab is only available if parameter "Release scenes" under Channel group / Releases is set to Yes.

RGB - scenes

Enable saving?  No  Yes

---

Enable scene A  No  Yes

Enable scene B  No  Yes

Enable scene C  No  Yes

Enable scene D  No  Yes

Enable scene E  No  Yes

Enable scene F  No  Yes

Enable scene G  No  Yes

Enable scene H  No  Yes

---

|         | Number | Action      | RGB     | Brightness white | Colour temp. White |
|---------|--------|-------------|---------|------------------|--------------------|
| Scene A | 1      | Fixed value | #2A96BD | 0                | 4000 K             |

Figure 44: Scenes



| Parameter   | Selection                                  | Description   |
|---|--|---|
| Saving  | Yes<br>No                                  | Defines whether the parameterized brightnesses for a scene can also be overwritten (saved) during operation.  |
| Overwrite saved brightness when reprogramming the application program | Yes<br>No                                  | Restriction: The parameter is only available, If <ul style="list-style-type: none"> <li>• Enable saving: Yes</li> </ul> Defines whether the brightness saved during operation is to be overwritten with a reprogramming of the application via ETS.   |
| Scene [A-H]   | Yes<br>No                                  | Release parameters of the selected scene and communication object.  |
| Scene number  | 1 – 64                                     | Determination of the scene number. This number can be called up or saved (overwritten) during operation via the scene object.   |
| Scene action  | Brightness<br>Switch on value<br>No change | Defines what happens when a scene is called up:<br>Brightness value: A parameterized brightness is approached.<br>Switch-on value or switch-on value day / night: The switch-on brightness is approached. If a day / night distinction is parameterized for the switchon behavior, the corresponding value is approached.<br>No change: The current brightness value remains unchanged. |
| RGB   | RGB-value                                  | Restriction: The parameter is only available, If <ul style="list-style-type: none"> <li>• Scene Action: Brightness value</li> </ul> Defines the RGB color value for the scene   |
| Brightness white  | 0 – 100 %                                  | Restriction: The parameter is only available, If <ul style="list-style-type: none"> <li>• Szene Aktion: Helligkeitswert</li> <li>• Weißkanäle / Automatische Helligkeitssteuerung Weiß: No</li> </ul> Defines the TW brightness for the scene   |
| Color temperature white   | 0 – 100 %                                  | Restriction: The parameter is only available, If <ul style="list-style-type: none"> <li>• Scene Action: Brightness value</li> <li>• White channels / Automatic brightness control White: No</li> </ul> Defines the TW Color temperature for the scene   |

Table 25: Scenes

### 8.2.5.3. Bit scenes

For each channel or channel group (e.g. RGB), the device 5x has five bit scene objects. This allows, for example, a specific lighting setting to be specified directly with any single pushbutton. Two bit scenes can be loaded with each of these objects (one parameterization each for 0 and 1). When the bit scenes are activated, the brightness value is changed at the speed of the absolute dimming.

Note: The function is shown here for the operating mode RGBCCT (as RGB Extended) with deactivated automatic white admixture, as this offers the maximum number of parameters. The parameters Color Temperature White are also shown here in Cold White %. The parameters can also be set in Kelvin if the parameter "Specification of mixing ratio between warm and cool white" is changed accordingly (see RGBCCT (as RGB-Extended) – White channels). For other operation modes the parameters for brightness, color selection, CW proportion are reduced accordingly.

Note: This tab is only available if parameter "Release bit scenes" under Channel group / Releases is set to Yes.

RGB - bit scenes

Enable bit scene 1  No  Yes

Enable bit scene 2  No  Yes

Enable bit scene 3  No  Yes

Enable bit scene 4  No  Yes

Enable bit scene 5  No  Yes

|                           | Action      | RGB     | Brightness white | Colour temp. White |
|---------------------------|-------------|---------|------------------|--------------------|
| Bit scene 1 for value "1" | Fixed value | #F0C610 | 0 %              | 4000 K             |
| Bit scene 1 for value "0" | Fixed value | #000000 | 0 %              | 4000 K             |

Figure 45: Bit scenes

| Parameter               | Selection   | Description   |
|-------------------------|---|---|
| Enable bit scene        | Yes<br>No   | Release the parameters and communication objects of the selected Bit scenes   |
| Aktion                  | Brightness value<br>Switch on value<br>switch-on value day / night<br>No change | Defines what happens when the bitscene is called up for the value 1 or 0: <ul style="list-style-type: none"> <li>Brightness value: A parameterized brightness is approached.</li> <li>Switch-on value or Switch-on value day / night: The switch-on brightness is approached. If a day / night distinction is parameterized for the switchon behavior, the corresponding value is approached.</li> </ul> No change: The current brightness value remains unchanged. |
| RGB                     | RGB-value   | Restriction: The parameter is only available, if <ul style="list-style-type: none"> <li>Action: Brightness value</li> </ul> Defines the RGB color value for the bit scene   |
| Brightness white        | 0 – 100 %   | Restriction: The parameter is only available, if <ul style="list-style-type: none"> <li>Action: Brightness value</li> <li>White channels / Automatic brightness control White: No</li> </ul> Defines the TW brightness for the bit scene.   |
| Color temperature white | 0 – 100 %   | Restriction: The parameter is only available, if <ul style="list-style-type: none"> <li>Action: Brightness value</li> <li>White channels / Mixing ratio of the white channels: Parameterizable</li> </ul> Definition of the cold white ratio of the white channels for the bitscene   |

Table 26: Bit scenes

### 8.2.5.4. Disabling functions

Two separate disable objects are available for each channel or channel group (e.g. RGB). These objects can be used to set the channel or channel group to a locked or unlocked state via a 1-bit group address. In the locked state, all objects except the lock objects are ignored. The other channels / channel groups can continue to be used and operated without restriction during this time.

Various actions can be carried out in conjunction with the disabling or enabling process:

- Dimm to brightness value
- Dimm to switch-on
- No change
- As before

When the locking functions are activated, the brightness value is changed at the speed of the absolute dimming.

Note: The function is shown here for the operating mode RGBCCT (as RGB Extended) with deactivated automatic white admixture, as this offers the maximum number of parameters. The parameters Color Temperature White are also shown here in Cold White %. The parameters can also be set in Kelvin if the parameter "Specification of mixing ratio between warm and cool white" is changed accordingly (see RGBCCT (as RGB-Extended) – White channels). For other operation modes the parameters for brightness, color selection, CW proportion are reduced accordingly.

Note: This tab is only available if parameter "Release locking functions" under Channel group / Releases is set to Yes

**RGB - disabling functions**

Enable disabling object 1  No  Yes

Enable disabling object 2?  No  Yes

|                           | Action        | RGB     | Brightness white | Colour temp. White |
|---------------------------|---------------|---------|------------------|--------------------|
| Disabling 1 - disable (1) | Fixed value ▼ | #F0A816 |                  |                    |
| Disabling 1 - enable (0)  | As before ▼   |         |                  |                    |

Figure 46: disabling functions

| Parameter               | Selection  | Description   |
|-------------------------|--|---|
| Disable function [1/2]  | Yes<br>No  | Release parameters and communication objects of the selected lock.  |
| Disable / enable        | Brightness value<br>Switch-on value<br>switch-on value day / night<br>No change<br>As before | Defines what happens during locking/unlocking in addition to the actual locking/unlocking of the channel (group) brightness: <ul style="list-style-type: none"> <li>• Brightness value: A parameterized brightness is approached.</li> <li>• Switch-on value or Switch-on value day / night: The switch-on brightness is approached. If a day / night distinction is parameterized for the switchon behavior, the corresponding value is approached.</li> <li>• No change: The current brightness value remains unchanged.</li> <li>• As before: When unlocking, the value that was active before locking is approached. When locking, the behavior corresponds to that of "No change"</li> </ul> |
| RGB                     | RGB-value  | Restriction: The parameter is only available if <ul style="list-style-type: none"> <li>• Enable / disable Action: Brightness value</li> </ul> Defines the RGB color value for the lock function   |
| Brightness white        | 0 – 100 %  | Restriction: The parameter is only available if <ul style="list-style-type: none"> <li>• Action: Brightness value</li> <li>• White channels / Automatic brightness control White: No</li> </ul> Defines the TW brightness for the disable function.   |
| Color temperature white | 0 – 100 %  | Restriction: The parameter is only available if <ul style="list-style-type: none"> <li>• Action: Brightness value</li> <li>• White channels / Mixing ratio of white channels: Parameterizable</li> </ul> Definition of the cold white ratio of the white channels for the disable function  |

Table 27: Disabling functions

### 8.2.5.5. Sequences

In all operating modes except single channel, up to five optionally predefined or freely definable sequences can be started or stopped by means of CO.

Note: The function is shown here for the operating mode RGBCCT (as RGB Extended) with deactivated automatic white admixture, as this offers the maximum number of parameters. The parameters Color Temperature White are also shown here in Cold White %. The parameters can also be set in Kelvin if the parameter "Specification of mixing ratio between warm and cool white" is changed accordingly (see RGBCCT (as RGB-Extended) – White channels). For other operation modes the parameters for brightness, color selection, CW proportion are reduced accordingly.

RGB - sequence 1

Behaviour with absolute / relative dimming / switching with switching object sequence 1 Execute action with fallback to sequence

Fallback time to sequence 1 1 minute

Behaviour with control object "Stop" sequence 1  Stop sequence  Switch off

---

Sequence 1 Custom sequence

Infinite loop sequence 1  No  Yes

Number of repetitions sequence 1 0

Behaviour after sequence 1 Switch off

Number of steps sequence 1 5

|        | Colour  | Hold time | Transition time to the next step | Brightness white | Colour temp. White |
|--------|---------|-----------|----------------------------------|------------------|--------------------|
| Step 1 | #2AE31A | 10 s      | 10 s                             |                  |                    |
| Step 2 | #95B513 | 10 s      | 10 s                             |                  |                    |
| Step 3 | #DE1C1C | 10 s      | 10 s                             |                  |                    |
| Step 4 | #2617CC | 10 s      | 10 s                             |                  |                    |
| Step 5 | #E80FA1 | 10 s      | 10 s                             |                  |                    |

Figure 47: Sequences

| Parameter  | Selection   | Description  |
|--|---|--|
| Behavior with absolute / relative dimming / switching with switch object | <ul style="list-style-type: none"> <li>Execute action with fallback to sequence</li> <li>Execute action without fallback to sequence</li> <li>Locked (No reaction)</li> </ul> | Defines the behavior for an Absolute / Relative dimming action or a switching action during a running sequence: <ul style="list-style-type: none"> <li>Execute action with fallback: The dimming/switching operation is executed, after a parameterized time has elapsed, the sequence is continued.</li> <li>Execute action without fallback: The sequence is aborted and the dimming/switching operation is executed.</li> <li>Locked (no reaction): The dimming/switching function is not executed</li> </ul> |
| Fallback time  | Various time durations between 1 minute and 24 hours  | Restriction: The parameter is only available, if <ul style="list-style-type: none"> <li>Behavior for absolute / relative dimming / switching with switch object: Execute action with fallback to sequence</li> </ul> Definition of the duration after which the sequence is continued after an interruption.   |
| Behavior with "Stop" control object                                      | <ul style="list-style-type: none"> <li>Stop sequence</li> <li>Switch off</li> </ul>   | Definition of what happens when Stop is written to the "Sequence start / stop" communication object: <ul style="list-style-type: none"> <li>Stop: sequence is stopped and current brightness values are retained</li> <li>Switch off: Sequence is stopped and channel group is switched off</li> </ul>   |

|                         |   |   |
|-------------------------|---|---|
| Sequence                | <ul style="list-style-type: none"> <li>• User-defined sequence</li> <li>• Predefined sequence</li> <li>• Random sequence</li> <li>• Random color temperature</li> </ul> | <p>Sequence Type Definition:</p> <ul style="list-style-type: none"> <li>• User defined: Free definition of steps with brightnesses and times</li> <li>• Predefined sequence: Selection of a predefined sequence</li> <li>• Random sequence: Channel brightnesses, as well as times (up to parameterized maximum values) randomly</li> <li>• Random color temperature: Similar to random sequence, but with defined steps</li> </ul> |
| Endless loop            | Yes<br>No   | <p>Restriction: The parameter is only available, if</p> <ul style="list-style-type: none"> <li>• Sequence: Not "Random sequence"</li> </ul> <p>Defines whether the sequence is to run in an endless loop (until aborted by CO Sequence Stop)</p>  |
| Numers of repetitions   | 0 - 255   | Defines how many times in a row the sequence should be repeated   |
| Behavior after sequence | Hold last value<br>Switch off<br>Start sequence 1<br>Start sequence 2<br>Start sequence 3<br>Start sequence 4<br>Start sequence 5                                       | <p>Defines what should happen after a sequence has finished:</p> <ul style="list-style-type: none"> <li>• Hold last value: Sequence is ended, brightnesses of the last step are kept</li> <li>• Switch off: Sequence is ended, channel group is switched off</li> <li>• Start sequence [1-5]: sequence is finished, a new one is started</li> </ul>   |
| Number of steps         | 2 - 5   | Defines the number of steps of a sequence   |
| Predefined sequence     | Div. operating mode dependent predefined sequences  | <p>Restriction: The parameter is only available, if</p> <ul style="list-style-type: none"> <li>• Sequenz: „Vordefinierte Sequenz“</li> </ul> <p>Selection of a predefined sequence. Their definitions can be found at the following tables</p>  |
| Total Sequence Duration | 1 – 65535 s   | Definition of how long a run of a predefined sequence should last (the hold and transition times are stored there relative to the total duration)   |
| Color                   | RGB-value   | Defines the RGB color value for a step of a sequence.   |
| Hold time               | 1 – 65535 s   | Defines the time for which a specific color value is held for the step of a sequence  |
| Transition time         | 1 – 65535 s   | Defines the dimming time for the transition from one step to the next   |
| Brighness white         | 0 – 100 %   | <p>Restriction: The parameter is only available, if</p> <ul style="list-style-type: none"> <li>• Sequenz: „Benutzerdefinierte Sequenz“</li> </ul> <p>Festlegung der TW-Helligkeit für den Schritt einer Sequenz.</p>  |
| Color temperature       | 0 – 100 %   | Definition of the TW brightness for the step of a sequence  |
| Maximum hold time       | 1 – 65535 s   | Definition of the maximum hold time for a random sequence. For each random step a random number between 0 and this max. dwell time is determined  |
| Maximum tansion time    | 1 – 65535 s   | Definition of the maximum transition time for a random sequence. For each random step, a random number between 0 and this maximum transition time is determined   |

Table 28: Sequences

| Name           | Steps | Repetitions | Step | R   | G   | B   | Holding time proportionate to total time [%] | Transition time proportionate to total Time [%] |
|----------------|-------|-------------|------|-----|-----|-----|--|---|
| Amber room     | 5     | 0           | 1    | 255 | 179 | 56  | 0  | 20  |
|                |       |             | 2    | 255 | 186 | 25  | 0  | 20  |
|                |       |             | 3    | 255 | 198 | 25  | 0  | 20  |
|                |       |             | 4    | 255 | 204 | 0   | 0  | 20  |
|                |       |             | 5    | 255 | 191 | 0   | 0  | 20  |
| Warm colors    | 2     | 0           | 1    | 255 | 0   | 132 | 0  | 50  |
|                |       |             | 2    | 251 | 255 | 0   | 0  | 50  |
| Cold colors    | 2     | 0           | 1    | 102 | 252 | 255 | 0  | 50  |
|                |       |             | 2    | 174 | 71  | 255 | 0  | 50  |
| Rainbow colors | 3     | 0           | 1    | 255 | 0   | 0   | 0  | 34  |
|                |       |             | 2    | 0   | 255 | 0   | 0  | 33  |
|                |       |             | 3    | 0   | 0   | 255 | 0  | 33  |
| TV             | 3     | 0           | 1    | 64  | 183 | 128 | 30   | 0   |
|                |       |             | 2    | 82  | 128 | 161 | 20   | 0   |
|                |       |             | 3    | 39  | 216 | 98  | 50   | 0   |
| Sunset         | 4     | 0           | 1    | 255 | 242 | 0   | 0  | 25  |
|                |       |             | 2    | 255 | 119 | 0   | 0  | 25  |
|                |       |             | 3    | 255 | 0   | 0   | 0  | 25  |
|                |       |             | 4    | 0   | 0   | 0   | 0  | 25  |
| Warp           | 2     | 2           | 1    | 0   | 0   | 219 | 20   | 40  |
|                |       |             | 2    | 0   | 179 | 224 | 0  | 40  |
| Stroboscope    | 2     | 5           | 1    | 255 | 255 | 255 | 50   | 0   |
|                |       |             | 2    | 0   | 0   | 0   | 50   | 0   |
| Good morning   | 4     | 0           | 1    | 0   | 0   | 0   | 0  | 40  |
|                |       |             | 2    | 51  | 128 | 0   | 0  | 40  |
|                |       |             | 3    | 94  | 61  | 43  | 0  | 15  |
|                |       |             | 4    | 255 | 242 | 230 | 5  | 0   |
| Glow           | 4     | 0           | 1    | 0   | 3   | 0   | 0  | 30  |
|                |       |             | 2    | 51  | 3   | 0   | 0  | 30  |
|                |       |             | 3    | 94  | 5   | 0   | 0  | 20  |
|                |       |             | 4    | 255 | 3   | 0   | 0  | 20  |
| Comfort        | 4     | 0           | 1    | 99  | 79  | 26  | 0  | 40  |
|                |       |             | 2    | 115 | 92  | 51  | 0  | 40  |
|                |       |             | 3    | 26  | 5   | 0   | 0  | 15  |
|                |       |             | 4    | 18  | 3   | 0   | 0  | 5   |

Table 29: RGB Sequences

| Name             | Anzahl an Schritten | Anzahl an Wiederholungen | Schritt | Rot | Grün | Blau | Haltezeit anteilig An Gesamtzeit [%] | Übergangszeit anteilig an Gesamtzeit [%] |
|------------------|---------------------|--------------------------|---------|-----|------|------|--------------------------------------|--|
| Red              | 2                   | 0                        | 1       | 153 | 61   | 61   | 0                                    | 50                                       |
|                  |                     |                          | 2       | 255 | 0    | 0    | 0                                    | 50                                       |
| Green            | 2                   | 0                        | 1       | 115 | 153  | 61   | 0                                    | 50                                       |
|                  |                     |                          | 2       | 149 | 255  | 0    | 0                                    | 50                                       |
| Railway station  | 2                   | 0                        | 1       | 102 | 128  | 128  | 0                                    | 50                                       |
|                  |                     |                          | 2       | 102 | 111  | 128  | 0                                    | 50                                       |
| Night light      | 2                   | 0                        | 1       | 51  | 24   | 15   | 0                                    | 50                                       |
|                  |                     |                          | 2       | 51  | 51   | 28   | 0                                    | 50                                       |
| Green und yellow | 2                   | 0                        | 1       | 125 | 255  | 125  | 0                                    | 50                                       |
|                  |                     |                          | 2       | 151 | 153  | 14   | 0                                    | 50                                       |

Table 30: RGB Sequences

| Name         | Anzahl an Schritten | Anzahl an Wiederholungen | Schritt | TW-Helligkeit | Anteil KW | Haltezeit anteilig An Gesamtzeit [%] | Übergangszeit anteilig an Gesamtzeit [%] |
|--------------|---------------------|--------------------------|---------|---------------|-----------|--------------------------------------|--|
| Sunrise      | 4                   | 0                        | 1       | 25            | 0         | 0                                    | 50                                       |
|              |                     |                          | 2       | 153           | 0         | 0                                    | 20                                       |
|              |                     |                          | 3       | 204           | 127       | 0                                    | 15                                       |
|              |                     |                          | 4       | 255           | 127       | 15                                   | 0  |
| Sunset       | 4                   | 0                        | 1       | 255           | 127       | 0                                    | 20                                       |
|              |                     |                          | 2       | 204           | 102       | 0                                    | 30                                       |
|              |                     |                          | 3       | 51            | 76        | 0                                    | 50                                       |
|              |                     |                          | 4       | 0             | 0         | 0                                    | 0  |
| Alarm        | 2                   | 0                        | 1       | 100           | 255       | 50                                   | 0  |
|              |                     |                          | 2       | 100           | 255       | 50                                   | 0  |
| Warp         | 3                   | 0                        | 1       | 127           | 0         | 20                                   | 20                                       |
|              |                     |                          | 2       | 204           | 127       | 0                                    | 20                                       |
|              |                     |                          | 3       | 127           | 0         | 20                                   | 20                                       |
| Stroboscope  | 2                   | 5                        | 1       | 255           | 127       | 50                                   | 0  |
|              |                     |                          | 2       | 0             | 127       | 50                                   | 0  |
| Candle light | 3                   | 0                        | 1       | 204           | 0         | 50 (*)                               | 5 (*)                                    |
|              |                     |                          | 2       | 255           | 10        | 20 (*)                               | 5 (*)                                    |
|              |                     |                          | 3       | 204           | 0         | 20 (*)                               | 0 (*)                                    |

Table 31: TW Sequences

(\*) For the TW sequence "Candlelight" the relative times represent maximum values. Random values between 0 and maximum value are determined for each sequence run



### 8.2.5.6. Time-controlled dimming or HCL

Note: The function is shown here for the operating mode RGBCCT (as RGB Extended) with deactivated automatic white admixture, as this offers the maximum number of parameters. The parameters Color Temperature White are also shown here in Cold White %. The parameters can also be set in Kelvin if the parameter "Specification of mixing ratio between warm and cool white" is changed accordingly (see RGBCCT (as RGB-Extended) – White channels). For other operation modes the parameters for brightness, color selection, CW proportion are reduced accordingly.

Note: This tab is only available if the time objects under General / Time functions are released, as well as the parameter "Release time-controlled dimming" under Approvals. In addition, the communication objects Date and Time must be written once for the correct function after the device start.

RGB - time-controlled dimming

**i** In order to be able to start time-controlled dimming, the date and time must be written once by means of a communication object after the device has been started.

Dimming behaviour  Smooth transition between two times  Abs. dimming process at the time

Note: There is no continuous transition between the last parameterised time and time 1, but the last brightness value is held and only dimmed absolutely to brightness value 1 at time 1.

---

Behaviour with absolute / relative dimming / switching with switching object Execute action with fallback to time-controlled dimming ▾

Fallback to time-controlled dimming 1 minute ▾

Behaviour with control object "Stop"  Stop sequence  Switch off

Number of times 7 ▾

Note: For the time, either fixed times or times dependent on sunrise or sunset can be set.

|        | Time       | RGB     | Brightness white | Colour temp. White |
|--------|------------|---------|------------------|--------------------|
| Time 1 | 06:00:00 ▾ | #A0B0B2 |                  |                    |
| Time 2 | 10:00:00 ▾ | #D5E8ED |                  |                    |
| Time 3 | 11:00:00 ▾ | #DBF2F4 |                  |                    |
| Time 4 | 12:00:00 ▾ | #E0F7F9 |                  |                    |
| Time 5 | 13:00:00 ▾ | #E0F7F9 |                  |                    |
| Time 6 | 14:00:00 ▾ | #DEF5F7 |                  |                    |
| Time 7 | 18:00:00 ▾ | #BCCFD1 |                  |                    |

Figure 48: HCL

| Parameter  | Selection   | Description  |
|--|---|--|
| Dimming behaviour  | <ul style="list-style-type: none"> <li>• Smooth transition between two points in time</li> <li>• Abs. dimming at time</li> </ul>  | <p>Defines the basic behavior of time-controlled dimming:</p> <p>Uniform transition:</p> <ul style="list-style-type: none"> <li>• Between two successive interpolation points, there is a uniform transition of the parameterized brightnesses.<br/>Exception: Between the last parameterized setpoint of a day and the first of the following day, the last brightness value is held instead and only dimmed absolutely to its brightness value at the time of the first setpoint of the following day.</li> <li>• Abs. dimming process at the time: When each setpoint is reached, its brightness is dimmed absolutely. The brightness is maintained between the setpoints.</li> </ul> |
| Behavior with absolute / relative dimming / switching with switch object | <ul style="list-style-type: none"> <li>• Execute action with fallback to time-controlled dimming</li> <li>• Execute action without fallback to time-controlled dimming</li> <li>• Locked (no reaction)</li> </ul> | <p>Defines the behavior for an Absolute / Relative dimming action or a switching action during a running sequence:</p> <ul style="list-style-type: none"> <li>• Execute action with fallback: The dimming/switching operation is executed, after a parameterized time has elapsed, the sequence is continued</li> <li>• Execute action without fallback: Time-controlled dimming is canceled and the dimming/switching operation is executed.</li> <li>• Locked (no reaction): The dimming/switching function is not executed</li> </ul>   |
| Fallback time to time-controlled dimming                                 | Various time durations between 1 minute and 24 hours.   | Definition of the duration after which the sequence is continued after an interruption.  |
| Behavior with "Stop" control object                                      | Stop sequence<br>Switch of  | <p>Definition of what happens when Stop is written to the "Time-controlled dimming start / stop" communication object:</p> <ul style="list-style-type: none"> <li>• Stop: Time-controlled dimming is stopped and current brightness values remain.</li> <li>• Switch off: Time-controlled dimming is stopped and channel group is switched off</li> </ul>  |
| Number of time Points  | 2 – 10  | Definition of the number of time points (interpolation points)   |
| Time   | Selection of a time<br>Sunrise +/- Offset<br>sunset +/- offset  | Definition of a control point  |
| RGB  | RGB-Wert  | Defining the value of the channels for a control point   |
| Bightness white  | 0 – 100 %   |  |
| Colortemperature white   | 0 – 100 %   |  |

Table 32: HCL

### 8.3. Communication objects

Note: Depending on the parameterization, some objects may not be available.

| ID | Name          | Object function                   | Description and approval   | Lenght  | DptTyp    |
|----|---------------|-----------------------------------|--|---------|-----------|
| 1  | Time          | Time                              | Set the time of the internal real-time clock. This is required for the time-controlled dimming functions and for automatic day/night switching.                          | 3 Bytes | DPST-10-1 |
| 2  |               | Date                              | Set the date of the internal real-time clock. This is required for the time-controlled dimming functions and for the astro function (calculation of sunrise and sunset). | 3 Bytes | DPST-11-1 |
| 3  |               | Date / time                       | Set time and date of the internal real-time clock (combined CO)  | 8 Bytes | DPST-19-1 |
| 4  |               | Day / night                       | Set the device to day or night mode. Depending on this, different switch-on brightnesses can be parameterized, for example (see parameter description).                  | 1 Bit   | DPST-1-24 |
| 6  | Relay         | Switch external mains relay       | Switch object for an external switch actuator for demand-dependent switching on/off of the LED power supply  | 1 Bit   | DPST-1-1  |
| 7  |               | Switch external mains Relay state | Status feedback object of the external switching contact   | 1 Bit   | DPST-1-1  |
| 8  | Alarm         | Undervoltage                      | Returns alarm (1) if the measured power supply voltage falls below the value of 4 V.   | 1 Bit   | DPST-1-5  |
| 9  |               | Overvoltage                       | Returns alarm (1) when the measured power supply voltage exceeds the value of 53 V   | 1 Bit   | DPST-1-5  |
| 10 |               | Overtemperature                   | Returns alarm (1) when the measured internal device temperature exceeds the value of 125°C   | 1 Bit   | DPST-1-5  |
| 11 |               | Overcurrent total                 | Returns alarm (1) when the measured current exceeds the value of 20 A  | 1 Bit   | DPST-1-5  |
| 12 |               | Overcurrent A                     |  | 1 Bit   | DPST-1-5  |
| 13 |               | Overcurrent B                     |  | 1 Bit   | DPST-1-5  |
| 14 |               | Overcurrent C                     |  | 1 Bit   | DPST-1-5  |
| 15 |               | Overcurrent D                     |  | 1 Bit   | DPST-1-5  |
| 16 | Overcurrent E | 1 Bit                             | DPST-1-5   |         |           |

|    |                 |   |  |         |            |
|----|-----------------|---|--|---------|------------|
| 20 | Measurement     | Current total   | Returns the measured total current   | 4 Bytes | DPST-14-19 |
| 21 |                 | Current channel A   | Returns the measured channel current   | 4 Bytes | DPST-14-19 |
| 22 |                 | Current channel B   |  | 4 Bytes | DPST-14-19 |
| 23 |                 | Current channel C   |  | 4 Bytes | DPST-14-19 |
| 24 |                 | Current channel D   |  | 4 Bytes | DPST-14-19 |
| 25 |                 | Current channel E   |  | 4 Bytes | DPST-14-19 |
| 26 |                 | Lamp voltage at start-up Channel A                          | Returns the measured voltage from 1-Touch-Commissioning for channel A. This measured value represents the voltage at the illuminant under full load.<br>For this, the parameters for the lines must be set in the Measurements and counters tab and the 1-touch commissioning must have been executed once via the display | 4 Bytes | DPST-14-27 |
| 27 |                 | Lamp voltage at start-up Channel B                          |  | 4 Bytes | DPST-14-27 |
| 28 |                 | Lamp voltage at start-up Channel C                          |  | 4 Bytes | DPST-14-27 |
| 29 |                 | Lamp voltage at start-up Channel D                          |  | 4 Bytes | DPST-14-27 |
| 30 |                 | Lamp voltage at start-up Channel E                          |  | 4 Bytes | DPST-14-27 |
| 31 |                 | Device temperature  | Returns the measured internal device temperature.  | 4 Bytes | DPST-14-68 |
| 32 |                 | Average telegram rate (T/s) sent over the last minute       | Returns the maximum / average telegram rate (telegrams per second) of the telegrams sent by device within the last minute  | 2 Bytes | DPST-7-1   |
| 33 |                 | Average telegram rate (T/s) sent over the last 5 minutes    |  | 2 Bytes | DPST-7-1   |
| 34 |                 | Average telegram rate (T / s) sent over the last 15 minutes |  | 2 Bytes | DPST-7-1   |
| 35 |                 | Max. Telegram rate (T / s) sent within the last minute      |  | 2 Bytes | DPST-7-1   |
| 36 |                 | Max. Telegram rate (T / s) sent within the last 5 minutes   |  | 2 Bytes | DPST-7-1   |
| 37 |                 | Max. Telegram rate (T / s) sent within the last 15 minutes  |  | 2 Bytes | DPST-7-1   |
| 38 |                 | Power supply voltage  | Gibt die am Eingang (LED-Netzteil) gemessene Spannung zurück.<br>Freigabe: Parameter „Objektfreigabe“ unter Messungen und Zähler / Messungen   | 4 Bytes | DPST-14-27 |
| 39 |                 | Power total   | Returns the (total) power expected from the power supply voltage and total current   | 4 Bytes | DPST-14-56 |
| 40 |                 | Power channel A   |  | 4 Bytes | DPST-14-56 |
| 41 |                 | Power channel B   |  | 4 Bytes | DPST-14-56 |
| 42 |                 | Power channel C   |  | 4 Bytes | DPST-14-56 |
| 43 |                 | Power channel D   |  | 4 Bytes | DPST-14-56 |
| 44 | Power channel E | 4 Bytes   | DPST-14-56   |         |            |

|    |       |  |  |   |            |
|----|-------|--|--|---|------------|
| 45 | Meter | Absorbed energy lifetime total   | Returns the energy absorbed by the power supply. The average efficiency of the LED power supply unit parameterized under Counter is included here. The value refers to the entire lifetime of the device and cannot be reset.  | 4 Bytes   | DPST-13-10 |
| 46 |       | Absorbed energy lifetime channel A   | Analogous to CO "Total Absorbed Energy Lifetime", but reduced to the energy absorbed by channel X. For the operating modes RGBCCT, RGBW, or RGB, the CO stores the energy value of the entire channel group  | 4 Bytes   | DPST-13-10 |
| 47 |       | or<br>Absorbed energy lifetime channel RGBCCT  |  | 4 Bytes   | DPST-13-10 |
| 48 |       | resp.<br>Recorded energy lifetime channel RGBW   |  | 4 Bytes   | DPST-13-10 |
| 49 |       | resp.<br>Absorbed energy lifetime channel RGB  |  | 4 Bytes   | DPST-13-10 |
| 50 |       | Absorbed energy lifetime channel E<br>or.<br>Absorbed energy lifetime channel TW 2                                     |  | Analogous to CO "Absorbed energy lifetime total", but reduced to the energy absorbed by channel E. For the Tunable White operating mode, the CO stores the energy value of the TW 2 channel group | 4 Bytes    |
| 51 |       | Absorbed energy since last analysis reset Total  | Analogous to CO "Total absorbed energy lifetime", but with a different analysis interval that can be reset using CO "Perform analysis reset"   | 4 Bytes   | DPST-13-10 |
| 52 |       | Absorbed energy since last analysis reset Channel A  | Analogous to CO "Absorbed energy since last analysis reset total", but reduced to the energy absorbed by channel X. For the operating modes RGBCCT, RGBW, or RGB, the CO stores the energy value of the entire channel group   | 4 Bytes   | DPST-13-10 |
| 53 |       | or<br>Absorbed energy since last analysis reset RGBCCT   |  | 4 Bytes   | DPST-13-10 |
| 54 |       | or<br>Absorbed energy since last analysis reset RGBW   |  | 4 Bytes   | DPST-13-10 |
| 55 |       | or<br>Absorbed energy since last analysis set RGB  |  | 4 Bytes   | DPST-13-10 |
| 56 |       | or<br>Absorbed energy since last analysis set RGB  |  | 4 Bytes   | DPST-13-10 |
| 57 |       | Costs lifetime total   | Returns the cost (in ct) of the energy absorbed by the network. The average efficiency of the LED power supply unit parameterized under Counter and the electricity price parameterized there are included here. The value refers to the entire lifetime of the device and cannot be reset | 4 Bytes   | DPST-13-1  |
| 58 |       | Costs lifetime channel A<br>or<br>Costs lifetime RGBCCT<br>resp.<br>Costs lifetime RGBW<br>resp.<br>Costs lifetime RGB | Analogous to CO "Costs lifetime total", but reduced to the costs generated by channel A. For the operating modes RGBCCT, RGBW, or RGB, the CO stores the counter reading of the entire channel group   | 4 Bytes   | DPST-13-1  |

Table 33: Communication objects

|    |  |   |  |           |           |
|----|--|---|--|-----------|-----------|
| 59 | Meter                                  | Cost lifetime channel X   | Analogous to CO "Cost lifetime total", but reduced to the costs generated by channel B   | 4 Bytes   | DPST-13-1 |
| 60 |  |   |  | 4 Bytes   | DPST-13-1 |
| 61 |  |   |  | 4 Bytes   | DPST-13-1 |
| 62 |  |   |  | 4 Bytes   | DPST-13-1 |
| 63 |  | Costs since last analysis reset total   | Analogous to CO "Total lifetime costs", but with a different analysis interval that can be reset using CO "Perform analysis reset"   | 4 Bytes   | DPST-13-1 |
| 64 |  | Costs since last analysis reset channel X or<br>Costs since last analysis reset RGBCCT resp.<br>Costs since last analysis set RGBW resp.<br>Costs since last analysis set RGB   | Analogous to CO "Costs since last analysis reset total", but reduced to the costs generated by channel X. For the operating modes RGBCCT, RGBW, or RGB, the CO stores the counter reading of the entire channel group  | 4 Bytes   | DPST-13-1 |
| 65 |  |   |  | 4 Bytes   | DPST-13-1 |
| 66 |  |   |  | 4 Bytes   | DPST-13-1 |
| 67 |  |   |  | 4 Bytes   | DPST-13-1 |
| 68 |  | 4 Bytes   | DPST-13-1  |           |           |
| 69 | Perform analysis reset                 | Resets the energy and cost counters with the extension "since last analysis reset" to 0   | 1 Bit  | DPST-1-17 |           |
| 70 | Electricity price (0.01 cents per kWh) | This CO can be used to transfer a price that deviates from the parameterized electricity price. The value is retained until the next reprogramming and is specified in hundredths of a cent per kWh → Ex.:<br>The transfer of 3111 results in an electricity price of 31.11 cents / kWh | 2 Bytes  | DPST-7-1  |           |
| 75 | Illuminant protection                  | Channel X continuous power exceeded or<br>Channel RGBCCT Continuous power exceeded resp.<br>Channel RGBW Continuous power exceeded resp.<br>Channel RGB Continuous power exceeded   | Returns alarm (1) if the value "Continuous power" parameterized under Alarm objects and protection functions / Illuminant protection is exceeded. Depending on the operating mode, the CO affects channel A (single channel mode) or the channel group RGBCCT, or RGBW, or RGB   | 1 Bit     | DPST-1-5  |
| 76 |  |   |  | 1 Bit     | DPST-1-5  |
| 77 |  |   |  | 1 Bit     | DPST-1-5  |
| 78 |  |   |  | 1 Bit     | DPST-1-5  |
| 79 |  |   |  | 1 Bit     | DPST-1-5  |
| 80 |  |   |  | 1 Bit     | DPST-1-5  |
| 81 |  | Channel X I <sup>2</sup> t value exceeded   | Returns alarm (1) if the I <sup>2</sup> t threshold for channel X configured under alarm objects and protection functions / light protection is exceeded. Notes on I <sup>2</sup> t shutdown can be found in the Illuminant protection chapter. Depending on the operating mode, the CO affects channel A (single channel mode) or the channel group RGBCCT, or RGBW, or RGB | 1 Bit     | DPST-1-5  |
| 82 |  |   |  | 1 Bit     | DPST-1-5  |
| 83 |  |   |  | 1 Bit     | DPST-1-5  |
| 84 |  |   |  | 1 Bit     | DPST-1-5  |
| 85 |  | Channel X maximum power exceeded or<br>Channel RGBCCT maximum power exceeded or<br>Channel RGBW maximum power exceeded or<br>Channel RGB maximum power exceeded   | Channel RGB maximum power exceeded Returns alarm (1) if the value configured under alarm objects and protection functions / light protection is exceeded. Depending on the operating mode, the CO affects channel A (single channel mode) or the channel group RGBCCT, or RGBW, or RGB   | 1 Bit     | DPST-1-5  |
| 86 |  |   |  | 1 Bit     | DPST-1-5  |
| 87 |  |   |  | 1 Bit     | DPST-1-5  |
| 88 |  |   |  | 1 Bit     | DPST-1-5  |
| 89 | 1 Bit                                  |   |  | DPST-1-5  |           |

|           |                                |  |   |           |           |
|-----------|--------------------------------|--|---|-----------|-----------|
| 95        | Power supply protection        | Power supply continuous power exceeded   | Returns alarm (1) if the "Continuous power" value parameterized under Alarm objects and protective functions / Power supply protection is exceeded.   | 1 Bit     | DPST-1-5  |
| 96        |                                | Power supply I <sup>2</sup> t value exceeded   | Returns alarm (1) if the I <sup>2</sup> t threshold parameterized under Alarm objects and protective functions /Power supply protection is exceeded. Notes on I <sup>2</sup> t shutdown can be found in the Power supply protection chapter.  | 1 Bit     | DPST-1-5  |
| 97        |                                | Power supply maximum power exceeded  | Returns alarm (1) if the value "Continuous power" + overload capability (= maximum power) parameterized under Alarm objects and protective functions / Power supply protection is exceeded  | 1 Bit     | DPST-1-5  |
| 101       | Channel A                      | Switch   | Switch channel A. The switching behavior (switchon behavior (brightness value, switch-on speed, etc.) or corresponding switch-off behavior) depends on the parameterization   | 1 Bit     | DPST-1-1  |
| 102       |                                | stairway lighting  | Switch channel A stairway lighting. The switch-on behavior (brightness value, switch-on speed, etc.) depends on the parameterization. Switching off the stairway lighting can be prevented by means of the parameter "Allow switch-off by CO" under Individual channel / Stairway lighting function.  | 1 Bit     | DPST-1-1  |
| 103       |                                | Stairway lighting time factor  | This CO can be used to assign a factor to the time defined under the "Stairway lighting activation time" parameter. If the parameter "Activate stairway lighting function via stairway lighting time object" under Individual channel / Stairway lighting function is set to Yes, the stairway lighting function is also started immediately when a factor is sent. | 1 Byte    | DPST-5-10 |
| 104       |                                | Dimming absolute   | Dim channel A absolutely to a percentage value  | 1 Byte    | DPST-5-1  |
| 105       |                                | Dimming relative   | Dim channel A relatively to a percentage value  | 4 Bit     | DPST-3-7  |
| 106       |                                | Disabling 1  | Activates the disabling function  | 1 Bit     | DPST-1-1  |
| 107       |                                | Disabling 2  |   | 1 Bit     | DPST-1-1  |
| 108       |                                | Scene  | Activate channel A scene or save current brightness value for scene (the latter only if parameterized accordingly under "Release saving" under Individual channel / Scenes.   | 1 Byte    | DPST-18-1 |
| 109       |                                | Bit Scene  | Enable / disable channel A bit scene  | 1 Bit     | DPST-1-1  |
| 110       |                                |  |   | 1 Bit     | DPST-1-1  |
| 111       |                                |  |   | 1 Bit     | DPST-1-1  |
| 112       |                                |  |   | 1 Bit     | DPST-1-1  |
| 113       |                                |  |   | 1 Bit     | DPST-1-1  |
| 114       |                                | Time-controlled dimming Start / Stop   | Start / stop time-controlled dimming.   | 1 Bit     | DPST-1-10 |
| 115       |                                | Status On/Off  | Status object, indicates whether channel A is ON (for brightness values greater than 0) or OFF  | 1 Bit     | DPST-1-1  |
| 116       |                                | Status Brightness  | Status object shows channel brightness as value 0 - 100   | 1 Byte    | DPST-5-1  |
| 117       |                                | Status Disabling   | Status object, shows whether channel A is locked (1 for locked)   | 1 Bit     | DPST-1-1  |
| 118       | Status time-controlled dimming | Status object, indicates whether time-controlled dimming is currently active for channel A (1 for active). | 1 Bit   | DPST-1-11 |           |
| 121 - 198 | Channel B – E                  | Channel B – Channel E analog to Channel A  | Channel B – Channel E analog to Channel A   |           |           |

|     |     |                                       |   |         |             |
|-----|-----|---------------------------------------|---|---------|-------------|
| 201 | RGB | Switching                             | Switch RGB(CCT/W) channel group. The switching behavior (switch-on behavior (brightness value, switch-on speed, etc.) or corresponding switch-off behavior) depends on the parameterization.  | 1 Bit   | DPST-1-1    |
| 202 |     | Switch stairway lighting              | Switch RGB(CCT/W) channel group stairway lighting. The switch-on behavior (brightness value, switch-on speed, etc.) depends on the parameterization. Switching off the stairway lighting can be prevented by means of the parameter "Allow switch- off by CO" under RGB(CCT/W) / Stairway lighting function.  | 1 Bit   | DPST-1-1    |
| 203 |     | Stairway lighting factor              | This CO can be used to assign a factor to the time defined under the "Stairway lighting activation time" parameter. If the parameter "Activate stairway lighting function via stairway lighting time object" under RGB(CCT/W) / Stairway lighting function is set to Yes, the stairway lighting function is also started immediately when a factor is sent.   | 1 Byte  | DPST-5-10   |
| 204 |     | Store maximum brightness Start / Stop | By sending 0 to this CO, the current brightness values are stored as maximum values for the respective channels of the RGB(CCT/W) channel group. From this point on, the default values are scaled accordingly.<br>By sending 1 to this CO, the stored maximum values for the respective channels of the channel group are reset to Maximum brightness (255).<br>Release: "Limit maximum brightness" parameter under RGB(CCT/W) / Configuration to "CO"                       | 1 Bit   | DPST-1-10   |
| 205 |     | Dimming absolute R                    | Dim channel red absolute to a percentage value.   | 1 Byte  | DPST-5-1    |
| 206 |     | Dimming absolute G                    | Dim channel green absolute to a percentage value.   | 1 Byte  | DPST-5-1    |
| 207 |     | Dimming absolute B                    | Dim channel blue absolute to a percentage value.  | 1 Byte  | DPST-5-1    |
| 208 |     | Dimming absolute W                    | Dim channel white absolute to a percentage value.   | 1 Byte  | DPST-5-1    |
| 210 |     | Dimming absolute RGBW                 | Dim channel group RGCCT or RGBW absolutely. For RGBW, the four individual values correspond to the brightnesses for red, green, blue and white; for RGCCT, the transferred white value refers to the TW brightness (see CO "TW 1 Dimming absolute brightness").   | 6 Bytes | DPST-251600 |
| 211 |     | Dimming absolute RGB                  | Dim red/green/blue values of a RGCCT, RGBW or RGB channel group absolutely.   | 3 Bytes | DPST-232600 |
| 212 |     | Dimming absolute HSV                  | Dim Hue/Saturation/Value values of a RGCCT, RGBW or RGB channel group absolutely (explanation see chapter Color spaces RGB and HSV).<br>Release: Always available if the channel group RGCCT, RGBW or RGB is released.<br>Note: If the CO is described from the ETS group monitor, the RGB ColorPicker appears there. The transmitted value, (e.g. #00FFFF), is not interpreted as RGB, but as HSV, which in the example results in H=0°, S=100% and V=100%, i.e. a pure red. | 3 Bytes | DPST-232600 |
| 213 |     | Dimming absolute H                    | Hue value of a RGCCT, RGBW or RGB channel group absolutely (explanation see chapter Color spaces RGB and HSV).  | 1 Byte  | DPST-5-3    |
| 214 |     | Dimming absolute S                    | saturation value of a RGCCT, RGBW or RGB channel group absolutely (explanation see chapter Color spaces RGB and HSV).   | 1 Byte  | DPST-5-1    |
| 215 |     | Dimming absolute V                    | Dim value of a RGCCT, RGBW or RGB channel group absolutely (explanation see chapter Color spaces RGB and HSV).  | 1 Byte  | DPST-5-1    |
| 216 |     | Dimming relative R                    | Dim channel red relatively to a percentage value.   | 4 Bit   | DPST-3-7    |
| 217 |     | Dimming relative G                    | Dim channel green relatively to a percentage value.   | 4 Bit   | DPST-3-7    |
| 218 |     | Dimming relative B                    | Dim channel blue relatively to a percentage value.  | 4 Bit   | DPST-3-7    |
| 219 |     | Dimming relative W                    | Dim channel white relatively to a percentage value.   | 4 Bit   | DPST-3-7    |
| 221 |     | Dimming relative RGBW                 | Relatively dim channel group RGCCT or RGBW. With RGBW, the four individual values correspond to the brightness levels for red, green, blue and white; with RGCCT, the transferred values for white relate to the TW brightness (see CO "TW 1 dimming absolute brightness").   | 5 Bytes | DPST-252600 |
| 222 |     | Dimming relative RGB                  | Relatively dim red / green / blue values of an RGCCT, RGBW or RGB channel group   | 3 Bytes | DPST-254600 |
| 223 |     | Dimming relative HSV                  | Relatively dim Hue/Saturation/Value of an RGCCT, RGBW or RGB channel group  | 3 Bytes | DPST-254600 |



|     |             |   |   |             |           |
|-----|-------------|---|---|-------------|-----------|
| 224 | RGB         | Dimming relative H  | Relatively dim Hue of an RGBCCT, RGBW or RGB channel group  | 4 Bit       | DPST-3-7  |
| 225 |             | Dimming relative S  | Relatively dim Saturation of an RGBCCT, RGBW or RGB channel group   | 4 Bit       | DPST-3-7  |
| 226 |             | Dimmen Relativ V  | Relatively dim Value of an RGBCCT, RGBW or RGB channel group  | 4 Bit       | DPST-3-7  |
| 227 |             | Disabling 1   | Activates the disabling function  | 1 Bit       | DPST-1-1  |
| 228 |             | Disabling 2   |   | 1 Bit       | DPST-1-1  |
| 229 |             | Scene   | Activate channel A scene or save current brightness value for scene (the latter only if parameterized accordingly under "Release saving" under Individual channel / Scenes. | 1 Byte      | DPST-18-1 |
| 230 |             | Bit Scene   | Enable / disable channel X bit scene X.   | 1 Bit       | DPST-1-1  |
| 231 |             |   |   | 1 Bit       | DPST-1-1  |
| 232 |             |   |   | 1 Bit       | DPST-1-1  |
| 233 |             |   |   | 1 Bit       | DPST-1-1  |
| 234 |             |   |   | 1 Bit       | DPST-1-1  |
| 235 |             | Status time-controlled dimming  | Status object, indicates whether time-controlled dimming is currently active for channel A (1 for active).  | 1 Bit       | DPST-1-10 |
| 236 |             | Sequence Start / Stop   | Start / stop sequence of channel group RGB (CCT / W).   | 1 Bit       | DPST-1-10 |
| 237 |             |   |   | 1 Bit       | DPST-1-10 |
| 238 |             |   |   | 1 Bit       | DPST-1-10 |
| 239 |             |   |   | 1 Bit       | DPST-1-10 |
| 240 |             |   |   | 1 Bit       | DPST-1-10 |
| 241 |             | Status On/Off   | Status object indicates whether the channel group RGB (CCT / W) is ON or OFF. It is ON when one or more channels in the channel group have a bright-ness greater than 0.    | 1 Bit       | DPST-1-1  |
| 242 |             | Status R  | Status object shows the channel brightness of the red channel as a value 0 - 255.   | 1 Byte      | DPST-5-1  |
| 243 |             | Status G  | Status object shows the channel brightness of the greeb channel as a value 0 - 255.   | 1 Byte      | DPST-5-1  |
| 244 | Status B    | Status object shows the channel brightness of the blue channel as a value 0 - 255.  | 1 Byte  | DPST-5-1    |           |
| 245 | Status W    | Status object shows the channel brightness of the white channel as a value 0 - 255.   | 1 Byte  | DPST-5-1    |           |
| 247 | Status RGBW | Status object shows the channel brightnesses of the channels red, green, blue and white; with RGBCCT the value for white refers to the TW brightness.             | 6 Bytes   | DPST-251600 |           |
| 248 | Status RGB  | Status object shows the channel brightnesses of the channels red, green and blue. Release: Always available if the channel group RGBCCT, RGBW or RGB is released. | 3 Bytes   | DPST-232600 |           |
| 249 | Status HSV  | Status object shows Hue / Saturation / Value values of an RGBCCT, RGBW or RGB channel group (see Color spaces RGB and HSV).                                       | 3 Bytes   | DPST-232600 |           |

Table 34: Communication objects

|     |      |  |  |  |             |           |
|-----|------|--|--|--|-------------|-----------|
| 250 | RGB  | Status H   | Status object shows the H value of an RGB CCT, RGBW or RGB channel group (see Color spaces RGB and HSV).   | 1 Byte   | DPST-5-3    |           |
| 251 |      | Status S   | Status object shows the S value of an RGB CCT, RGBW or RGB channel group (see Color spaces RGB and HSV).   | 1 Byte   | DPST-5-1    |           |
| 252 |      | Status V   | Status object shows the V value of an RGB CCT, RGBW or RGB channel group (see Color spaces RGB and HSV).   | 1 Byte   | DPST-5-1    |           |
| 253 |      | Status Disabling   | Status object, indicates whether RGB(CCT/W) channel group is locked (1 for locked).  | 1 Bit  | DPST-1-1    |           |
| 254 |      | Status Time-controlled dimming                                 | Status object, indicates whether time-controlled dimming for channel group RGB(CCT/W) is currently active (1 for active).  | 1 Bit  | DPST-1-11   |           |
| 255 |      | Sequence   |  | Status object, indicates whether sequence 1 for channel group RGB(CCT/W) is currently active (1 for active). | 1 Bit       | DPST-1-11 |
| 256 |      |  |  |  | 1 Bit       | DPST-1-11 |
| 257 |      |  |  |  | 1 Bit       | DPST-1-11 |
| 258 |      |  |  |  | 1 Bit       | DPST-1-11 |
| 259 |      |  |  |  | 1 Bit       | DPST-1-11 |
| 262 | TW 1 | Switching  | Switch channel group. The switching behavior (switch-on behavior (brightness value, switch-on speed, etc.) or corresponding switch-off behavior) depends on the parameterization.  | 1 Bit  | DPST-1-1    |           |
| 263 |      | Stairway lightning factor                                      | Switch stairway lighting channel group. The switch-on behavior (brightness value, switch-on speed, etc.) depends on the parameterization. Switching off the stairway lighting can be prevented by means of the parameter "Allow switch-off by CO" under TW 1 / Stairway lighting function.   | 1 Bit  | DPST-1-1    |           |
| 264 |      | Stairway lightning factor                                      | This CO can be used to apply a factor to the time defined under the "Stairway lighting activation time" parameter. If the parameter "Activate stairway lighting function via stairway lighting time object" under TW 1 / Stairway lighting function is set to Yes, the stairway lighting function is also started immediately when a factor is sent. | 1 Byte   | DPST-5-10   |           |
| 265 |      | Dimming absolute brightness                                    | Dim brightness of TW channel group absolutely.   | 1 Byte   | DPST-5-1    |           |
| 266 |      | Dimming absolute color temperature (Portion CW in %)           | Dim cold white part of channel group absolutely.   | 1 Byte   | DPST-5-1    |           |
| 267 |      | Dimming absolute color temperature (Kelvin)                    |  | 2 Bytes  | DPST-7-600  |           |
| 268 |      | Dimming absolute transition (brightness and color temperature) | Combined object for simultaneous change (absolute dimming) of brightness and color temperature.  | 6 Bytes  | DPST-249600 |           |
| 269 |      | Dimming relative brightness                                    | Dim brightness of TW channel group relatively.   | 4 Bit  | DPST-3-7    |           |
| 270 |      | Dimming relative color temperature (Portion CW in %)           | Dim cold white part of channel group relatively.   | 4 Bit  | DPST-3-7    |           |
| 271 |      | Dimming relative transition (brightness and color temperature) | Combined object for simultaneous changing (rel. dimming) of brightness and color temperature.  | 3 Bytes  | DPST-250600 |           |
| 272 |      | Disabling 1  | Activates the disabling function   | 1 Bit  | DPST-1-1    |           |
| 273 |      | Disabling 2  |  | 1 Bit  | DPST-1-1    |           |
| 274 |      | Scene  | Activate channel A scene or save current brightness value for scene (the latter only if parameterized accordingly under "Release saving" under Individual channel / Scenes.  | 1 Byte   | DPST-18-1   |           |

|           |       |   |  |           |            |
|-----------|-------|---|--|-----------|------------|
| 275       | TW 1  | Bit Scene                                     | Enable / disable channel X bit scene X.  | 1 Bit     | DPST-1-1   |
| 276       |       |   |  | 1 Bit     | DPST-1-1   |
| 277       |       |   |  | 1 Bit     | DPST-1-1   |
| 278       |       |   |  | 1 Bit     | DPST-1-1   |
| 279       |       |   |  | 1 Bit     | DPST-1-1   |
| 280       |       | HCL Start / Stop                              | HCL (= Human Centric Lighting = time-controlled dimming of a TW channel group) start / stop.   | 1 Bit     | DPST-1-10  |
| 281       |       | Sequence Start / Stop                         | Start / stop sequence 1 of channel group TW 1.   | 1 Bit     | DPST-1-10  |
| 282       |       |   |  | 1 Bit     | DPST-1-10  |
| 283       |       |   |  | 1 Bit     | DPST-1-10  |
| 284       |       |   |  | 1 Bit     | DPST-1-10  |
| 285       |       |   |  | 1 Bit     | DPST-1-10  |
| 286       |       | Status On/Off                                 | Status object indicates whether the channel group TW 1 is ON or OFF. It is ON if one or more channels of the channel group have a brightness greater than 0. | 1 Bit     | DPST-1-1   |
| 287       |       | Status brightness                             | Status object shows the brightness of the TW channel group   | 1 Byte    | DPST-5-1   |
| 288       |       | Status color temperature (portion CW in %)    | Status object displays the mixing ratio of the TW channel group in %.  | 1 Byte    | DPST-5-1   |
| 289       |       | Status color temperature (Kelvin)             | Status object displays the mixing ratio of the TW channel group in Kelvin.   | 2 Bytes   | DPST-7-600 |
| 290       |       | Status Disabling                              | Status object, indicates whether TW channel group is locked (1 for locked).  | 1 Bit     | DPST-1-1   |
| 291       |       | Status HCL                                    | Status object, indicates whether HCL (= Human Centric Lighting = time-controlled dimming for TW channel group) is currently active (1 for active).           | 1 Bit     | DPST-1-11  |
| 292       |       | Status Sequenz                                | Status object, indicates whether sequence 1 for channel group TW 1 is currently active (1 for active).   | 1 Bit     | DPST-1-11  |
| 293       |       |   |  | 1 Bit     | DPST-1-11  |
| 294       |       |   |  | 1 Bit     | DPST-1-11  |
| 295       | 1 Bit |   |  | DPST-1-11 |            |
| 296       | 1 Bit |   |  | DPST-1-11 |            |
| 299 - 333 | TW 2  | TW 2 analog to TW 1, without RGBCCT extension |  |           |            |

Table 35: Communication objects

## 9. Firmware-Update

The device can be updated. Firmware can be easily updated

### 9.1. Display firmware version

The current version of the firmware can be read out from the device via the ETS.

- Execute right click on the device in the ETS
- Select "Info > Device info".
  - Firmware version is displayed behind the square brackets.
    - Example: ... [...] 1.3

### 9.2. Preparing firmware update

Requirements:

- Only the owner of the ETS software license and the ETS project may perform the firmware update.
- The device must not be protected by a BAU password.

### 9.3. Performing a firmware update

The update has to be performed with the JUNG firmware update tool. The JUNG firmware update tool can be downloaded from our website. Detailed information about the JUNG firmware update tool can be found in the corresponding manual.

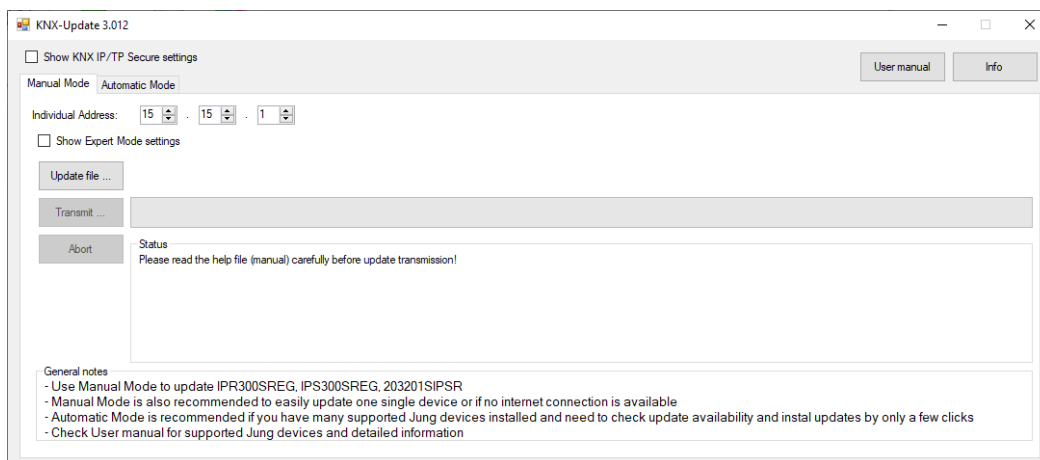

Figure 49: JUNG Update Tool

- Start JUNG firmware update.

#### Manual mode

- Enter individual address
- Select update file with button "Update File"
- Start update with transmit
- Update is performing automatically
- If necessary, reprogram the device via ETS.

#### Automatic mode

- Add desired line
- Narrow address range if necessary
- Scan line
- Select desired devices
- Press update button
- If necessary, reprogram the device via ETS.

## 10. Technical Data

|                             | 390051S LED E  | 390051S LED R  |
|-----------------------------|--|--|
| <b>Inputs</b>               | External power supply:<br>Voltage: 5 ... 48 V DC from operating device according to EN 61347-2-13 (or IEC 61347-2-13) with constant output voltage<br>Max. Current: 25 A. Alternatively a stronger power supply with an additional 25 A fuse at the output can be used.<br><br>KNX connection:<br>Voltage: 21 ... 32 V DC SELV<br>Current consumption < 30 mA  |  |
| <b>Outputs</b>              | 5 pulse width modulated DC voltage outputs for illuminants:<br>Voltage: 5 ... 48 V DC<br><br>Max. Current per channel at 5 ... 24 V:<br>Up to 488 Hz (recommended dimming frequency):<br>Channel A ... E at up to 50 m line length (I1 + I2): 15 A<br>Channel E at up to 13 m line length (I1 + I2): 20 A<br><br>600 Hz:<br>Channel A ... E at up to 50 m line length (I1 + I2): 12 A<br>Channel E at up to 13 m line length (I1 + I2): 20 A<br><br>832 Hz ... 1200 Hz:<br>Channel A ... E at up to 50 m line length (I1 + I2): 7 A<br>Channel E at up to 13 m line length (I1 + I2): 10 A<br><br>Max. Current per channel at 48 V:<br>50 % of the max. currents of 5 ... 24V<br>Max. Total current over all 5 channels at 5 ... 24 V: 20 A<br>Max. Total current over all 5 channels at 48 V: 10 A<br><br>Dimming frequency: 211 ... 1200 Hz, Recommended: 488 Hz | 5 pulse width modulated DC voltage outputs for illuminants:<br>Voltage: 5 ... 48 V DC<br><br>Max. Current per channel at 5 ... 24 V:<br>Up to 488 Hz (recommended dimming frequency):<br>Channel A ... E at up to 50 m line length (I1 + I2): 15 A<br>Channel A at up to 13 m line length (I1 + I2): 20 A<br><br>600 Hz:<br>Channel A ... E at up to 50 m line length (I1 + I2): 12 A<br>Channel E at up to 13 m line length (I1 + I2): 20 A<br><br>832 Hz ... 1200 Hz:<br>Channel A ... E at up to 50 m line length (I1 + I2): 7 A<br>Channel E at up to 13 m line length (I1 + I2): 10 A<br><br>Max. Current per channel at 48 V:<br>50 % of the max. currents of 5 ... 24V<br>Max. Total current over all 5 channels at 5 ... 24 V: 20 A<br>Max. Total current over all 5 channels at 48 V: 10 A<br><br>Dimming frequency: 211 ... 1200 Hz, Recommended: 488 Hz |
| <b>Protection functions</b> | Reverse polarity protection<br>Overcurrent shutdown (self-healing)<br>Overtemperature shutdown (self-healing)<br>Undervoltage shutdown (self-healing)<br>Overvoltage shutdown (self-healing)   |  |
| <b>Display elements</b>     | OLED Display<br>LEDs: „PROG“, „DC-POWER“, „POWER“<br>Button: „PROG“, „NEXT“, „SET“   |  |
| <b>Connections</b>          | DC voltage supply input:<br>Type: screw terminal, tightening force: 0.5 Nm<br>Conductor cross-section: 0.5 ... 4.0 mm <sup>2</sup> solid<br>Conductor cross-section: 0.5 ... 4.0 mm <sup>2</sup> finely stranded without ferrule<br>Conductor cross-section: 0.5 ... 2.5 mm <sup>2</sup> finely stranded with wire end ferrule<br><br>Pulse width modulated DC voltage outputs for illuminants:<br>Type: screw terminal, tightening force: 0.5 Nm<br>Conductor cross-section: 0.5 ... 4.0 mm <sup>2</sup> solid<br>Conductor cross-section: 0.5 ... 4.0 mm <sup>2</sup> finely stranded without ferrule<br>Conductor cross-section: 0.5 ... 2.5 mm <sup>2</sup> finely stranded with wire end ferrule<br><br>KNX connection:<br>Type: black / red connection terminal (type 5.1)<br>Conductor diameter: 0.8 mm solid conductor                                     |  |
| <b>Case</b>                 | Electronics housing with flange for screw mounting<br><br>Dimensions:<br>157,0 (136,0 without flange) x 45,0 x 25,5 mm (L x B x T)<br><br>Flammability class:<br>UL94-V0 (casing)<br>UL94-V2 (lid)   | DIN rail housing for 35 mm mounting rails width: 4 SU<br><br>Dimensions:<br>71,5 x 89,6 x 62,9 mm (L x B x H)<br><br>Flammability class:<br>UL94-V0 (casing)<br>UL94-V2 (lid)  |
| <b>Additional</b>           | For indoor use only<br>Only for installation in false ceilings, electrical sockets and on furniture, if not accessible<br>Highest ambient temperature $t_a = 45\text{ °C}$<br>Lowest ambient temperature $t_{a\text{ min}} = -5\text{ °C}$<br><br>Protection class III<br>Protection class: IP20<br><br>Audits:<br>KNX certified<br><br>Safety: Certificated<br>DIN EN 61347-2-13<br>IEC 63044-3<br><br>EMV: Certificated<br>IEC 63044-5-2 (Living area),<br>IEC 63044-5-3 (Industrial area),<br><br>Vicinity: Certificated DIN EN 50491-2   | For indoor use only<br>For operation in the control cabinet only<br><br>Highest ambient temperature $t_a = 45\text{ °C}$<br>Lowest ambient temperature $t_{a\text{ min}} = -5\text{ °C}$<br><br>Protection class III<br>Protection class: IP20<br><br>Audits:<br>KNX certified<br><br>Safety: Certificated<br>DIN EN 61347-2-13<br>IEC 63044-3<br><br>EMV: Certificated<br>IEC 63044-5-2 (Living area),<br>IEC 63044-5-3 (Industrial area),<br><br>Vicinity: Certificated DIN EN 50491-2   |

Table 36: Technical data